

# STORMWATER TECHNICAL MANUAL



KANE COUNTY

INTRODUCTION .....	3
PURPOSE .....	3
ORGANIZATION .....	4
PART 1 – TECHNICAL GUIDANCE .....	5
ARTICLE II - STORMWATER MANAGEMENT PERMIT SUBMITTAL REQUIREMENTS .....	6
§ T9-28 General Requirements .....	6
ARTICLE III - EROSION AND SEDIMENT CONTROL .....	7
§ T9-58 Applicability .....	7
§ T9-59 Erosion and Sediment Control .....	7
ARTICLE IV – REQUIREMENTS FOR STORMWATER MANAGEMENT .....	15
§ T9-81 General Information .....	15
§ T9-82 General Stormwater Requirements .....	28
§ T9-83 Site Runoff Requirements .....	28
ARTICLE V – REQUIREMENTS FOR STORMWATER MITIGATION / BEST MANAGEMENT PRACTICES (BMPS) AND WATERSHED BENEFIT MEASURES .....	65
§ T9-107 Requirements for Stormwater Mitigation / BMPs .....	65
§ T9-108 Requirements for Watershed Benefit Measures .....	173
ARTICLE VI – REQUIREMENTS FOR FLOOD HAZARD AREAS AND BUILDING PROTECTION STANDARDS .....	178
§ T9-134 Statewide and Regional Permits .....	178
§ T9-135 Floodplain Management .....	178
§ T9-136 Floodplain, Regulatory Floodplain, Base Flood Elevation (BFE) and Regulatory Floodway Locations and Standards .....	178
§ T9-139 Building Protection Standards .....	180
§ T9-141 Compensatory Storage Volume Standards .....	186
§ T9-142 Floodway Standards .....	190
§ T9-144 Bridge and Culvert Standards .....	195
ARTICLE VII – REQUIREMENTS FOR WETLANDS, LINEAR WATERCOURSES, NON-LINEAR WATERBODIES, BUFFERS AND MITIGATION .....	197
§ T9-168 General .....	197
§ T9-169 Requirements for Wetland Delineation .....	197
§ T9-170 Mitigation Required .....	201
§ T9-171 Mitigation to Be Local .....	205
§ T9-172 Mitigation Requirements .....	205
§ T9-173 Wetland Mitigation Plan .....	207
§ T9-174 Mitigation Performance Standards .....	209
§ T9-175 Mitigation Monitoring .....	211
§ T9-177 Buffer Requirements .....	212
§ T9-179 Fee-in-Lieu of Wetland Mitigation .....	226
§ T9-180 Wetland Submittal .....	226
ARTICLE VIII – PERFORMANCE SECURITY .....	229
ARTICLE IX – LONG-TERM MAINTENANCE .....	230

§ T9-233	Incorporation of Long-Term Maintenance of Stormwater Facilities	
	230	
ARTICLE XI – ENFORCEMENT AND PENALTIES	.....	235
§ T9-286	Required Inspections	235
PART 2 – FORMS AND REFERENCE DOCUMENTS	.....	236
FORMS AND REFERENCE DOCUMENTS	.....	237
Declaration of Restriction and Covenant for Linear Watercourse, Non-Linear Waterbody, Wetland and Wetland Buffer Areas	.....	238
Declaration of Restriction and Covenant for Category I Stormwater Mitigation/Best Management Practices (BMPs)	.....	241
AASHTO Maximum Width for Linear Projects References	.....	291
Falling Head Percolation Test Procedure	.....	293



## **INTRODUCTION**

The Kane County Stormwater Technical Guidance Manual (Manual) is, as the name suggests, a technical guide to provide developers and applicants assistance in complying with the Stormwater Ordinance and the technical requirements of a stormwater permit application.

## **PURPOSE**

The purpose of the Technical Guidance Manual is to supplement the Kane County Stormwater Ordinance (Ordinance) by providing background, detail, and intent of the technical requirements in the Ordinance. This manual contains discussion, tables, figures and exhibits covering most of the topics found in the Ordinance to assist the applicant in preparing a complete Stormwater Permit Application. The examples illustrated in this Manual are general and attempt to cover the most common requirements. In practice there will be situations that arise in the design of a development that will not be directly related to one of the examples in this manual. The concepts illustrated can be applied to a variety of developments.

The Manual is linked directly to the Kane County Stormwater Management Ordinance by using the same Section numbers as those contained in the Ordinance, with a “T” added to the number.

The Manual is to facilitate implementation and provide guidance necessary to achieve the objectives and standards of the Ordinance. This document has no authority to mandate new criteria and provides a conservative approach for complying with the intent and letter of the criteria. Other techniques may exist that will meet the criteria with less effort or at a lower cost. The applicant accepts the burden of demonstrating the technical adequacy of the development design and is completely responsible for conformance with the criteria of the Ordinance.

The different technical requirements are further defined in this Manual by use of charts, tables and example problems.



## ORGANIZATION

The Manual is comprised of two parts:

**Part 1** – Technical guidance covering stormwater management criteria, floodplain criteria and permit application requirements; and

**Part 2** – Additional resources plus appendices.

**PART 1 – TECHNICAL GUIDANCE**



## ARTICLE II - STORMWATER MANAGEMENT PERMIT SUBMITTAL REQUIREMENTS

### § T9-28 General Requirements

To determine if a Stormwater Management Permit is required for a particular development, the developer should use the worksheet on the Kane County website.

In order to determine if the project is in or near the floodplain the developer must show the project location on the Flood Insurance Rate Map (FIRM), published by the Federal Emergency Management Agency (FEMA). Many of the FIRMs published by FEMA are from the early 1980's and have been restudied and revised. Therefore, the developer should request from the community or county the latest FIRM for the project area. Each community is responsible for maintaining the latest set of FIRMs for their jurisdictional area.

In order to determine if the project is in or near the developer must show the project location on Kane County ADID and National Wetland Inventory maps. These maps may be found at the links below:

ADID: <http://dewprojects.countyofkane.org/adid/index.htm>

NWI: <https://www.fws.gov/wetlands/data/mapper.html>

It is important to note that not all wetlands are identified by these maps. An on-site wetland delineation may be required by a Qualified Wetland Specialist to determine the presence or absence of wetlands on or within 100 ft of the Site.

The Ordinance includes exceptions from the necessity of obtaining a Stormwater Management Permit. Refer to Section 9-28 for the list.

Developments that do not require a Stormwater Management Permit are not excluded from obtaining all other appropriate stormwater management related approvals from federal, state and regional authorities. All Developments must provide Erosion and Sedimentation Control.

## ARTICLE III - EROSION AND SEDIMENT CONTROL

Erosion and sedimentation are naturally occurring geological phenomena. Land development activities have initiated more drastic, undesirable and damaging alterations in the natural cycle by accelerating the erosion – sedimentation process. The original natural vegetative cover of prairie grasses, trees and shrubs allowed only a minimal amount of soil to be eroded. But as soon as cover was disturbed, first by the plow, and more recently by development activities, the exposed ground surface has become subject to accelerated stormwater runoff and resultant soil erosion. The primary cause of soil erosion is the energy impact of the falling rain on the exposed soil.

Stream beds tend to build-up with sediment during the construction phase of development and then erode dramatically as the area stabilizes and runoff increases. As such, erosion interferes with water uses, degrades water quality, destroys natural plant growth and buries substrates important for fish feeding and spawning.

### § T9-58      Applicability

All developments within Kane County, regardless of size, are required to meet the regulations of this Article and are required to receive all other appropriate erosion and sediment control-related approvals from federal, state and regional authorities.

### § T9-59      Erosion and Sediment Control

#### Site Planning

The primary goal of any erosion and sediment control site plan should be to prevent soil erosion by minimizing the amount of bare soil exposed at any one time during construction. On-site sediment control is a secondary mechanism to prevent eroded soil from leaving the development site. Soil erodibility factors have been calculated for all soil types in the County and may be found by consulting the Natural Resources Conservation Service's Field Office Technical Guidance (eFOTG), which can be accessed here:  
<https://efotg.sc.egov.usda.gov/#/details>

or by consulting the Natural Resources Conservation Service's Web Soil Survey, which is located here:  
<https://websoilsurvey.sc.egov.usda.gov/App/HomePage.htm>

The potential erodibility of surface soil becomes greater with an increase in the erodibility co-efficient (k) used. Soil type information will provide assistance to the designer in selection of appropriate management practices for both temporary and permanent stabilization.

From current Field Office Technical Guide

Risk	K
Low	< .25
Mod	.25 - .30
High	.30 - .35
Very High	> .35

Phased Construction

When site vegetation is inadequate to stabilize areas not currently being constructed in a phased development, several options are available for vegetative stabilization.

- 1) If construction will occur within one year, the site may be planted with a temporary cover of annual grasses, as listed in the Illinois Urban Manual, latest edition, or the Standard Specifications for Road and Bridge Construction, latest edition.
- 2) If construction of the phase will be greater than 1 year, stabilization may be accomplished with a cover that uses a mix of annual and perennial grasses, as listed in the Illinois Urban Manual, latest edition, or the Standard Specifications for Road and Bridge Construction, latest edition.

Erosion control methods should be appropriate for the size of site, the duration of construction, and the slope, length, and grade. Soil stabilization with vegetative cover is generally the most effective stabilization. Hydroseeding with mulch application or periodic hydromulching may be used for soil stabilization on slopes flatter than 3:1. When hydroseeding does not produce dense vegetation, areas should be re-seeded periodically until growth occurs or if short duration summer stabilization is required and hydroseeding should be supplemented with heavy hydromulching. For steep slopes and drainage ways, erosion control blankets may be more appropriate.

Standards and Specifications

The “Illinois Urban Manual: An Erosion and Sediment Control Best Management Practice Manual” is the primary resource for design detail for effective erosion and sediment control.

The “Illinois Urban Manual” can be accessed at the following link:

[http://www.aiswcd.org/wp-content/uploads/2013/06/IUM\\_June20131.pdf](http://www.aiswcd.org/wp-content/uploads/2013/06/IUM_June20131.pdf)

IDOT’s “Standard Specifications for Road and Bridge Construction” may also be used as a resource for erosion and sediment control design. Where this document conflicts with the Illinois Urban Manual, the Illinois Urban Manual should be used.



The “Standard Specifications for Road and Bridge Construction” can be accessed at the following link:

<http://idot.illinois.gov/doing-business/sales/manual-sales/index>

### General Requirements

Sediment control facilities are utilized to prevent sediment from leaving the site or entering buffers or special management areas within a development site. Sediment control structures commonly used may include sediment basins, sediment traps, and silt fences, among other practices. Sediment control facilities need to be in place for all drainage leaving the site prior to mass grading and need to remain in place for all phases of construction which are controlled by each practice. Plans for sediment control facilities should include grading or installation plan, sizing information, and maintenance procedures, including both during construction and during construction shutdown periods. Straw bale dikes are not preferred sediment control structures and should be used only where other alternatives are impractical.

### Extended Construction Shutdown Periods

The condition of the site for extended construction shut down periods (fourteen [14] days or greater) should be one of maximum stabilization and sediment trapping. Stabilization of areas wherever any clearing, grading, excavating, or other earth disturbing activities have temporarily (a minimum of fourteen days) or permanently ceased on any portion of the site needs to be stabilized (temporarily or permanently) immediately after each activity is complete.

Additionally, all of the site that will not be constructed prior to the fall planting season should be stabilized with appropriate vegetative cover. The fall planting season ends on approximately October 15<sup>th</sup>. Temporary seeding should be completed by this date. From October 1<sup>st</sup> until October 15<sup>th</sup>, heavy mulch should be applied with the seed to prevent seedling losses to early frost. Prior to October 1<sup>st</sup> standard mulching rates apply. In years with prolonged summer droughts, heavy mulching should be applied with all seeding. The use of erosion control blankets with seeding is preferred on slopes 3:1 or greater and that are more than 100 feet in length.

Areas that are to be worked after October 15<sup>th</sup> need to be stabilized with taciified heavy mulch or erosion control blankets. Areas where the stabilization is precluded by snow cover need to be stabilized as soon as practicable.

### Hydraulic and Hydrologic Design Requirements

Construction of sediment control structures is economically most practical when combined with stormwater management facilities. Because the site must have sediment control prior to mass grading, construction of the permanent

detention facility as a sediment stilling basin is preferred. The ordinance sets a minimum design standard for sediment basins and traps that is commensurate with the duration of the rainfall event and the size of the drainage area.

For all areas greater than 3-acres, the minimum storm frequency to be detained for sediment removal is as follows:

<b>Project Length</b>	<b>Design Event</b>	<b>Probability of Occurrence</b>
< 6 months	2 year	50%
6 months – 1 year	5 year	20%
> 1 year	10 year	10%

Sufficient volume needs to be created to retain all sediment from these design storm events. The facility needs to be sized to hold the required volume for a period not less than 10-hours. This is the minimum settling time necessary to remove a substantial volume of the sediment from the runoff. The discharge from the sedimentation basin must also not increase the pre-construction 2-year, 24-hour storm event runoff rate. Special consideration and sizing to avoid impacts to any of the following:

- Long or steep unvegetated slopes are present and will remain unstabilized for periods in excess of 7 days;
- The site drains into an adjacent Linear Watercourse, Non-linear Water body or wetland;
- The site drains into a previously developed parcel; and
- The site drains across public highway or off-site private road.

#### “As Needed” Practices on the Plans

“As needed practices” provide the permittee and the Administrator with a means to correct a deficiency in the management of erosion or in sediment control. Measures should be divided into temporary stabilization and sedimentation control measures. For each of these measures a typical detail should be provided. The project budget and contract should include each as well on a per unit basis.

#### Limitation on Site Disturbance

The limitation on site disturbance is in recognition of the need to prevent erosion in preference to controlling sediment. Site disturbances can not exceed 40 acres at any one time unless it is to balance cut and fill, for which an additional 40 acres may be disturbed at any one time (80 total acres). The Administrator has considerable flexibility to vary the maximum area of disturbance based on site or project specific conditions, or in recognition of a particularly effective plan with aggressive and effective implementation. The amount of area open to erosion at any one time poses a risk for delivery of

sediment downstream and the risk needs to be minimized consistent with the requirements of getting the project constructed.

The plan for limiting disturbance should be fully developed with both the applicant and the contractor. The plan may not be finalized until a permit is issued but must be finalized prior to construction. It should also be flexible to meet the challenges of Kane County weather patterns in the prime construction season.

Outside the normal spring and fall planting seasons, temporary stabilization may be accomplished by hydroseeding with heavy mulch. Multiple treatments may be necessary to adequately stabilize the site. The use of erosion control blankets with or without seed also meets the requirements.

Permanent stabilization requires the placement of seed and erosion control blankets or sod. In the case of dormant season seeding, the use of erosion control blankets with permanent seeding satisfies the requirement.

### Erosion and Sediment Control Plan Requirements

As part of the Stormwater Management Permit application submittal requirements, applicants are required to develop an erosion and sedimentation controls plan. As described in the Ordinance, the erosion and sedimentation control plans needs to include the following:

- 1) Detailed construction phasing plan identifying Erosion and Sedimentation Control Practices to be in place for each phase;
- 2) Erosion and Sedimentation Control Practices to be installed initially prior to stripping existing vegetation and/or mass grading;
- 3) The expected 2-year and 10-year Runoff rates from all off-site areas draining into the site;
- 4) Methods for temporary and permanent stabilization practices to be used to reduce velocity and Erosion from flow through the construction zone;
- 5) A maintenance schedule of each practice used, including elevations (or volumes) of sediment within each sedimentation basin at which point the sediment needs to be removed, including background calculations;
- 6) A note stating that "At a minimum, all Erosion and Sedimentation Control Practices on-site shall be inspected in accordance with the current IEPA NPDES ILR10 permit, which is weekly and after a one-half inch (1/2") or greater rainfall event, as of the Revision Date of Chapter 59 of the

Stormwater Management Ordinance. Any required repairs need to be made to keep these practices Functional as designed.”; and

## 7) Location of Special Management Areas

A maintenance schedule and weekly inspection worksheet should also be included. An inspection worksheet is provided in Part 2 of this manual. The inspection should evaluate stabilization as well as sediment control. Inspections should occur weekly and after 0.5 inch of rainfall or greater until permanent stabilization has been completely established. Weekly inspections may be reduced upon installation of permanent stabilization.

### Conveyance of Off-Site Flow

To the extent practicable, ditches and waterways that convey off-site flow through the site need to be permanently stabilized prior to accepting and conveying flood flows. The permanent stabilization should replace temporary measures, but it may be necessary to leave some temporary measures in place while the permanent stabilization establishes. Stabilization of off-site conveyance must protect the downstream land from erosion and sedimentation. Permanent stabilization must therefore include velocity reduction features at the property boundary. Use of level spreaders, lined aprons, and drop inlet pipe spillways are preferred.

### Erosion Control Blankets

Disturbed areas within a development that have a high erosion potential are required to be temporarily stabilized until the permanent stabilized practice is functional. Area requiring stabilization include areas devoid of vegetation, areas of moderate (5 horizontal to 1 vertical) or greater slopes, areas subject to flooding or stormwater runoff, or additional areas as determined by the Administrator. Erosion Control Blankets are utilized to temporarily stabilize areas until work commences in that area or vegetation has adequate opportunity to establish and become effective as a stabilization practice.

Erosion Control Blankets generally consist of biodegradable or photodegradable organic and/or synthetic materials. The longevity of the Erosion Control Blanket product selected should take into consideration the site conditions and required degree of stabilization. The mats shall degrade in place after the anticipated stabilization has become effective. The table below provides the categories of stabilization and the degradation requirements for each category:

Table T9-59 Erosion Control Blanket Degradation

<b>Stabilization Category</b>	<b>Stabilization Duration</b>	<b>Degradation Requirements</b>
Ultra Short-Term	3 Months	Net backing should begin to decompose after one (1) month and have 80% breakdown within three (3) months
Short-Term	12 Months	Net backing should be UV-stabilized to breakdown after one (1) full growing season
Extended Term	24 Months	Net backing should be UV-stabilized to breakdown after one (1) full growing season
Long-Term	36 Months	Net backing should be UV-stabilized to breakdown between twenty-four (24) and thirty-six (36) months

Stockpiles

Stockpiles and material storage are not to be placed in any special management areas or buffers unless approved by the Director or Administrator. When stockpiles remain in place for more than 3 days, temporary stabilization is required. An adequate distance should be kept between the stockpile and special management areas such that maintenance of stabilization can be performed without entry into the special management area.

Construction Dewatering

Discharge from site dewatering activities must be maintained in a manner that does not increase on-site erosion, convey sediment off-site, or cause off-site flood damages. Dewatering discharge may not outlet into wetlands on or off-site. Where practicable, discharge from on-site dewatering needs to be routed into the site sediment basin. Thus, sediment basin volume of storage should include site dewatering.

Protection of Public/Private Roadways

Public and private roadways must be kept free of nuisance soil. Access to the site must be large enough to provide a stabilized construction entrance of sufficient width and length, on-site parking, and vehicle washdown facility where appropriate. Soil tracked onto public right-of-way must be cleaned before the end of each workday. Street sweeping provides a mechanism for removal of loose soil materials but may not be sufficient to remove materials compacted onto the roadway surfaces. Removal of such compacted materials during each workday and when required by the Administrator is also required. Removal of



adhered soil materials will be done in a manner that does not damage the roadway or other right-of-way appurtenances.

### Temporary Stream Crossings

Temporary stream crossings of linear watercourses (for example, bridges, fords, and culvert crossings) should be designed for short-term use periods not to exceed 1 year. Temporary stream crossings are to be used only where there is no practicable alternative for moving heavy equipment from one side of a stream channel to another or where light duty equipment must cross a stream frequently for a very short period (<3 months).

Temporary stream crossings are applicable where the upstream drainage area does not exceed one square mile. For areas greater than one square mile, engineered structures should be designed. The following criteria should be addressed when designing temporary stream crossings:

- Erosion and sediment control
- Structural stability
- Safety
- Utility

At a minimum, the structure must be designed to pass the 2-year, 24-hour event and withstand erosion force of the 100-year (BFE) event. The outlet design velocity of the stream crossing structure should be non-erosive for the receiving stream. A swale or other water diversion needs to be constructed (across the roadway) on both approaches a maximum of 50 feet on either side of the crossing to prevent direct runoff to the stream.

### Pollution Prevention Plan

In addition to protection from sedimentation, the construction site and any offsite properties must be protected construction pollutants. The applicant is required to develop a pollution prevention plan for the site, which is typically included on the Erosion and Sediment Control Plans. The plans need to include specific pollution prevention practices, locations where each practice is proposed to be utilized, specifications for installation, and specifications for inspection and maintenance. The SMO includes examples of pollution prevention strategies.

## ARTICLE IV – REQUIREMENTS FOR STORMWATER MANAGEMENT

### § T9-81 General Information

This manual provides guidance for the interpretation of the requirements established in the Ordinance. In order to determine if a development requires a Kane County Stormwater Management permit, the applicant should refer to Section 9-81 Table 9-81 of the Ordinance. Table 9-81 assists the developer/applicant in determining which components of the stormwater permit submittal will be required. For activities exempt from the Ordinance, the applicant is referred to Section 9-81.B.3.

#### Thresholds

Table 9-81 of the Ordinance has been provided on the following page. Examples for each row of the table and are provided on the pages following the Table T9-81.

Table T9-81

<b>Development Category</b>	<b>New Impervious Area for Development or Net New Impervious Area for Redevelopment</b>	<b>Detention Storage Facility (Section)</b>	<b>Stormwater Mitigation / BMP (Section)</b>	<b>Watershed Benefit Measure<sup>1</sup> (Section)</b>	<b>Fee-in-Lieu<sup>3</sup> (Section)</b>
Development or Redevelopment	< 5,000 sq.ft. <b>See Examples T9-81.A.1.a &amp; T9-81.A.1.b</b>		X <sup>2</sup> (9-107.C)		A (9-85)
	5,000 sq.ft. – 24,999 sq.ft. <b>See Examples T9-81.A.2 &amp; T9-81.A.2.b</b>		X (9-107.C)		A (9-85)
	≥ 25,000 sq.ft. AND < 1% Site area <b>See Example T9-81.A.3</b>	X (9-84)	X (9-107.D)	O (9-108)	A (9-85)
	≥ 25,000 sq.ft. AND ≥ 1% Site area <b>See Examples T9-81.A.4.a &amp; 9-81.A.4.b</b>	X (9-84)	X (9-107.D)		A (9-85)
Linear Project (Trails/Roads)	> 1-acre in aggregate for roads and trails that are ≤ AASHTO max. width <b>See Example T9-81.A.5</b>		X <sup>1</sup> (9-107.C)	O (9-108)	A (9-85)
	> 1-acre in aggregate for roads and trails that are > AASHTO max. width <b>See Example T9-81.A.6</b>	X (9-84)	X (9-107.D)		A (9-85)
Total Impervious Area > 50% Site area (for Sites < 1-acre) <b>See Example T9-81.A.7</b>			X (9-107.C)		A (9-85)
Hydrologically Disturbed Area > 3-acres <b>See Examples T9-81.A.8 and T9-81.A.4.b</b>		X <sup>4</sup> (9-84)	X (9-107.D)	O (9-108)	A (9-85)
X = Required; O = Option for required measure; A = Allowed					

<sup>1</sup>A **Watershed Benefit Measure** may be provided in lieu of the required **Detention Storage Facility** and **Stormwater Mitigation/BMP** at the discretion of the **Administrator**.

<sup>2</sup> Required at the discretion of the **Administrator** where known flooding or drainage issues are in the immediate vicinity of the project, in areas without **Adequate Downstream Stormwater Capacity**, or that outlet to a **Volume Sensitive Watershed**.

<sup>3</sup>Fee-in-lieu requires approval of the **Administrator** and compliance with the requirements listed under Subsection 9-81.B.4 of this Section.

<sup>4</sup>**Redevelopment** with a **Net New Impervious Area** less than the **Impervious Area** being removed will not be required to provide a **Detention Storage Facility** per Section 9-81.B.3.a.

*Example T9-81.A.1.a*



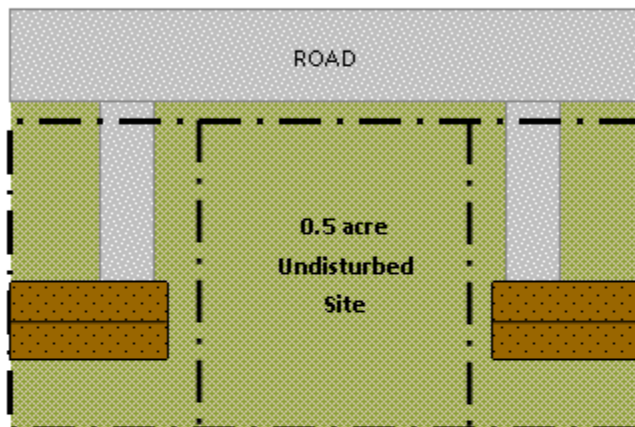

Development of an undisturbed 0.5 acre (21,780 sq. ft.) Site is proposed with a 3,500 sq. ft. house and 1,000 sq. ft. driveway with a total of 4,500 sq. ft. of New Impervious Area. No known drainage issues are in the immediate vicinity of the project.

Existing Site:

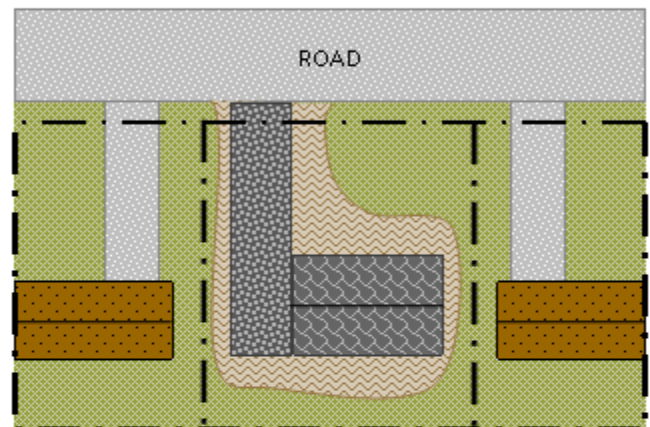

Proposed Site:



-  Existing Undisturbed (not a Hydrologically Disturbed Area) = 0.5 acre (21,780 sq. ft.)
-  Existing Impervious = 0 sq. ft.
-  Proposed Pervious (Hydrologically Disturbed Area) = 0.25 acre
-  New Impervious Area (Hydrologically Disturbed Area) = 4,500 sq. ft

Total Impervious Area =  $4,500 / 21,780 = 0.20 * 100 = 20\%$  of Site area

Detention Required = No, < 25,000 sq. ft. New Impervious Area

Stormwater Mitigation/BMP = No, < 5,000 sq. ft New Impervious Area

No, < 50% Total Impervious Area on Site < 1 acre

*Example T9-81.A.1.b*



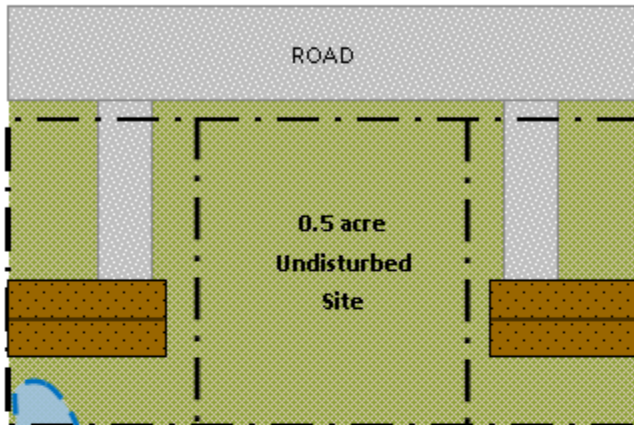

Development of an undisturbed 0.5 acre (21,780 sq. ft.) Site is proposed with a 3,500 sq. ft. house and 1,000 sq. ft. driveway with a total of 4,500 sq. ft. of New Impervious Area. Drainage issues are in the immediate vicinity of the project.

Existing Site:

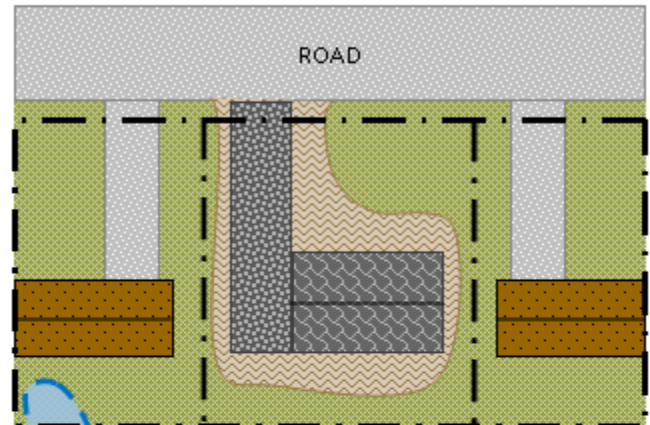

Proposed Site:



-  Existing Undisturbed (not a Hydrologically Disturbed Area) = 0.5 acre (21,780 sq. ft.)
-  Existing Impervious = 0 sq. ft.
-  Proposed Pervious (Hydrologically Disturbed Area) = 0.25 acre
-  New Impervious Area (Hydrologically Disturbed Area) = 4,500 sq. ft.
-  Poor Drainage Area

Total Impervious Area =  $4,500 / 21,780 = 0.20 * 100 = 20\%$  of Site area  
 Detention Required = No, <25,000 sq. ft. New Impervious Area  
 Stormwater Mitigation/BMP = No, less than 5,000 sq. ft. of New Impervious Area  
 No, < 50% Total Impervious Area on Site < 1 acre  
 Yes<sup>2</sup>, drainage issue is in the immediate vicinity of the project.

<sup>2</sup> Required at the discretion of the **Administrator** where known flooding or drainage issues are in the immediate vicinity of the project, in areas without **Adequate Downstream Stormwater Capacity**, or that outlet to a **Volume Sensitive Watershed**.



*Example T9-81.A.2.a:*



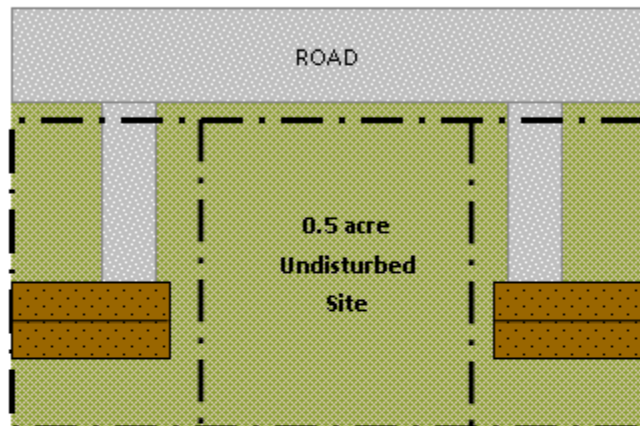

Development of an undisturbed 0.5 acre (21,780 sq. ft.) Single Family Residential Site is proposed with a 5,000 sq. ft. home and 3,500 sq. ft. driveway/patio with a total of 8,500 sq. ft. of proposed New Impervious Area.

Existing Site:

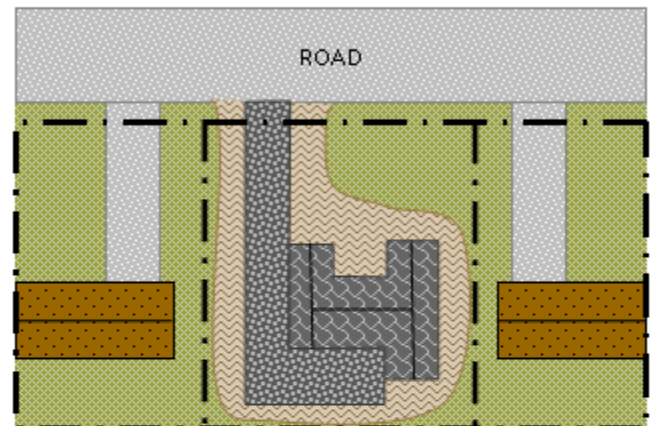

Proposed Site:



-  Existing Undisturbed (not a Hydrologically Disturbed Area) = 0.5 acre (21,780 sq. ft.)
-  Existing Impervious = 0 sq. ft.
-  Proposed Pervious (Hydrologically Disturbed Area) = 0.25 acre
-  New Impervious Area (Hydrologically Disturbed Area) = 8,500 sq. ft.

Total Impervious Area =  $8,500 / 21,780 = 0.39 * 100 = 39\%$  of Site area

Detention Required = No, < 25,000 sq. ft. New Impervious Area

Stormwater Mitigation/BMP = Yes, New Impervious Area > 5,000 sq. ft.

Example T9-81.A.2.b

Redevelopment of a 0.5 acre (21,780 sq. ft.) Site is proposed with a 4,000 sq. ft. house and 2,500 sq. ft. driveway, patio & detached garage with a total of 5,000 sq. ft. of Net New Impervious Area. No known drainage issues are in the immediate vicinity of the project.

Existing Site:

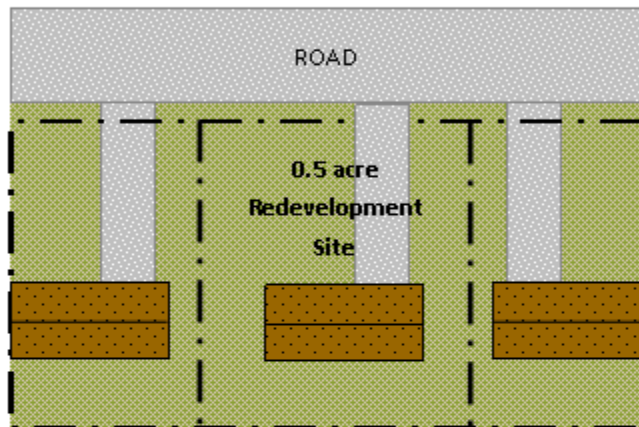

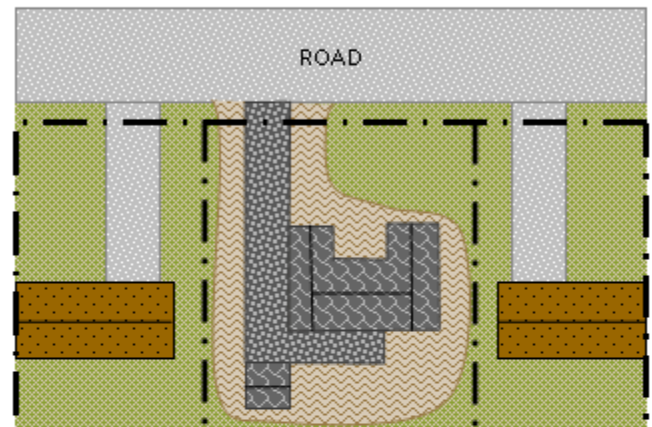

Proposed Site:



 Existing Undisturbed (not a Hydrologically Disturbed Area) = 0.5 acre (21,780 sq. ft.)

 Existing Impervious = 1,500 sq. ft.

 Proposed Pervious (Hydrologically Disturbed Area) = 0.25 acre

 New Impervious Area (Hydrologically Disturbed Area) = 6,500 sq. ft.

Net New Impervious Area (Hydrologically Disturbed) =

(New Impervious Area - Existing Impervious Area Removed)

$6,500 - 1,500 = 5,000$  sq. ft.

Total Impervious Area =  $6,500 / 21,780 = 0.30 * 100 = 30\%$  of Site area

Detention Required = No, < 25,000 sq. ft. Net New Impervious Area

Stormwater Mitigation/BMP = Yes, 5,000 sq. ft. Net New Impervious Area

### Example T9-81.A.3



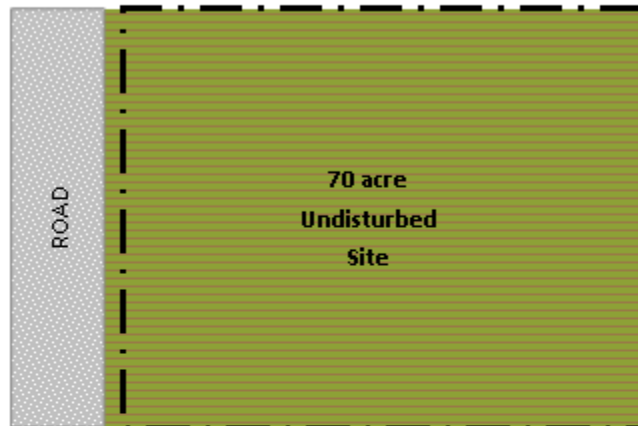

Development of an undisturbed 70 acre agricultural Site with a 25,500 sq. ft. pole barn/driveway with 0.6 acre of Hydrologically Disturbed Area.

#### Existing Site:

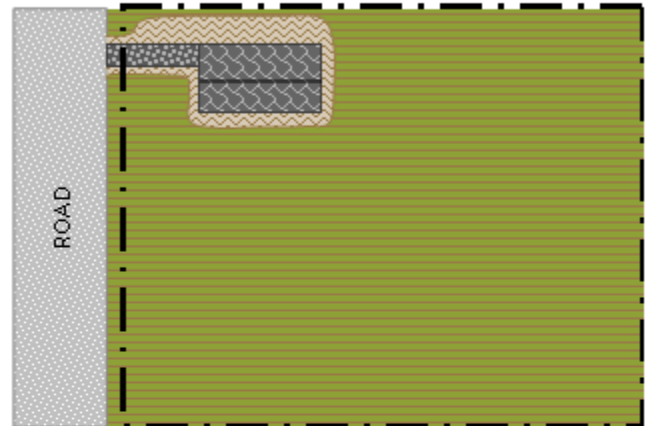

#### Proposed Site:



-  Existing Undisturbed (not a Hydrologically Disturbed Area) = 70 acres
-  Existing Impervious = 0 sq. ft.
-  Proposed Pervious (Hydrologically Disturbed Area) = 0.25 acre (21,780 sq. ft.)
-  New Impervious Area (Hydrologically Disturbed Area) = 0.58 acre (25,500 sq. ft)

Total Impervious Area =  $0.57 / 70 = 0.008 * 100 = 0.8\%$  of Site area

Detention Required = Yes<sup>1</sup>, > 25,000 sq. ft. New Impervious Area but less than 1% of the Site area

Stormwater Mitigation/BMP = Yes<sup>1</sup>, New Impervious Area > 5,000 sq. ft. and greater than 1% of the Site area

<sup>1</sup>A **Watershed Benefit Measure** may be provided in lieu of the required **Detention Storage Facility** and **Stormwater Mitigation/BMP** at the discretion of the **Administrator**.

*Example 9-81.A.4.a*



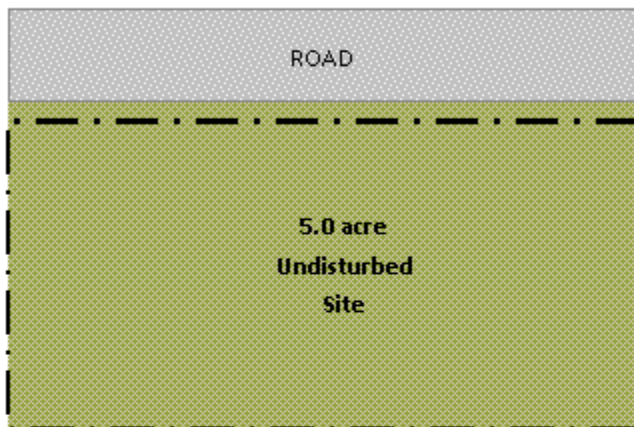

Development of an undisturbed 5 acre Site is proposed with a commercial warehouse and a parking lot resulting in 2 acres of New Impervious Area and 1 acre of pervious Hydrologically Disturbed Area.

Existing Site:

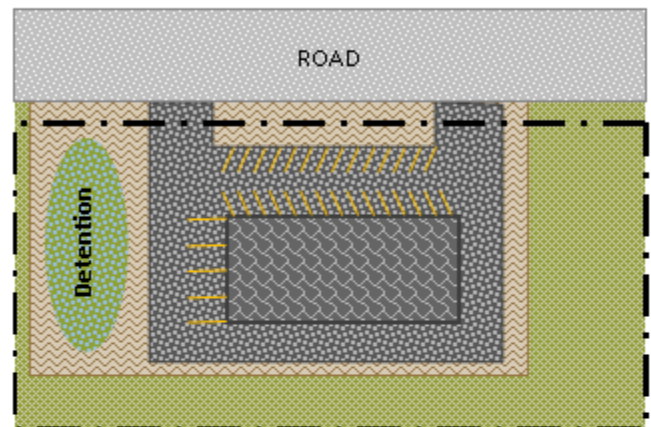

Proposed Site:



-  Existing Undisturbed (not a Hydrologically Disturbed Area) = 5.0 acres
-  Existing Impervious = 0 sq. ft.
-  Proposed Pervious (Hydrologically Disturbed Area) = 1.0 acre
-  New Impervious Area (Hydrologically Disturbed Area) = 2.0 acres

Total Impervious Area =  $2 / 5 = 0.4 * 100 = 40\%$  of Site area

Detention Required = Yes > 25,000 sq. ft. New Impervious Area and greater than 1% of the Site area

Stormwater Mitigation/BMP = Yes, New Impervious Area > 5,000 sq. ft. and greater than 1% of the Site area

*Example 9-81.A.4.b*

Redevelopment of a 5 acre Site is proposed. An existing 3 acre parking lot will be removed and replaced with a new building and parking lot resulting in 2 acres of New impervious Area. 1 acre of existing Impervious Area will be removed. The entire Site will be regraded and is a Hydrologically Disturbed Area.

Existing Site:

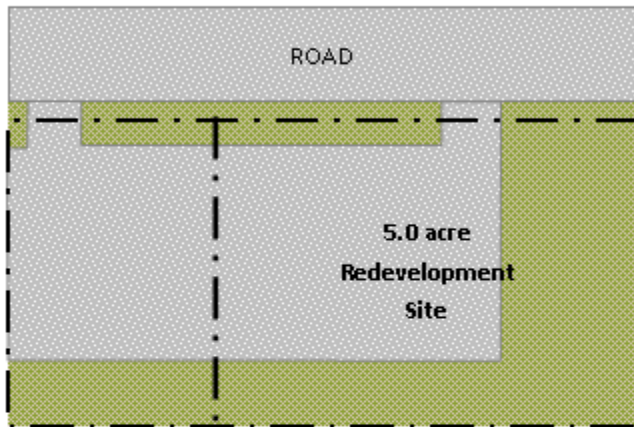

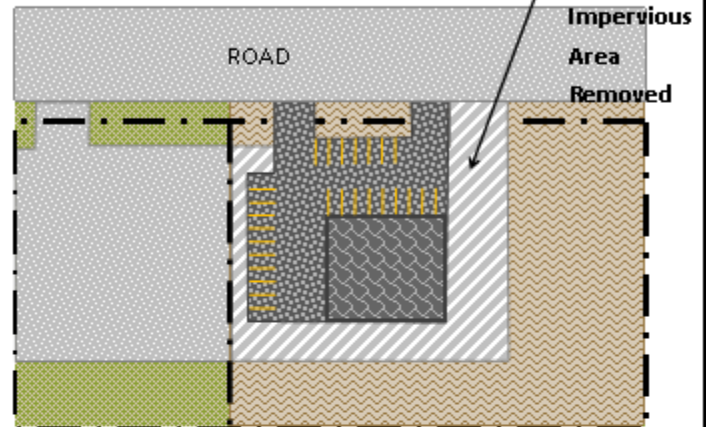

Proposed Site:



 Existing Undisturbed (not a Hydrologically Disturbed Area) = 2.0 acres

 Existing Impervious = 3.0 acres

 Proposed Pervious (Hydrologically Disturbed Area) = 2.0 acre

 Net New Impervious Area (Hydrologically Disturbed) =  
 (New Impervious Area - Existing Impervious Area Removed)  
 $2.0 - 3.0 = -1.0$  acre

Total Impervious Area =  $2 / 5 = 0.4 * 100 = 40\%$  of Site area

Detention Required = No<sup>4</sup>, Net New Impervious Area < 25,000 sq. ft.

No<sup>4</sup>, Hydrologically Disturbed area > 3 acres, however meets the exemption under 9-81.B.3.a as the Net New Impervious Area is less than the Impervious Area being removed.

Stormwater Mitigation/BMP = Yes, Hydrologically Disturbed Area > 3 acres

<sup>4</sup>**Redevelopment** with a **Net New Impervious Area** less than the **Impervious Area** being removed will not be required to provide a **Detention Storage Facility** per Section 9-81.B.3.a.



*Example 9-81.A.5*



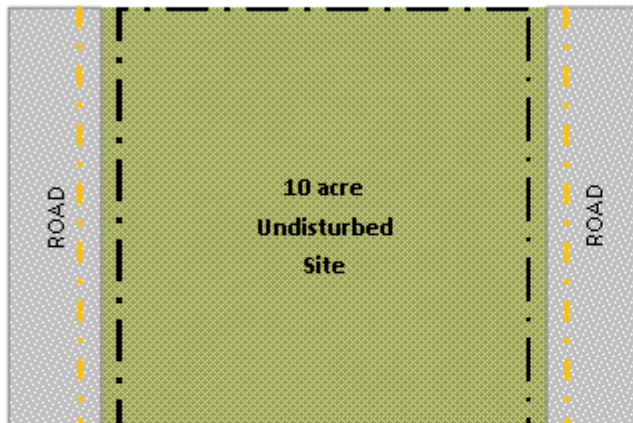

Development of an undisturbed 10 acre Site is proposed with a 3,200 linear foot 14' wide mixed use trail by a Park District to connect two on-road bike lanes. The linear project results in greater than 1-acre New Impervious Area in aggregate bike trail less than the AASHTO maximum width for its designated use.

Existing Site:

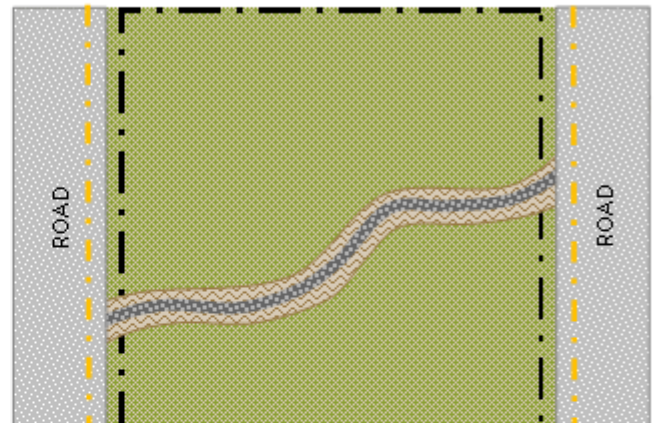

Proposed Site:



-  Existing Undisturbed (not a Hydrologically Disturbed Area) = 10.0 acres
-  Existing Impervious = 0 sq. ft.
-  Proposed Pervious (Hydrologically Disturbed Area) = 1.5 acre
-  New Impervious Area (Hydrologically Disturbed Area) = 1.03 acres (44,800 sq. ft.)

Total Impervious Area = N/A

Detention Required = No, trail width is below the AASHTO maximum width for mixed use trails

Stormwater Mitigation/BMP = Yes<sup>1</sup>, New Impervious Area > 1 acre aggregate

<sup>1</sup>A **Watershed Benefit Measure** may be provided in lieu of the required **Detention Storage Facility** and **Stormwater Mitigation/BMP** at the discretion of the **Administrator**.

*Example 9-81.A.6*



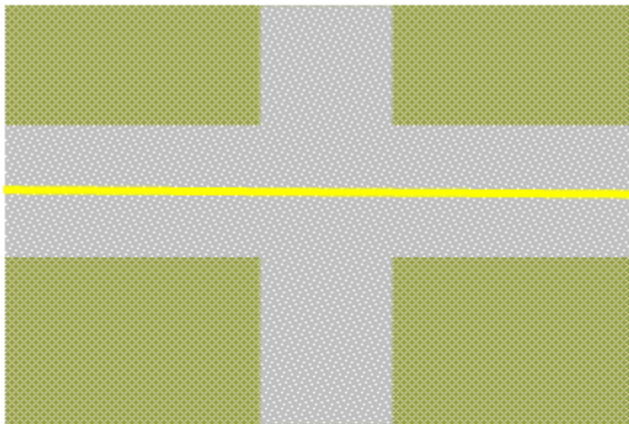

An existing public roadway is being widened to accommodate a 3,630 linear foot middle turn lane and shoulder widening that exceed the maximum width for the designated use. The New Impervious Area exceeds 1 acre in aggregate.

Existing Site:

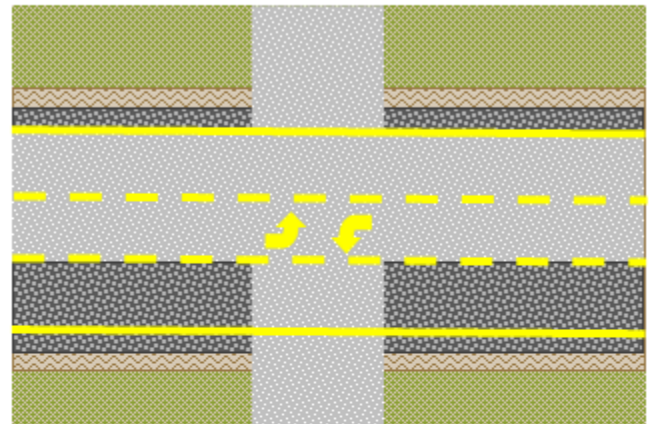

Proposed Site:



-  Existing Undisturbed (not a Hydrologically Disturbed Area) = 3.0 acres
-  Existing Impervious = 2.0 acres (87,120 sq. ft.)
-  Proposed Pervious (Hydrologically Disturbed Area) = 0.5 acre
-  New Impervious Area (Hydrologically Disturbed Area) = 1.5 acres (65,340sq. ft.)

Total Impervious Area = N/A  
 Detention Required = Yes, Net New Impervious Area > 1 acre in aggregate  
 Stormwater Mitigation/BMP = Yes, Net New Impervious Area > 1 acre in aggregate

### Example 9-81.A.7

Redevelopment of a 0.9 acre (39,204 sq. ft.) Site is proposed. The Site has an existing 8,500 sq. ft. small office building and parking lot. The building will be demolished and rebuilt in the same location with an additional 3,350 sq. ft. footprint within an area that is currently undisturbed pervious.

Existing Site:

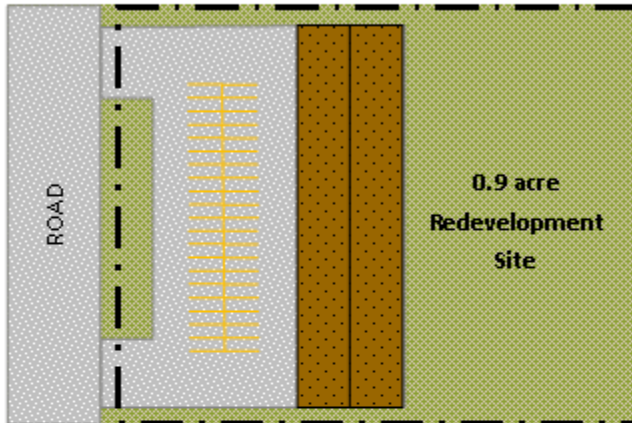

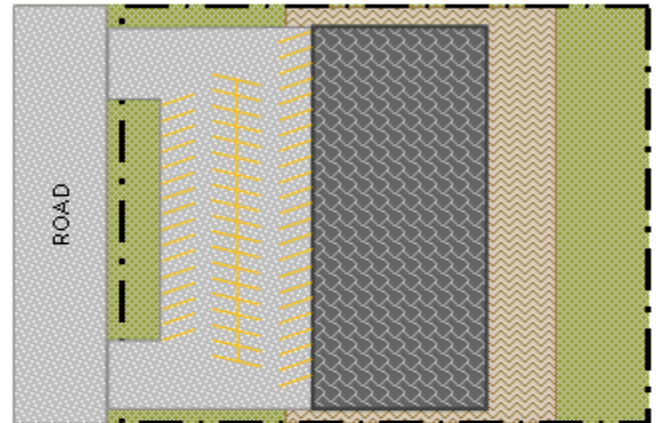

Proposed Site:



 Existing Undisturbed (not a Hydrologically Disturbed Area) = 0.5 acre (21,780 sq. ft.)

 Existing Impervious = 0.4 acre (17,424 sq. ft.)

 Proposed Pervious (Hydrologically Disturbed Area) = 0.2 acre

 New Impervious Area (Hydrologically Disturbed Area) = 11,850 sq. ft.

 Net New Impervious Area (Hydrologically Disturbed) =  
 (New Impervious Area - Existing Impervious Area Removed)  
 20,778 - 17,424 = 3,350 sq. ft.

Total Impervious Area =  $20,778 / 39,204 = 0.52 * 100 = 52\%$  of Site area

Detention Required = No, <25,000 sq. ft. New Impervious Area

Stormwater Mitigation/BMP = No, Net New Impervious area < 5,000 sq. ft.

Yes, Total Impervious Area is > 50% of the Site for Sites < 1 acre

Example 9-81.A.8



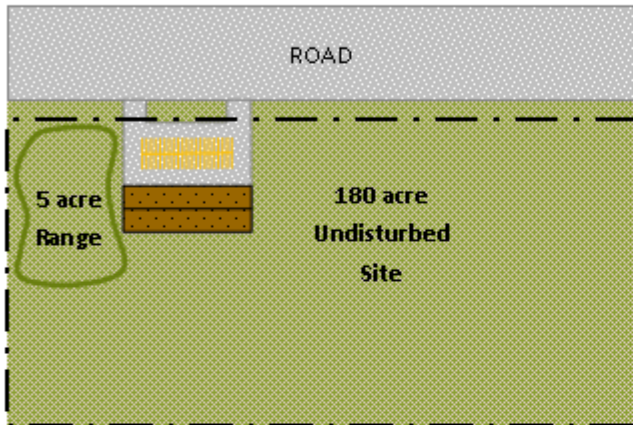

A 180 acre golf course is proposing to re-grade its 9 acre driving range and practice area. The regraded areas will remain pervious.

Existing Site:

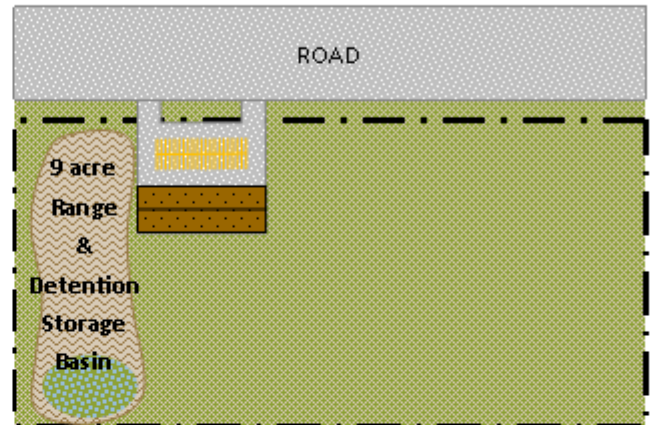

Proposed Site:



-  Existing Undisturbed (not a Hydrologically Disturbed Area) = 180.0 acres
-  Existing Impervious = 25,000 sq. ft.
-  Proposed Pervious (Hydrologically Disturbed Area) = 9.0 acre
-  New Impervious Area (Hydrologically Disturbed Area) = 0 acres

Total Impervious Area =  $0 / 180 = 0.0 * 100 = 0\%$  of Site area

Detention Required = Yes<sup>1</sup>, Hydrologically Disturbed Area > 3 acres

Stormwater Mitigation/BMP = Yes<sup>1</sup>, Hydrologically Disturbed Area > 3 acres

<sup>1</sup>A **Watershed Benefit Measure** may be provided in lieu of the required **Detention Storage Facility** and **Stormwater Mitigation/BMP** at the discretion of the **Administrator**.

## § T9-82 General Stormwater Requirements

Stormwater drainage requirements are applied to all development and redevelopment throughout Kane County to prevent inappropriate site drainage contributing to increased flood damage. Proper site drainage analysis is meant to protect existing and future structures, as well as sub-surface infrastructure. The developer must consider possible adverse effects of the proposed activity and avoid knowingly undertaking any activity that will cause a violation of the general Standards specified in the Ordinance.

## § T9-83 Site Runoff Requirements

### Stormwater Systems

Major stormwater system drainageways are flow paths used only during major storms when the minor systems are overloaded. Restricting major stormwater flows to drainageways reduces the potential for flood damage.

Stormwater Systems through the property that convey flows from areas off the development site should be left undisturbed or sized in accordance with the guidance set forth below.

Design of the stormwater systems may require:

1. Calculation of runoff rates for both the minor system condition and the major system condition;
2. Designing culverts, swales, catch basins and other “minor” drains to convey the minor design event fully; and
3. Calculating overland flow paths (broad swales, roadways, etc.) sufficient to carry the major design event flows and verifying that these flow paths do not result in property damage.

### Drainageways

1. All drainageways should be designed for open-channel flow conditions. Surcharged design is acceptable only where the designer has fully considered the potential for hydrodynamic transients and the impacts on all connected drainageways. For minor stormwater systems that do not use open-channels, the drainageways may be calculated using the Modified Rational Method for sites less than 20-acres.

2. Stormwater system hydraulic grade lines (water surface elevation plus the pressure head) shall be below elevations that could potentially cause damage. Hydraulic grade line evaluations must proceed upstream from:
  - a) A demonstrated free overflow; or
  - b) The expected base flood elevation of the most downstream point analyzed; or
  - c) An alternative assumption demonstrated to be appropriate and conservative.

Steady-state backwater calculations are appropriate for calculating hydraulic grade lines in low-impact systems remote from the floodplain. Such calculations must consider at least the pressure and velocity heads of all drainageways. Tools that may be appropriate to assist in calculations include spreadsheets HEC-RAS and, FHWA's HYDRA and Hydraflow.

3. Employ flood routing techniques for hydraulic evaluations for drainageways downstream of storage systems that address the time-varying nature of the storage facility adequately. If all storage basins are off-line or not in sequence, time-varying hydraulic routing need not be considered. Include the maximum discharge rated from the storage facility in the flow estimate at all downstream points.

For in-line or sequential basins, the routing downstream must consider explicitly, or estimate conservatively, the impact of sequential storms, alternative storm patterns, and routing impacts between storage facilities. Continuous hydrologic routing techniques provide the explicit treatment of these factors. Such routing can be accomplished manually or by using appropriate time-varying hydraulic programs (e.g., STORM, SWMM, FEQ, UNET, HSPF).

4. Control maximum drainage system velocities in flow over roadways to address public safety needs. A commonly applied guide is that the product of velocity (ft./sec.) and depth (ft.) should not exceed a value of 4 for the storm with a 0.01 probability of occurrence in any year. Section 9-83 I. defines the maximum allowable flow depths for transverse stream crossings of roads.
5. Sufficient energy dissipation should be provided at the outlet to prevent scouring of the streambank, bed, or downstream land. Armoring of the stream channel should not be considered in lieu of energy dissipation. Energy dissipation is essential to avoid transferring scour and stability problems further downstream.

6. To the extent possible, open-channel drainageways should have permanently deep-rooted vegetated side slopes and inverts with velocities sufficiently limited to prevent scouring. This guide addresses the Plan requirement to control sediment and erosion from drainageways.
7. Design reasonable side slopes given the engineering properties of the materials. A 3:1 side slope typically provides adequate stability in an earth channel and is a mowable slope. A 4:1 or shallower side slope is desirable. Deviations from the minimum value should be justified by appropriate calculations (e.g., slope stability calculations) and maintenance plans that do not require mowing.

### Overland Flow Path Design

Overland flow paths are to be designed to safely convey the 1% annual chance flood event. The design of an overland flow path needs to account for the lowest opening of adjacent structures. For sites with the tributary area greater than 20 acres, the lowest entry elevation opening needs to be at least 2 feet above the design water surface elevation of the overland flow route. The design flow rate for overland flow routes should be a minimum of 1 cfs per tributary acre. For sites with less than 20 acres of tributary area, 0.50 feet of freeboard is required.

The overland flow paths can be sized using Manning's equation:

$$Q = \left( \frac{1.49}{n} \right) AR^{2/3} S^{1/2}$$

*Where:*

*n* is the channel roughness coefficient. This can be determined based upon Table 3-1 from the US Army Corps of Engineers: Hydrologic Engineering Center. by Gary W. Brunner. *HEC-RAS, River Analysis System Hydraulic Reference Manual*. CPD-69. Davis, CA: 2016, <https://www.hec.usace.army.mil/software/hec-ras/documentation/HEC-RAS%205.0%20Reference%20Manual.pdf>

A is the cross-sectional area  
P is the wetted perimeter; and  
R is the hydraulic radius.

**FIGURE T9-83.A**  
**Geometric Elements of Channel Sections**  
 (Reference: Chow, Ven Te, 1959; Open-Channel Hydraulics)

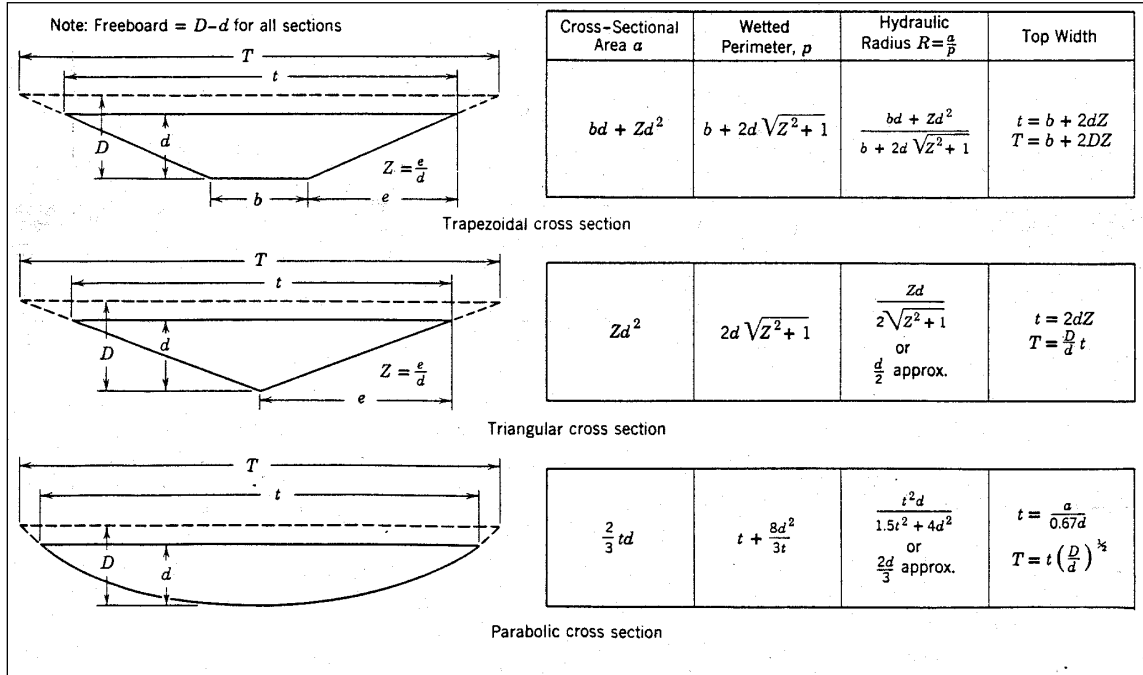

Existing Sub-Surface Drainage Systems

The applicant must locate all existing field tile systems on the project site according to Section 9-83 B. of the Ordinance. Particular attention should be paid to those field tile systems that are used to convey off-site flow through the site to a downstream location. It is the responsibility of the developer to maintain adequate capacity of off-site drain tile systems entering the site. The ordinance requires the preparation of a detailed subsurface drainage survey outlined in Section 9-83.B.2. The Standard County notes need to be incorporated onto the subsurface drainage survey. The following notes are to be considered a minimum standard. The person conducting the subsurface drainage survey may need to include additional notes according to the site conditions.

County Notes:

ALL EXISTING AGRICULTURAL DRAIN TILES LOCATED DURING THIS SUBSURFACE DRAINAGE SURVEY HAVE BEEN IDENTIFIED ON THIS PLAN AND FIELD STAKED AT < 50' INTERVALS.

ALL EXISTING DRAIN TILES DAMAGED DURING THE INVESTIGATION PROCESS SHALL BE REPAIRED TO THEIR ORIGINAL STATE IN ACCORDANCE WITH NATURAL RESOURCE CONSERVATION SERVICE STANDARDS FOR DRAIN TILE INSTALLATION AND REPAIR



THIS SUBSURFACE DRAINAGE SURVEY REPORT IS INTENDED TO IDENTIFY EXISTING DRAIN TILE MAINLINE SYSTEMS WITH ADDITIONAL PRIORITY ON DRAIN TILES WHICH MAY SERVICE THE UPLAND PROPERTY OF OTHERS OR WITH MUTUAL DRAINAGE STATUS

THIS SUBSURFACE DRAINAGE SURVEY WAS PREPARED IN ACCORDANCE WITH THE KANE COUNTY STORMWATER MANAGEMENT ORDINANCE AND DRAIN TILE INVESTIGATION STANDARDS.

A sample scope of work is provided below to aid in the development of performing a subsurface drainage survey:

Sample Scope of Work:

- Field reconnaissance and record research work shall be performed in efforts to identify all areas which are typical to installation of existing drain tile.
- Existing features such as soils, water table, topographical elevations, surface channels, depressions, wetlands and natural drainage ingress and egress locations shall be documented.
- Investigation areas shall be staked and slit trenched to verify existence of drain tile.
- All existing drain tiles encountered during the investigation procedure shall be logged on field mapping and repaired to their original state according to U.S.D.A. Natural Resource Conservation Service construction repair practices.
- Drain tile routes shall be located by surface probing or electronic detection and field staked at <20' intervals including cut stakes for invert elevations
- All existing drain tile routes shall be located in the field by GPS location systems (<1m., *Illinois State Plane East NAD 83*) and recorded on final plans.
- Mapped information shall include the location of all existing drain tile routes and applicable drainage findings encountered during the field investigation process.
- A field report shall be attached to the plan containing evaluation information including size, flow, system effectiveness, restrictive siltation, pipe invert to ground surface depth, pipe type / quality, system classification and specific field notes.
- After completion of the investigation report, final existing drain tile investigation mapping and report approval and acceptance shall be obtained by County Planning and Development technical staff and applicable engineering review agencies.

## Outfall into Agricultural Surface Drainage Systems and Steep Slope Zones

Extended discharge from Detention Storage Facilities of surface water drainage over cropped fields and steep ravines can create conditions that can damage agricultural crops and cause severe erosion in ravines due to extended saturation of soils. Therefore, the ordinance requires underground conveyance of surface water discharge systems within forty-eight (48) hours of the end of a storm event. Additional guidance for Steep Slopes zones is included in the Forms. In general, Steep Slope is defined as land with a slope which equals or exceeds a vertical rise of one foot for a horizontal run of three feet for a vertical height of 10 feet or more. Many of the Steep Slope zones in Kane County fall in the Ferson Creek watershed such as the example below in Campton Township:

Figure T9-83.B Example Steep Slope Zone

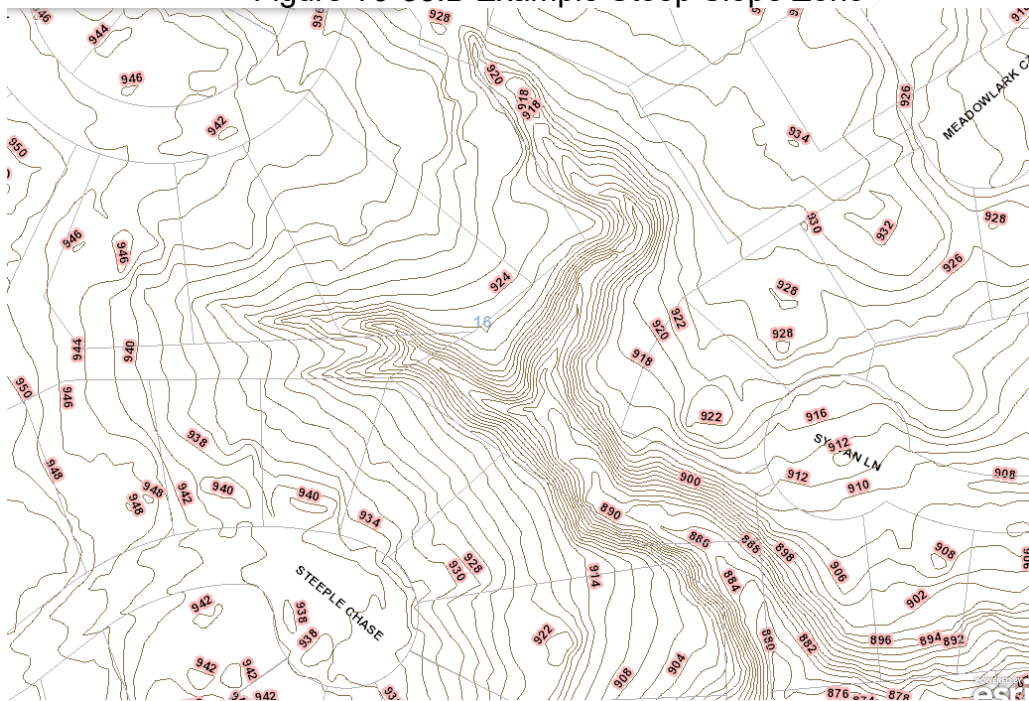

Agricultural surface drainage systems are defined as upland cropped or grassed waterways that experience intermittent stormwater flows during storm events. These systems do not convey groundwater or agricultural subsurface drainage outfalls and are not considered to be an adequate outfall for extended releases from Detention Storage Facilities or Nuisance Flow. Below are two examples of Agricultural surface drainage systems in which the 48 hr requirement would apply:

Figure T9-83.C Grassed Waterway



Figure T9-83.D Soy Bean Crop During Rain Event

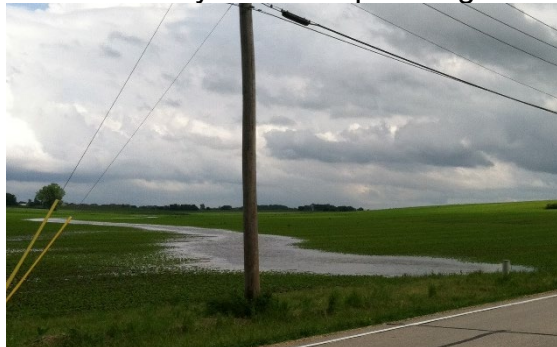

An example of sizing for a forty-eight (48) hour system for a Development is provided on the following pages.

**Example T9-83.A:**

A residential development is proposed on a 26.1 acre site with 100 parcels and 40% impervious Area.

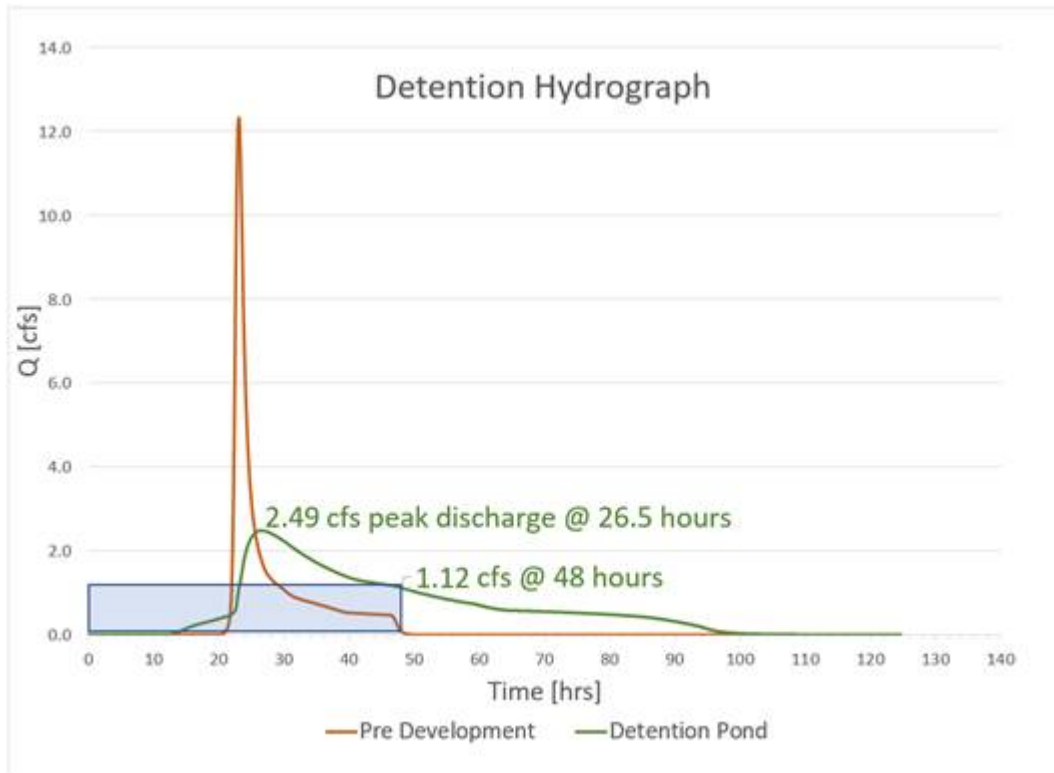

Step 1: Utilize the proposed hydrograph to determine the flow at 48 hours. In the example above, the flow is 1.12 cfs.

Step 2: Determine sump pump flows at 5 gpm per first 50 Single Family Residential (SFR) structures and 3 gpm for each structure after if basements are expected to be in seasonal high groundwater table:

$$(5gpm \times 50SFR) + (3gpm \times 50SFR) = 400gpm = 0.89cfs$$

Step 3: Determine Stormwater Mitigation/BMP volume and underdrain flow per Section 9-107.D.1

$$V_{BMP} = 1in \times NI_{HDA}$$

$$1in \times \frac{1ft}{12in} \times 454,766ft^2 = 37,745ft^3$$

$$37,745ft^3 \div 259,200 = 0.146cfs$$

Where:

$$New\ Impervious\ Area\ (NI_{HDA}) = 26.1ac \times \frac{43,560ft}{1ac} = 454,766ft^2$$

Draw down time of the BMP is 3 days

$$3days \times (86,400\ sec/day) = 259,200sec$$

Step 4: Sum flow rates and size pipe:

$$1.12cfs + 0.89cfs + 0.146cfs = 2.156cfs$$

Therefore, the off-site subsurface outfall should be sized for 2.16 cfs. Assuming the slope is 0.2% the required pipe size using Figure T9-83.E should be 15”.

The ordinance does not allow for the connection of surface or nuisance water discharges into Agricultural subsurface drainage systems unless a signed and recorded written agreement between the Applicant and the downstream owner is established. The ordinance does allow for discharge of underdrains from Stormwater Mitigation/BMP into an agricultural subsurface drainage system so long as the discharge does not exceed the capacity discussed below.

The potential for use of an existing agricultural subsurface drainage system for Stormwater Mitigation/BMP underdrain discharge can be determined by checking the topography tributary area upstream of a development which contains hydric soil and multiplying by 0.003 cfs/acre. If a drain tile system outlets into an adjacent property's drain tile system, the downstream drain tile capacity must be calculated using the slope and size of the drain tile. If the developer is not able to determine the capacity of the downstream system, then the assumption for the capacity should be limited to 0.003 cfs/acre multiplied by the amount of acres on the developer's property of hydric soil tributary to the point where it exits the developer's property. This capacity can then be compared to the proposed Stormwater Mitigation/BMP tributary drainage area to determine if sufficient capacity exists to serve the underdrain system.

All field tile systems within the development that do not serve a particular benefit (i.e., draining open space) should be removed. Furthermore, the concentration and conveyance of infiltrated runoff may cause problems from partial tile systems left in place. Partial tile systems not serving a purpose should be removed. Any on-site field tiles which remain on-site should be identified in record drawings.

Subsurface connections serving off-site Tributary Areas upstream of the development need to be sized based upon a drainage coefficient of 3/8" per day, slope and the upstream tributary area served by the subsurface system using the following figure:

Figure T9-83.E  
 Design Chart for Plastic Tubing Using a Drainage Coefficient of  $3/8$  in/day

INSERT Reference

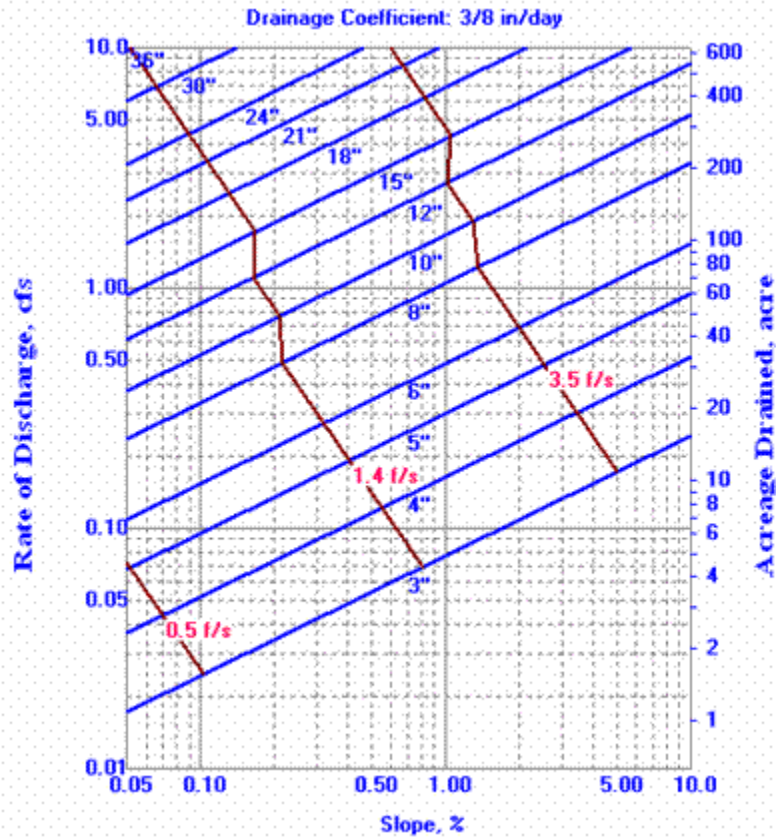

Note: Fractions of equivalent pipe diameter should be rounded to typical pipe sizes according to the following divisions:

$0" < D_{eq} \leq 3.5"$	=	3" tile
$3.5" < D_{eq} \leq 4.5"$	=	4" tile
$4.5" < D_{eq} \leq 5.5"$	=	5" tile
$5.5" < D_{eq} \leq 6.5"$	=	6" tile
$6.5" < D_{eq} \leq 8.5"$	=	8" tile
$8.5" < D_{eq} \leq 10.5"$	=	10" tile
$10.5" < D_{eq} \leq 12.5"$	=	12" tile
$12.5" < D_{eq} \leq 15.5"$	=	15" tile
$15.5" < D_{eq} \leq 18.5"$	=	18" tile
$18.5" < D_{eq} \leq 21.5"$	=	21" tile
$21.5" < D_{eq} \leq 24.5"$	=	18" tile

### Downstream Water Surface Elevations

Outfalls are hydraulic structures whose capacity is governed by a balance between upstream and downstream head. Outfall capacity is calculated within

the range of differences in upstream and downstream hydraulic grade line that can be expected to occur statistically for a 100-year return period. It is important to make realistic assumptions about the outfall capacity.

Calculations should assume free outfall conditions only if hydraulic grade line calculations for the discharge channel indicate the outfall will be free during major storms. Hydraulic grade line evaluations should proceed upstream from:

1. A demonstrated free overflow; or
2. The expected 1% probability in any 1-year flood elevation at the most downstream point analyzed; or
3. An alternative assumption demonstrated to be appropriate and conservative.

### Depressional Storage

Depressional storage does not have a direct surface outlet. If it is part of a Subsurface Drainage System, it is more than likely drained by a tile and should definition be modeled as “empty” at the beginning of a storm. Flood storage on-site with a positive surface outlet does not need to be compensated for, except when it qualifies as floodplain storage in Article 4 or when its loss causes a violation of a requirement of Section 9-81. A positive surface outlet does not include any type of agricultural surface inlets into an agricultural subsurface drainage system.

The function of an existing depressional storage should be modeled using an event hydrograph model acceptable event hydrograph models are listed in Section 9-84 C. to determine the volume of storage that exists and its effect on existing site release rate. In order to prepare such a model, certain information must be obtained, including delineating the tributary drainage area, the stage-storage relationship and discharge rating curve, and identifying the capacity and elevation of the outlet(s).

The tributary area should be delineated on the best available topographic data. When the tributary area is confined to the project site, the site topographic map (1' contour interval) needs to be used. If the tributary area to the depressional storage extends beyond the project limits, the Kane County 1-foot topographic maps should be used to supplement on-site survey data. If County maps are not available, additional topographic survey may be required.

After determining the tributary area, a hydrologic analysis of the watershed should be performed, including a calculation of the appropriate composite runoff curve number and time of concentration. Stage-storage data for the depressional area can be obtained from the site topographic map. The outlet

should be clearly marked and any calculations performed to create a stage-discharge rating curve should be included with the stormwater submittal.

A critical duration analysis should be performed within the depressional storage and the corresponding storage volume. The 100-year recurrence interval storm should be used for the 1-, 2-, 3-, 6-, 12-, 18-, 24-, 48-, 72-, 120- and 240-hour storm events.

Any depressional storage to be filled by the proposed development needs to be compensated for at a 1:1 ratio. If the entire existing tributary area is conveyed to the site runoff storage facility, the compensatory storage needs to be provided in the facility. If the off-site area tributary to the depressional area is not conveyed to the detention basin, a separate detention basin may be required at the location of the existing depressional storage location so off-site flow is attenuated to the same degree in pre-project compared to in post-project conditions. The required compensatory storage should be added to the site storage requirement, and this total volume requirement should be provided according to Section 9-84 D.

#### Flow Depths on Roadways

The major stormwater system may use roadways for conveyance of flows if such use of roadways is not otherwise prohibited (e.g., use of major traffic routes may be prohibited by highway regulations for safety reasons). In cases where roadways are included in the major drainage system, the depth of flow needs to be calculated by the hydraulic methods described in T9-83. Figure T9-83.B helps explain the criteria of the Ordinance regarding the maximum allowable flow depths on roadways. The velocity of the flow also needs to be determined to ensure that the product of the velocity and the depth on the roadway or crossing does not exceed a value of four (4).



Figure T9-83.B  
 Maximum Allowable Flow Depths on Roadways

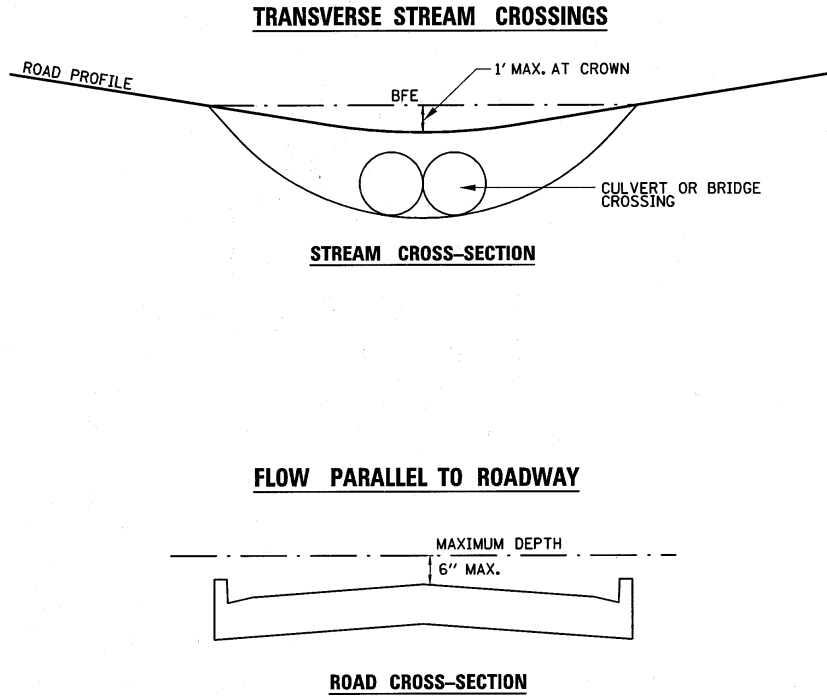

**Diversions of Flow to Another Watershed**

The criteria of Section 9-83.J of the Ordinance can be met best by designing all post-project runoff flow to a discharge from the site at the same location where it drained in pre-project conditions. Illinois drainage law must be consulted about diversions and this Ordinance does not allow diversions prohibited by Illinois drainage law.

If the developer desires to change the discharge locations, it will be necessary to calculate flows and hydraulic grade lines on all affected waterways for both the minor system design criteria and the major system design criteria, and to verify that the resultant hydraulic grade lines are below low entry point elevations or other damaging elevations.

The calculations should extend down both affected drainageways to the point where the pre-diversion flow direction joins the post-diversion flow stream, and up the affected drainageways to the point where the pre-diversion hydraulic grade line is calculated to be within 0.1 foot of the post-diversion hydraulic grade line. If any of these drainageways have defined floodplains, the calculations must be accomplished in accordance with the guidance for floodplain hydraulic analysis.

## Stormwater System Easements

Developed land should be graded to drain to an existing public easement on the property (e.g., a public utility easement or existing drainage easement). If no such easement exists on the property, easements providing public access for maintenance needs to be granted on the property title for any stormwater structures (e.g., culverts, swales, ponds).

For development sites, the easement determination criteria required are:

1. Mapping of both the major and minor stormwater systems.
2. Mapping of an easement sufficient for maintenance for each of the stormwater facilities shown. A sufficient maintenance easement should be at least 10 feet wide around the perimeter of storage basins and along the drainageway and extend continuously from a public roadway.
3. Dedication of the mapped easement on all plats or titles of all parcels containing the easement. The dedication must indicate clearly that the purpose of the easement is for maintenance access to the stormwater facilities. This requirement does not require access for other public purposes, such as trails. {move to Section that includes easements for all conditions under this ordinance including wetlands, floodplain, etc.

### § T9-84 Detention Storage Facilities Requirement

#### Release Rate

The peak release rate from a development site may not exceed 0.1 cfs/acre of development for the 0.01 probability in any year. The Ordinance release rate is a conservative public policy decision setting a uniform standard and level of protection. It is reflective of the relatively low capacity of stormwater infrastructure in Kane County.

The minimum outlet restrictor diameter size is 4-inches. This diameter size is appropriate to minimize the chance of clogging the restrictor opening. However, if the downstream drainage conditions require an outlet size smaller than 4-inches, appropriate protection of the outlet needs to be designed to avoid the opening from being plugged.

The allowable release rate is to be calculated by determining the tributary area at the point of discharge. If the site has more than one outlet, the allowable release for each discharge point needs to be calculated based on the tributary area to that particular outlet.

## Design Methods

In order to calculate the required storage volume, it is necessary that an event hydrograph routing method be used. There are several computer programs developed explicitly for determining the required storage volume using event hydrograph routing methods. Acceptable models include HEC-HMS, SWMM, TR-20 or TR-55 tabular method. The HEC-1 and HEC-HMS are U.S. Army U.S. Army Corps of Engineers hydrologic models. TR-20 and TR-55 were developed by the Soil Conservation Service (now named the Natural Resources Conservation Service).

The HEC programs can be downloaded at the link below:

[https://github.com/HydrologicEngineeringCenter/hec-downloads/releases/download/1.0.7/HEC-RAS\\_507\\_Setup.exe](https://github.com/HydrologicEngineeringCenter/hec-downloads/releases/download/1.0.7/HEC-RAS_507_Setup.exe)

The TR-20 program can be downloaded at the link below:

[http://www.wcc.nrcs.usda.gov/ftpref/wntsc/H&H/WinTR20/WinTR-20\\_Setup\\_Version3.20.exe](http://www.wcc.nrcs.usda.gov/ftpref/wntsc/H&H/WinTR20/WinTR-20_Setup_Version3.20.exe)

The SWMM program can be downloaded at the link below:

[https://www.epa.gov/sites/production/files/2018-08/swmm51013\\_setup\\_1.exe](https://www.epa.gov/sites/production/files/2018-08/swmm51013_setup_1.exe)

All event hydrograph routing methods need to use the most current Huff rainfall distribution appropriate for the storm duration as shown in Tables T9-83.A and T9-83.B. Rainfall depths for different frequencies and durations are shown in Table T9-83. in § T202(f). Figure 6 shows the four Huff Quartile Distributions in graphical format. The only exception to using the Huff Quartile Distributions is when the TR-55 tabular method is used. When using the TR-55 tabular method it is acceptable to use the SCS Type II rainfall distribution. An antecedent moisture condition of 2 must be used when using the WinTR-20 event hydrograph program.

TABLE T9-84.A  
Huff Rainfall Distributions

Rainfall Duration (hours)	Huff Distribution
1	1 <sup>st</sup>
2	1 <sup>st</sup>
3	1 <sup>st</sup>
6	1 <sup>st</sup>
12	2 <sup>nd</sup>
18	3 <sup>rd</sup>
24	3 <sup>rd</sup>
48	4 <sup>th</sup>
72	4 <sup>th</sup>
120	4 <sup>th</sup>
240	4 <sup>th</sup>

TABLE T9-84.B  
Huff Quartile Distributions\*

Cumulative Storm Percentage	Percent of Total Rainfall			
	1 <sup>st</sup> Quartile	2 <sup>nd</sup> Quartile	3 <sup>rd</sup> Quartile	4 <sup>th</sup> Quartile
05	16	03	03	02
10	33	08	06	05
15	43	12	09	08
20	52	16	12	10
25	60	22	15	13
30	66	29	19	16
35	71	39	23	19
40	75	51	27	22
45	79	62	32	25
50	82	70	38	28
55	84	76	45	32
60	86	81	57	35
65	88	85	70	39
70	90	88	79	45
75	92	91	85	51
80	94	93	89	59
85	96	95	92	72
90	97	97	95	84
95	98	98	97	92

\* Applies to drainage areas less than 10 square miles.

FIGURE T9-84.A  
 Median Time Distribution of Heavy Storm Rainfall at a Point  
 (Reference: ISWS, 1992; Rainfall Frequency Atlas of the Midwest)

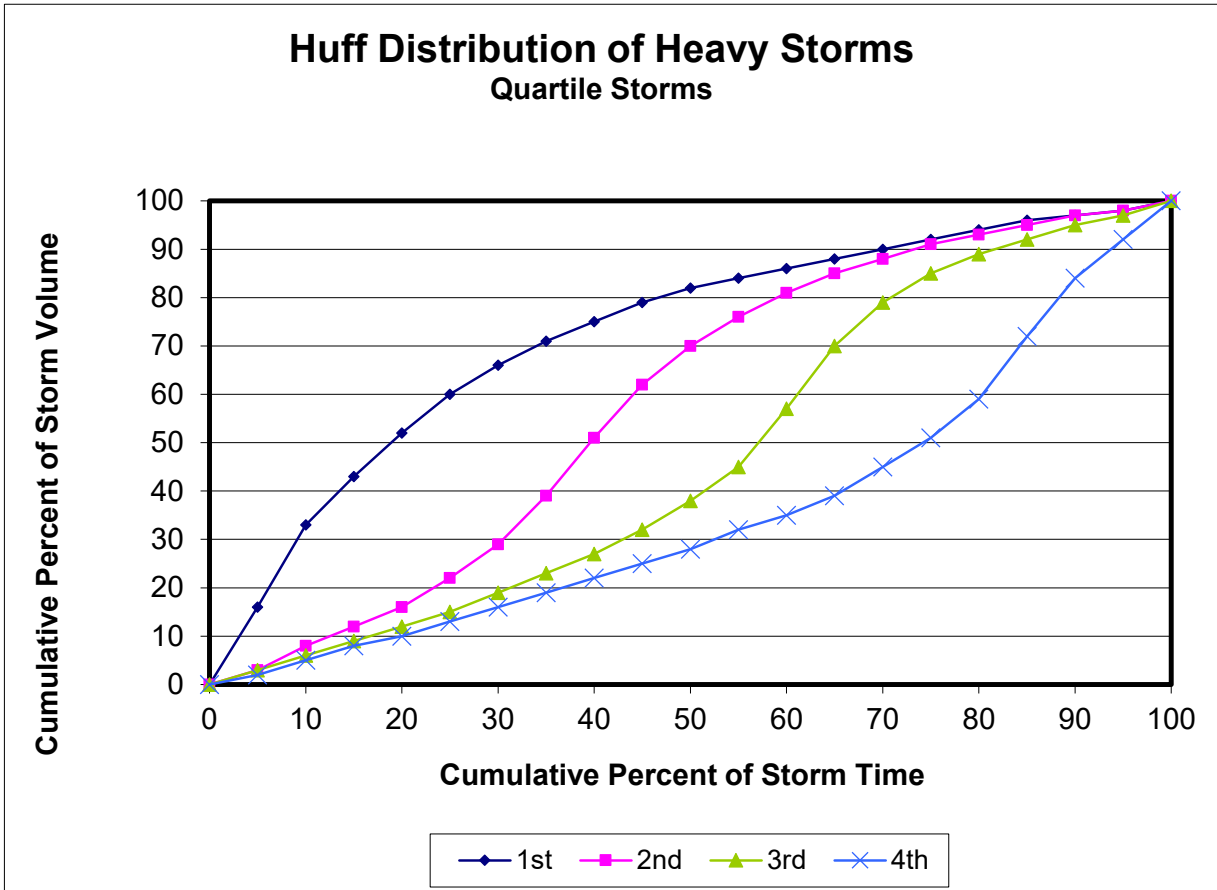

Site Runoff Storage Facility Design Guidelines

The steps in designing the site runoff storage facility are as follows:

Assessment of Existing Conditions:

1. Determine the site and development area and the natural outlet point(s).
2. Calculate any off-site tributary areas and the corresponding peak runoff rate from the 100-year, critical duration design storm event.
3. Determine if regulatory floodplain or floodway exists on the development site.
4. Determine the volume of any depressional storage volume on the development site.

5. Calculate the existing release rate from the site for the 100-year critical duration storm event, accounting for any depressional storage.

#### Planning Phase:

1. Determine the approximate location(s) of stormwater storage facilities and the existing outlets, including invert/overland flow elevations.
2. Calculate the total tributary area associated with each stormwater storage facility location.
3. Calculate the onsite Hydrologically Disturbed Area, area of land cover disturbance, or a combination thereof within the tributary areas associated with each detention storage facility and determine the design release rate. Size the detention volume based upon the above and the design release rate.
4. Approximate the fluctuation in water depth (bounce) due to site topography and the outlet elevation. Subtract 1 to 2 feet from the bounce for controlling the existing conditions pre-development peak runoff rate from the 100-year, critical duration rainfall event that will be conveyed should the primary restrictor in the detention facility become blocked. Depending on the required volume and storage facility configuration, the 100-year existing conditions pre-development peak runoff rate could be controlled with less than 1 foot of fluctuation over the design high water elevation.

#### Detailed Design Phase

1. Use an event hydrograph routing method to iterate the size of the detention pond knowing the design release rate, an approximate storage volume, and anticipated bounce elevation, and modeling the inflow hydrograph from the development area.
2. Once the high water elevation is determined, add the volume of any depressional storage volumes determined for the development site tributary to the detention storage facility. This new volume will yield a new corresponding high water elevation (HWE). Based upon the new HWL, modify the restrictor orifice size to comply with the design release rate. An iterative process is required to determine a final restrictor size and new HWE. The new HWE determines the elevation of the emergency overflow structure.
3. The overflow structure needs to be sized based upon the critical duration of total tributary area to the detention facility.

4. If any off-site tributary area is routed through the detention facility, increase the orifice size to allow for off-site tributary flow based upon a release rate under developed conditions of 0.10 cfs/acre. The new discharge is considered the Allowable Release Rate. Resize the overflow structure to accommodate the remainder of the flow determined from the critical duration analysis.
5. Once the off-site tributary flow is incorporated into the hydrologic model and a new HWE is established, the top of the berm elevation shall provide a minimum of a one foot of freeboard.

### Managing Offsite Flows

Offsite flow onto a development can be managed in several ways. The flow can be by-passed around the development or managed through the site. The offsite flow can be directed through a proposed detention facility. Design factors need to be accounted for including sizing of the restrictor, the overflow outlet, the downstream outfall and the freeboard requirements. The amount of offsite flow shall be determined through a critical duration analysis as illustrated in the following example.

**Example:** A development has an off-site drainage area of 100 acres as delineated on the Kane County 2-foot topographic map. The time of concentration for the off-site area is 1.5 hours, and the Runoff Curve Number is 80. Determine the critical duration and peak discharge to be by-passed through the development.

**Solution:** A TR-20 hydrologic model was used for the critical duration analysis. The following data was input to the model:

Drainage Area =	0.15625 square miles (100ac)
Time of Concentration =	1.5 hours
Runoff Curve Number =	80

The rainfall tables used (RAINFL 6, 7, 8, 9) are the Huff 1<sup>st</sup>, 2<sup>nd</sup>, 3<sup>rd</sup>, and 4<sup>th</sup> quartile distributions. The rainfall depths used are ISWS Bulletin 70 values, as listed in Table 2. The TR-20 hydrologic model input/output is listed below.

**Table T9-84.C**  
**Median Time Distribution of Heavy Storm Rainfall at a Point**

\*\*\*\*\*80-80 LIST OF INPUT DATA FOR TR-20 HYDROLOGY\*\*\*\*\*

JOB TR-20				NOPLOTS			
TITLE	Kane County Technical Manual						
TITLE	Critical Duration Analysis Example			JJJ APROO			
5 RAINFL	6	0.05				HUFF 1ST	
8	0.00	0.16	0.33	0.43	0.52	QUARTILE	
8	0.60	0.66	0.71	0.75	0.79		
8	0.82	0.84	0.86	0.88	0.90		
8	0.92	0.94	0.96	0.97	0.98		
8	1.	1.	1.	1.	1.		
9 ENDTBL							
5 RAINFL	7	0.05				HUFF 2ND	
8	0.00	0.03	0.08	0.12	0.16	QUARTILE	
8	0.22	0.29	0.39	0.51	0.62		
8	0.70	0.76	0.81	0.85	0.88		
8	0.91	0.93	0.95	0.97	0.98		
8	1.	1.	1.	1.	1.		
9 ENDTBL							
5 RAINFL	8	0.05				HUFF 3RD	
8	0.00	0.03	0.06	0.09	0.12	QUARTILE	
8	0.15	0.19	0.23	0.27	0.32		
8	0.38	0.45	0.57	0.70	0.79		
8	0.85	0.89	0.92	0.95	0.97		
8	1.00	1.00	1.00	1.00	1.00		
9 ENDTBL							
5 RAINFL	9	0.05				HUFF 4TH	
8	0.00	0.02	0.05	0.08	0.10	QUARTILE	
8	0.13	0.16	0.19	0.22	0.25		
8	0.28	0.32	0.35	0.39	0.45		
8	0.51	0.59	0.72	0.84	0.92		
8	1.	1.	1.	1.	1.		
9 ENDTBL							
6 RUNOFF	1	1	2 .15625	80.	1.50	1 100ac	
ENDATA							
7 INCREM	6	1.00					
7 COMPUT	7	1	1	0.0	3.56	1.	6 2
ENDCMP	1						
7 COMPUT	7	1	1	0.0	4.47	2.	6 2
ENDCMP	1						
7 COMPUT	7	1	1	0.0	4.85	3.	6 2
ENDCMP	1						
7 COMPUT	7	1	1	0.0	5.68	6.	6 2
ENDCMP	1						
7 COMPUT	7	1	1	0.0	6.59	12.	7 2
ENDCMP	1						
7 COMPUT	7	1	1	0.0	6.97	18.	8 2
ENDCMP	1						

\*\*\*\*\*80-80 LIST OF INPUT DATA (CONTINUED)\*\*\*\*\*

7 COMPUT	7	1	1	0.0	7.58	24.	8 2	1 24hr
ENDCMP	1							
7 COMPUT	7	1	1	0.0	8.16	48.	9 2	1 48hr
ENDCMP	1							
7 COMPUT	7	1	1	0.0	8.78	72.	9 2	1 72hr
ENDCMP	1							
7 COMPUT	7	1	1	0.0	9.96	120.	9 2	1 120hr
ENDCMP	1							
7 COMPUT	7	1	1	0.0	11.14	240.	9 2	1 240hr
ENDCMP	1							
ENDJOB	2							

0\*\*\*\*\*END OF 80-80 LIST\*\*\*\*\*



## Table T9-84.C

### Median Time Distribution of Heavy Storm Rainfall at a Point (continued)

SUMMARY TABLE 1 - SELECTED RESULTS OF STANDARD AND EXECUTIVE CONTROL INSTRUCTIONS IN THE ORDER PERFORMED  
 (A STAR(\*) AFTER THE PEAK DISCHARGE TIME AND RATE (CFS) VALUES INDICATES A FLAT TOP HYDROGRAPH  
 A QUESTION MARK(?) INDICATES A HYDROGRAPH WITH PEAK AS LAST POINT.)

SECTION/ STRUCTURE ID	STANDARD CONTROL OPERATION	DRAINAGE AREA (SQ MI)	RAIN TABLE #	ANTEC MOIST COND	MAIN TIME INCREM (HR)	PRECIPITATION			RUNOFF AMOUNT (IN)	PEAK DISCHARGE				
						BEGIN (HR)	AMOUNT (IN)	DURATION (HR)		ELEVATION (FT)	TIME (HR)	RATE (CFS)	RATE (CSM)	
ALTERNATE		0	STORM	1										
+														
XSECTION	1	RUNOFF	.16	6	2	1.00	.0	3.56	1.00	1.81	---	1.34	91.84	587.8
XSECTION	1	RUNOFF	.16	6	2	1.00	.0	4.47	2.00	2.48	---	1.82	111.32	712.5
XSECTION	1	RUNOFF	.16	6	2	1.00	.0	4.85	3.00	2.75	---	2.03	112.13	717.7
XSECTION	1	RUNOFF	.16	6	2	1.00	.0	5.68	6.00	3.44	---	2.28	103.48	662.2
XSECTION	1	RUNOFF	.16	7	2	1.00	.0	6.59	12.00	4.31	---	6.02	88.89	568.9
XSECTION	1	RUNOFF	.16	8	2	1.00	.0	6.97	18.00	4.66	---	12.18	77.53	496.2
XSECTION	1	RUNOFF	.16	8	2	1.00	.0	7.58	24.00	5.22	---	15.92	67.74	433.5
XSECTION	1	RUNOFF	.16	9	2	1.00	.0	8.16	48.00	5.76	---	41.30	39.02	249.7
XSECTION	1	RUNOFF	.16	9	2	1.00	.0	8.78	72.00	6.36	---	61.20	28.64	183.3
XSECTION	1	RUNOFF	.16	9	2	1.00	.0	9.96	120.00	7.47	---	101.62	20.08	128.5
XSECTION	1	RUNOFF	.16	9	2	1.00	.0	11.14	240.00	8.61	---	204.00	11.38	72.8

TR20 XEQ 10-18-00 13:01 Kane County Technical Manual JOB 1 SUMMARY  
 REV PC 09/83(.2) Critical Duration Analysis Example JJJ APROO PAGE 5

SUMMARY TABLE 3 - DISCHARGE (CFS) AT XSECTIONS AND STRUCTURES FOR ALL STORMS AND ALTERNATES

XSECTION/ STRUCTURE ID	DRAINAGE AREA (SQ MI)	STORM NUMBERS.....
0 XSECTION	1	.16
+		
ALTERNATE	0	11.38
END OF 1 JOBS IN THIS RUN		

Summary Table 1 shows that the peak discharge from the 100 acre offsite basin is 112 cfs, and the corresponding critical duration is the 3-hour event.

FIGURE T9-84.B  
Separation for Subsurface Drainage Pipes and  
Detention Pond Discharge Pipes

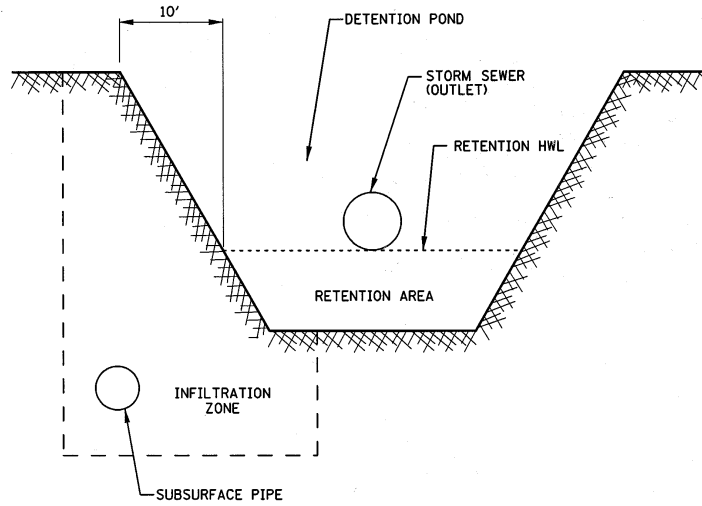

### Detention Storage Facility Examples

Using the examples previously illustrated in T9-81, these examples will provide further guidance for the design of detention storage facilities.

*Example T9-84.A*



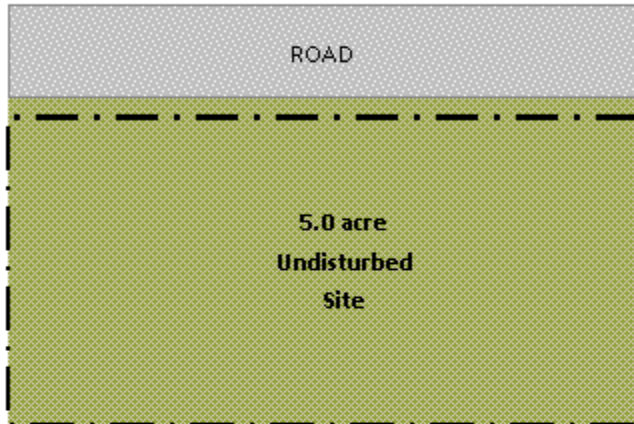

Development of an undisturbed 5 acre Site is proposed with a commercial warehouse and a parking lot resulting in 2 acres of New Impervious Area and 1 acre of pervious Hydrologically Disturbed Area.

Existing Site:

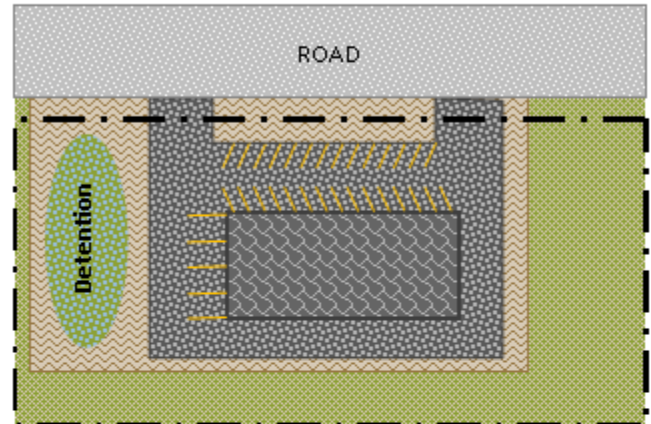

Proposed Site:



-  Existing Undisturbed (not a Hydrologically Disturbed Area) = 5.0 acres
-  Existing Impervious = 0 sq. ft.
-  Proposed Pervious (Hydrologically Disturbed Area) = 1.0 acre
-  New Impervious Area (Hydrologically Disturbed Area) = 2.0 acres

Total Impervious Area =  $2 / 5 = 0.4 * 100 = 40\%$  of Site area

Detention Required = Yes > 25,000 sq. ft. New Impervious Area and greater than 1% of the Site area

Stormwater Mitigation/BMP = Yes, New Impervious Area > 5,000 sq. ft. and greater than 1% of the Site area

*Example T9-84.A (continued)*

The Developer plans to provide a Detention Storage Facility and Stormwater Mitigation BMPs in separate locations on-site. The existing on-site 1% Critical Duration Storm at the Outlet is 5.0 cfs. The Detention Storage Facility Outlet elevation is 775.0 ft. The Site topography allows for 4-ft of bounce.

Step 1: Determine Hydrologically Disturbed Area (HDA)

$$\begin{aligned} HDA &= P_{HDA} + NI_{HDA} \\ 1.0 \text{ ac} + 2.0 \text{ ac} &= 3.0 \text{ ac} \end{aligned}$$

*Where:*

Proposed Pervious Hydrologically Disturbed Area ( $P_{HDA}$ ) = 1.0 acre

New Impervious Hydrologically Disturbed Area ( $NI_{HDA}$ ) = 2.0 acre

Step 2: Determine Detention Storage Volume

$$\begin{aligned} HDA \text{ Allowable Release Rate} &= HDA \times 0.10 \text{ cfs/ac} \\ HDA \text{ Allowable Release Rate} &= 3 \text{ ac} \times 0.10 \text{ cfs/ac} = 0.30 \text{ cfs} \end{aligned}$$

Using event hydrograph method (TR-20, et al) for site conditions, determine required detention storage volume and high water elevation. The restrictor size is iterated until the maximum HDA allowable Release Rate is met. For this example, it was determined that:

Restrictor Size = 2.5" Diameter

Required Detention Volume = 1.4 ac-ft

High Water Elevation = 778.0

Step 3: Determine Emergency Overflow Weir Elevation

$$\text{Emergency Overflow Elevation} = HWE = 778.0 \text{ ft}$$

Step 4: Determine Modified Allowable Release Rate for Total Tributary Area

$$\begin{aligned} \text{Modified Allowable Release Rate for Total Tributary Area} &= A \times 0.10 \text{ cfs/ac} \\ \text{Modified Allowable Release Rate} &= 5 \text{ ac} \times 0.10 \text{ cfs/ac} = 0.50 \text{ cfs} \end{aligned}$$

*Where:*

A is the Tributary Area

$$A = P_{HDA} + NI_{HDA} + P_{UA} = 1.0 \text{ ac} + 2.0 \text{ ac} + 2.0 \text{ ac} = 5 \text{ ac}$$

Proposed Pervious Hydrologically Disturbed Area ( $P_{HDA}$ ) = 1.0 acre

New Impervious Hydrologically Disturbed Area ( $NI_{HDA}$ ) = 2.0 acre

Pervious Undisturbed Area ( $P_{UA}$ ) = 2.0 acres

*Example T9-84.A (continued)*

Step 5: Determine Restrictor Size for Modified Allowable Release Rate

$$\text{Orifice Diameter (inches)} = \left( \frac{4 \times Q}{0.6 \times \pi \times (2 \times g \times H)^{0.5}} \right)^{0.5} \times \left( \frac{12 \text{ in}}{1 \text{ ft}} \right)$$
$$\text{Orifice Diameter (inches)} = \left( \frac{4 \times 0.5}{0.6 \times \pi \times (2 \times 32.2 \times 3.0)^{0.5}} \right)^{0.5} \times \left( \frac{12 \text{ in}}{1 \text{ ft}} \right) = 3.32''$$

Where:

Q = Flowrate (cfs)

g = acceleration of gravity = 32.2 ft/s<sup>2</sup>

H = head (ft)

$$H = \text{HWE} - \text{NWE} = 778.0\text{ft} - 775.0\text{ft} = 3.0\text{ft}$$

High Water Elevation (HWE): 778.0

Normal Water Elevation (NWE): 775.0

New restrictor: 3.32" Dia @3.0ft TDH or 4.0" Dia. Min. orifice size

Step 6: Set Freeboard Elevation

$$\text{Freeboard} = \text{HWE} + 1\text{ft} = 779.0\text{ft}$$

*Example T9-84.B*



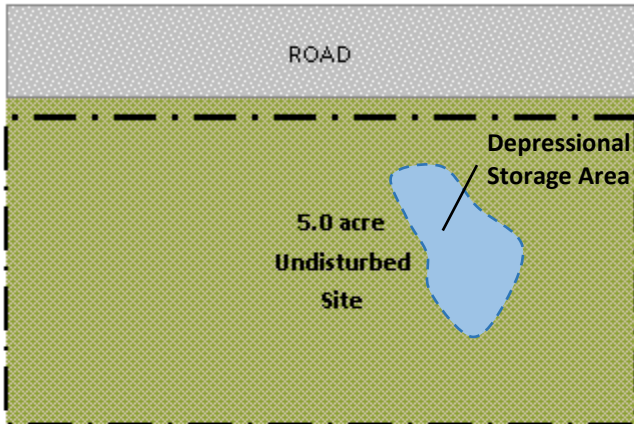

Development of an undisturbed 5 acre Site is proposed with a commercial warehouse and a parking lot resulting in 2 acres of New Impervious Area and 1 acre of pervious Hydrologically Disturbed Area.

Existing Site:

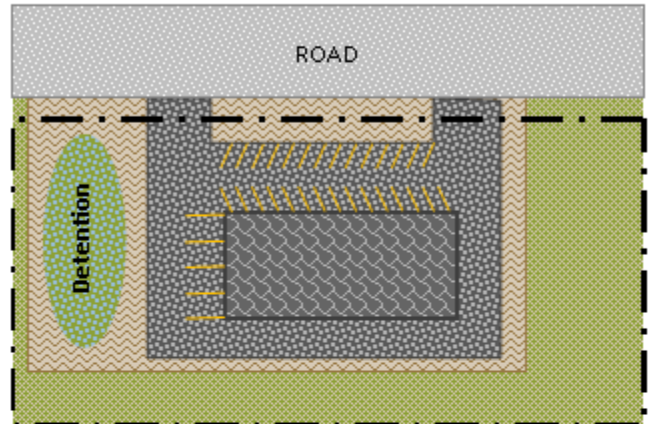

Proposed Site:



-  Existing Undisturbed (not a Hydrologically Disturbed Area) = 5.0 acres
-  Existing Impervious = 0 sq. ft.
-  Proposed Pervious (Hydrologically Disturbed Area) = 1.0 acre
-  New Impervious Area (Hydrologically Disturbed Area) = 2.0 acres

Total Impervious Area =  $2 / 5 = 0.4 * 100 = 40\%$  of Site area

Detention Required = Yes > 25,000 sq. ft. New Impervious Area and greater than 1% of the Site area

Stormwater Mitigation/BMP = Yes, New Impervious Area > 5,000 sq. ft. and greater than 1% of the Site area

*Example T9-84.B (continued)*

The Developer plans to provide a Detention Storage Facility and Stormwater Mitigation BMPs in separate locations on-site. The existing on-site 1% Critical Duration Storm at the Outlet is 4.8 cfs. The on-site Depressional Storage area has a Volume of 0.20 ac-ft. The Detention Storage Facility Outlet elevation is 775.0 ft. The Site topography allows for 4-ft of bounce.

Step 1: Determine Hydrologically Disturbed Area (HDA)

$$\begin{aligned} \text{HDA} &= P_{\text{HDA}} + NI_{\text{HDA}} \\ 1.0 \text{ ac} + 2.0 \text{ ac} &= 3.0 \text{ ac} \end{aligned}$$

*Where:*

Proposed Pervious Hydrologically Disturbed Area ( $P_{\text{HDA}}$ ) = 1.0 acre

New Impervious Hydrologically Disturbed Area ( $NI_{\text{HDA}}$ ) = 2.0 acre

Step 2: Determine Detention Storage Volume

$$\begin{aligned} \text{HDA Allowable Release Rate} &= \text{HDA} \times 0.10 \text{ cfs/ac} \\ \text{HDA Allowable Release Rate} &= 3 \text{ ac} \times 0.10 \text{ cfs/ac} = 0.30 \text{ cfs} \end{aligned}$$

Using event hydrograph method (TR-20, et al) for site conditions, determine required detention storage volume and high water elevation. The restrictor size is iterated until the maximum HDA allowable Release Rate is met. For this example, it was determined that:

Restrictor Size = 2.5" Diameter

Required Detention Volume = 1.4 ac-ft

High Water Elevation = 778.0

Step 3: Determine Emergency Overflow Weir Elevation

$$\begin{aligned} \text{Total Volume Required in Detention Storage Facility} &= \\ \text{Detention Volume} + \text{Depressional Storage Volume} &= 1.4 \text{ acft} + 0.2 \text{ acft} = 1.6 \text{ acft} \end{aligned}$$

Based upon the Detention Storage Facility dimensions, the developer calculates that the 1.6 ac-ft volume equates to a new high-water elevation of 778.50.

Step 4: Determine Modified Allowable Release Rate for Total Tributary Area

$$\begin{aligned} \text{Modified Allowable Release Rate for Total Tributary Area} &= A \times 0.10 \text{ cfs/ac} \\ \text{Modified Allowable Release Rate} &= 5 \text{ ac} \times 0.10 \text{ cfs/ac} = 0.50 \text{ cfs} \end{aligned}$$

*Where:*

A is the Tributary Area

$$A = P_{\text{HDA}} + NI_{\text{HDA}} + P_{\text{UA}} = 1.0 \text{ ac} + 2.0 \text{ ac} + 2.0 \text{ ac} = 5 \text{ ac}$$

Proposed Pervious Hydrologically Disturbed Area ( $P_{\text{HDA}}$ ) = 1.0 acre

New Impervious Hydrologically Disturbed Area ( $NI_{\text{HDA}}$ ) = 2.0 acre

Pervious Undisturbed Area ( $P_{\text{UA}}$ ) = 2.0 acres

**Example T9-84.B (continued)**

Step 5: Determine Restrictor Size for Modified Allowable Release Rate

$$\text{Orifice Diameter (inches)} = \left( \frac{4 \times Q}{0.6 \times \pi \times (2 \times g \times H)^{0.5}} \right)^{0.5} \times \left( \frac{12 \text{ in}}{1 \text{ ft}} \right)$$

$$\text{Orifice Diameter (inches)} = \left( \frac{4 \times 0.5}{0.6 \times \pi \times (2 \times 32.2 \times 3.5)^{0.5}} \right)^{0.5} \times \left( \frac{12 \text{ in}}{1 \text{ ft}} \right) = 3.19''$$

Where:

Q = Flowrate (cfs)

g = acceleration of gravity = 32.2 ft/s<sup>2</sup>

H = head (ft)

$$H = \text{HWE} - \text{NWE} = 778.5\text{ft} - 775.0\text{ft} = 3.5\text{ft}$$

High Water Elevation (HWE): 778.5

Normal Water Elevation (NWE): 775.0

New restrictor: 3.19" Dia @3.5ft TDH or 4.0" Dia. Min. orifice size

Step 6: Set Freeboard Elevation

$$\text{Freeboard} = \text{HWE} + 1\text{ft} = 779.5\text{ft}$$



*Example T9-84.C*



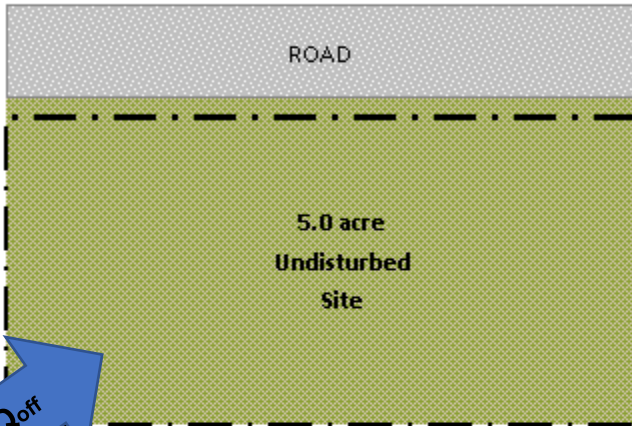

Development of an undisturbed 5 acre Site is proposed with a commercial warehouse and a parking lot resulting in 2 acres of New Impervious Area and 1 acre of pervious Hydrologically Disturbed Area.

Existing Site:

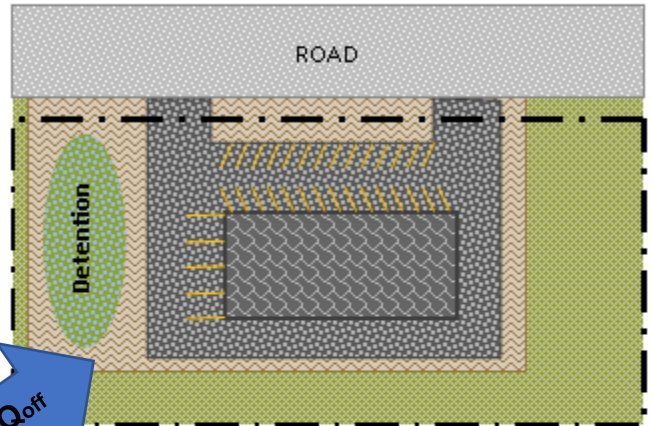

Proposed Site:



-  Existing Undisturbed (not a Hydrologically Disturbed Area) = 5.0 acres
-  Existing Impervious = 0 sq. ft.
-  Proposed Pervious (Hydrologically Disturbed Area) = 1.0 acre
-  New Impervious Area (Hydrologically Disturbed Area) = 2.0 acres

Total Impervious Area =  $2 / 5 = 0.4 * 100 = 40\%$  of Site area

Detention Required = Yes > 25,000 sq. ft. New Impervious Area and greater than 1% of the Site area

Stormwater Mitigation/BMP = Yes, New Impervious Area > 5,000 sq. ft. and greater than 1% of the Site area

*Example T9-84.C (continued)*

The Developer plans to provide a Detention Storage Facility and Stormwater Mitigation BMPs in separate locations on-site. The existing on-site 1% Critical Duration Storm at the Outlet is 5.0 cfs. There is an off-site Tributary Area of 18 acres and the Off-site Tributary flow for 1% Critical Duration Storm is calculated to be 20.0 cfs. The Detention Storage Facility Outlet elevation is 775.0 ft. The Site topography allows for 4-ft of bounce.

Step 1: Determine Hydrologically Disturbed Area (HDA)

$$\begin{aligned} HDA &= P_{HDA} + NI_{HDA} \\ 1.0 \text{ ac} + 2.0 \text{ ac} &= 3.0 \text{ ac} \end{aligned}$$

*Where:*

Proposed Pervious Hydrologically Disturbed Area ( $P_{HDA}$ ) = 1.0 acre

New Impervious Hydrologically Disturbed Area ( $NI_{HDA}$ ) = 2.0 acre

Step 2: Determine Detention Storage Volume

$$\begin{aligned} HDA \text{ Allowable Release Rate} &= HDA \times 0.10 \text{ cfs/ac} \\ HDA \text{ Allowable Release Rate} &= 3 \text{ ac} \times 0.10 \text{ cfs/ac} = 0.30 \text{ cfs} \end{aligned}$$

Using event hydrograph method (TR-20, et al) for site conditions, determine required detention storage volume and high water elevation. The restrictor size is iterated until the maximum HDA allowable Release Rate is met. For this example, it was determined that:

Restrictor Size = 2.5" Diameter

Required Detention Volume = 1.4 ac-ft

High Water Elevation = 778.0

Step 3: Determine Emergency Overflow Weir Elevation

$$\text{Emergency Overflow Elevation} = HWE = 778.0 \text{ ft}$$

Step 4: Determine Modified Allowable Release Rate for Total Tributary Area

$$\begin{aligned} \text{Modified Allowable Release Rate for Total Tributary Area} &= A \times 0.10 \text{ cfs/ac} + \\ \text{Modified Allowable Release Rate} &= 23 \text{ ac} \times 0.10 \text{ cfs/ac} = 2.3 \text{ cfs} \end{aligned}$$

*Where:*

A is the Tributary Area

$$A = P_{HDA} + NI_{HDA} + P_{UA} + A_{OS} = 1.0 \text{ ac} + 2.0 \text{ ac} + 2.0 \text{ ac} + 18.0 \text{ ac} = 23 \text{ ac}$$

Proposed Pervious Hydrologically Disturbed Area ( $P_{HDA}$ ) = 1.0 acre

New Impervious Hydrologically Disturbed Area ( $NI_{HDA}$ ) = 2.0 acre

Pervious Undisturbed Area ( $P_{UA}$ ) = 2.0 acres

Off-Site Tributary Area ( $A_{OS}$ ) = 18.0 acres

*Example T9-84.C (continued)*

Step 5: Determine Restrictor Size for Modified Allowable Release Rate

$$\text{Orifice Diameter (inches)} = \left( \frac{4 \times Q}{0.6 \times \pi \times (2 \times g \times H)^{0.5}} \right)^{0.5} \times \left( \frac{12 \text{ in}}{1 \text{ ft}} \right)$$
$$\text{Orifice Diameter (inches)} = \left( \frac{4 \times 2.3}{0.6 \times \pi \times (2 \times 32.2 \times 3.0)^{0.5}} \right)^{0.5} \times \left( \frac{12 \text{ in}}{1 \text{ ft}} \right) = 7.11''$$

Where:

Q = Flowrate (cfs)

g = acceleration of gravity = 32.2 ft/s<sup>2</sup>

H = head (ft)

$$H = \text{HWE} - \text{NWE} = 778.0\text{ft} - 775.0\text{ft} = 3.0\text{ft}$$

High Water Elevation (HWE): 778.0

Normal Water Elevation (NWE): 775.0

New restrictor: 7.11" Dia @3.0ft TDH

Step 6: Determine the Emergency Overflow Weir Capacity:

$$\text{Weir capacity} = \text{Total off-site flow} + \text{Allowable Release Rate for Site}$$
$$20\text{cfs} + 0.5\text{cfs} = 20.5\text{cfs}$$

Set Freeboard Elevation

Using event hydrograph model with the total tributary area for the critical duration will determine a new High Water Elevation of 778.75.

$$\text{Freeboard} = \text{HWE} + 1\text{ft} = 779.75\text{ft}$$

### Example T9-84.D



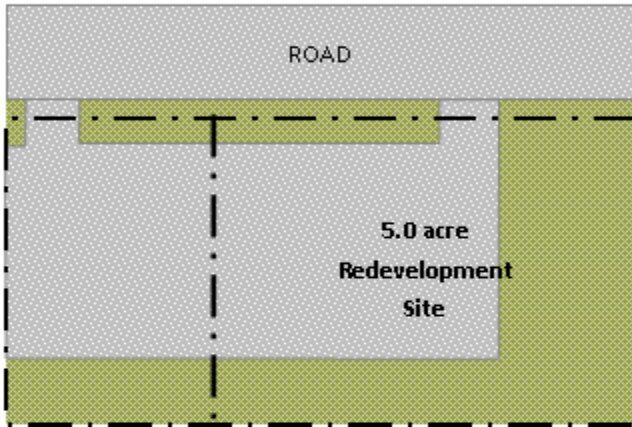

Redevelopment of a 5 acre Site is proposed. An existing 2 acre parking lot will be removed and replaced with a new building and parking lot resulting in 1 acres of Net New impervious Area. The entire Site will be regraded and is a Hydrologically Disturbed Area.

#### Existing Site:

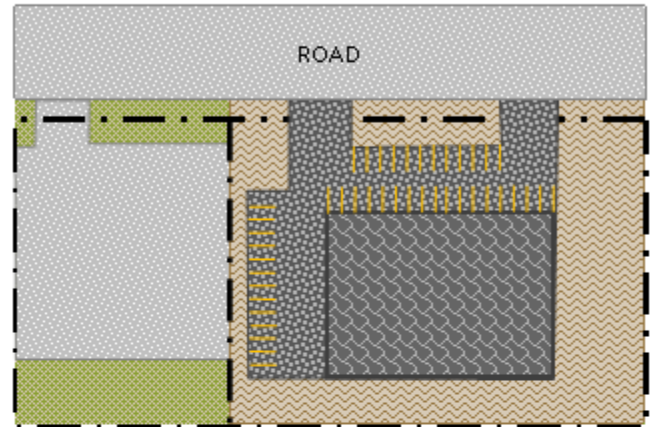

#### Proposed Site:



-  Existing Undisturbed (not a Hydrologically Disturbed Area) = 3.0 acres
-  Existing Impervious = 2.0 acres
-  Proposed Pervious (Hydrologically Disturbed Area) = 2.0 acre
-  Net New Impervious Area (Hydrologically Disturbed) =  
(New Impervious Area - Existing Impervious Area Removed)  
 $3.0 - 2.0 = 1.0$  acre

Total Impervious Area =  $2 / 5 = 0.4 * 100 = 40\%$  of Site area  
 Detention Required = Yes, Net New Impervious Area < 25,000 sq. ft.  
 Yes, Hydrologically Disturbed area > 3 acres  
 Stormwater Mitigation/BMP = Yes, Net New Impervious Area < 25,000 sq. ft.  
 Yes, Hydrologically Disturbed Area > 3 acres

*Example T9-84.D (continued)*

The Developer plans to provide a Detention Storage Facility and Stormwater Mitigation BMPs in separate locations on-site. The existing on-site 1% Critical Duration Storm at the Outlet is 5.0 cfs. The Detention Storage Facility Outlet elevation is 775.0 ft. The Site topography allows for 4-ft of bounce.

Step 1: Determine Hydrologically Disturbed Area (HDA)

$$\begin{aligned} HDA &= P_{HDA} + NI_{HDA} \\ 2.0 \text{ ac} + 3.0 \text{ ac} &= 5.0 \text{ ac} \end{aligned}$$

*Where:*

Proposed Pervious Hydrologically Disturbed Area ( $P_{HDA}$ ) = 3.0 acre

New Impervious Hydrologically Disturbed Area ( $NI_{HDA}$ ) = 3.0 acre

Step 2: Determine Detention Storage Volume

$$\begin{aligned} HDA \text{ Allowable Release Rate} &= HDA \times 0.10 \text{ cfs/ac} \\ HDA \text{ Allowable Release Rate} &= 5 \text{ ac} \times 0.10 \text{ cfs/ac} = 0.50 \text{ cfs} \end{aligned}$$

Using event hydrograph method (TR-20, et al) for site conditions, determine required detention storage volume and high water elevation. The restrictor size is iterated until the maximum HDA allowable Release Rate is met. For this example, it was determined that:

Restrictor Size = 3.25" Diameter or 4" minimum restrictor

Required Detention Volume = 2.4 ac-ft

High Water Elevation = 778.0

Step 3: Determine Emergency Overflow Weir Elevation

Emergency Overflow Weir Design Capacity: 5.0 cfs

$$\text{Emergency Overflow Elevation} = HWE = 778.0 \text{ ft}$$

Step 4: Set Freeboard Elevation

$$\text{Freeboard} = HWE + 1 \text{ ft} = 779.0 \text{ ft}$$

*Example 9-84.E*



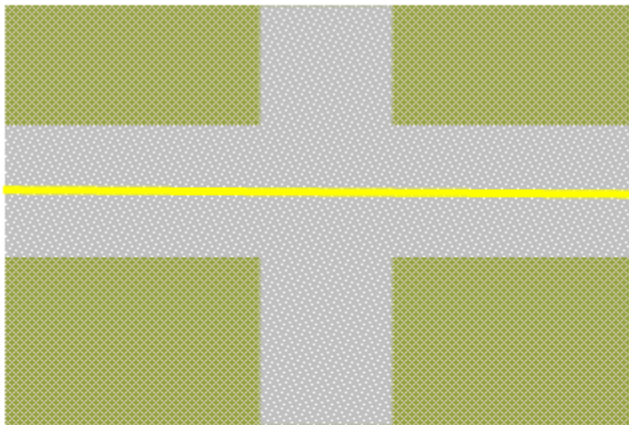

An existing public roadway is being widened to accommodate a 3,630 linear foot middle turn lane and shoulder widening that exceed the maximum width for the designated use. The New Impervious Area exceeds 1 acre in aggregate.

Existing Site:

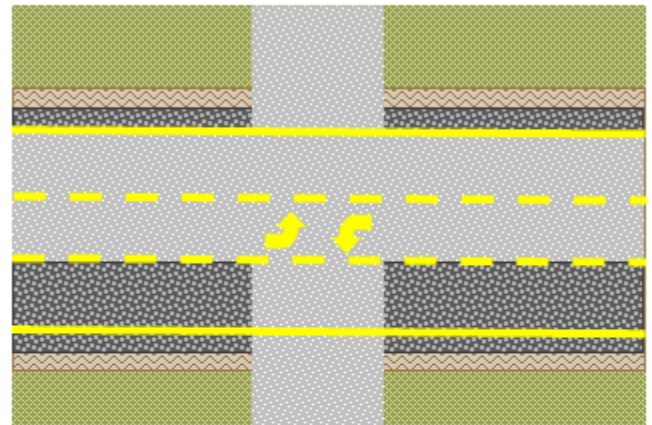

Proposed Site:



-  Existing Undisturbed (not a Hydrologically Disturbed Area) = 2.0 acres
-  Existing Impervious = 2.0 acres (87,120 sq. ft.)
-  Proposed Pervious (Hydrologically Disturbed Area) = 0.5 acre
-  New Impervious Area (Hydrologically Disturbed Area) = 2.25 acres (98,010sq. ft.)

Total Impervious Area = N/A  
 Detention Required = Yes, Net New Impervious Area > 1 acre in aggregate  
 Stormwater Mitigation/BMP = Yes, Net New Impervious Area > 1 acre in aggregate

*Example 9-84.E (continued)*

The Developer plans to provide a Detention Storage Facility and Stormwater Mitigation BMPs in separate locations on-site. The existing on-site 1% Critical Duration Storm at the Outlet is 3.0 cfs. The Detention Storage Facility Outlet elevation is 775.0 ft. The Site topography allows for 2-ft of bounce.

Step 1: Determine Hydrologically Disturbed Area (HDA)

$$\begin{aligned} HDA &= P_{HDA} + NI_{HDA} \\ 0.5 \text{ ac} + 2.25 \text{ ac} &= 2.75 \text{ ac} \end{aligned}$$

*Where:*

Proposed Pervious Hydrologically Disturbed Area ( $P_{HDA}$ ) = 0.5 acre

New Impervious Hydrologically Disturbed Area ( $NI_{HDA}$ ) = 2.25 acre

Step 2: Determine Detention Storage Volume

$$\begin{aligned} HDA \text{ Allowable Release Rate} &= HDA \times 0.10 \text{ cfs/ac} \\ HDA \text{ Allowable Release Rate} &= 2.75 \text{ ac} \times 0.10 \text{ cfs/ac} = 0.275 \text{ cfs} \end{aligned}$$

Using event hydrograph method (TR-20, et al) for site conditions, determine required detention storage volume and high water elevation. The restrictor size is iterated until the maximum HDA allowable Release Rate is met. For this example, it was determined that:

Restrictor Size = 2.75" Diameter

Required Detention Volume = 1.5 ac-ft

High Water Elevation = 777.0

Step 3: Determine Emergency Overflow Weir Elevation

$$\text{Emergency Overflow Elevation} = HWE = 777.0 \text{ ft}$$

Step 4: Determine Modified Allowable Release Rate for Total Tributary Area

$$\begin{aligned} \text{Modified Allowable Release Rate for Total Tributary Area} &= A \times 0.10 \text{ cfs/ac} \\ \text{Modified Allowable Release Rate} &= 4 \text{ ac} \times 0.10 \text{ cfs/ac} = 0.40 \text{ cfs} \end{aligned}$$

*Where:*

A is the Tributary Area

$$A = P_{HDA} + NI_{HDA} + P_{UA} = 0.5 \text{ ac} + 2.25 \text{ ac} + 1.25 \text{ ac} = 4 \text{ ac}$$

Proposed Pervious Hydrologically Disturbed Area ( $P_{HDA}$ ) = 0.5 acre

New Impervious Hydrologically Disturbed Area ( $NI_{HDA}$ ) = 2.25 acre

Pervious Undisturbed Area ( $P_{UA}$ ) = 1.25 acres

*Example 9-84.E (continued)*

Step 5: Determine Restrictor Size for Modified Allowable Release Rate

$$\text{Orifice Diameter (inches)} = \left( \frac{4 \times Q}{0.6 \times \pi \times (2 \times g \times H)^{0.5}} \right)^{0.5} \times \left( \frac{12 \text{ in}}{1 \text{ ft}} \right)$$
$$\text{Orifice Diameter (inches)} = \left( \frac{4 \times 0.4}{0.6 \times \pi \times (2 \times 32.2 \times 2.0)^{0.5}} \right)^{0.5} \times \left( \frac{12 \text{ in}}{1 \text{ ft}} \right) = 3.28''$$

Where:

Q = Flowrate (cfs)

g = acceleration of gravity = 32.2 ft/s<sup>2</sup>

H = head (ft)

$$H = \text{HWE} - \text{NWE} = 777.0\text{ft} - 775.0\text{ft} = 2.0\text{ft}$$

High Water Elevation (HWE): 777.0

Normal Water Elevation (NWE): 775.0

New restrictor: 3.28" Dia @2.0ft TDH or 4.0" Dia. Min. orifice size

Step 6: Set Freeboard Elevation

$$\text{Freeboard} = \text{HWE} + 1\text{ft} = 778.0\text{ft}$$



## Detention Storage Facility Requirements Within the Regulatory Floodplain

The Ordinance does not prohibit the construction of detention storage facilities in the floodplain but requires that their design consider carefully the function of the facility during flood flows. Detention volume sizing shall assume a free discharge, establishing a required volume. However, analysis of the operation of the facility must consider the requirement that existing conditions at the 100-year peak runoff rate not be exceeded where the restrictor is blocked. “Berming off” of existing floodplain storage and on-line storage is highly discouraged. Excavating “new” storage in the floodplain and controlling the discharge while allowing overflow into basins of the stream system for infrequent floods can be beneficial to the watershed.

If it can be shown using detailed hydrologic and hydraulic analysis that the design of a storage facility within the regulatory floodplain provides a watershed benefit, the Administrator may approve the design. To show a watershed benefit, the applicant must demonstrate that there is a decrease in flood elevations for the 100-year, critical design storm event, either upstream and/or downstream of the development site. The decrease in elevation should be greater than 0.1 feet and in no locations, upstream or downstream of the development site should water surface elevations increase.

## ARTICLE V – REQUIREMENTS FOR STORMWATER MITIGATION / BEST MANAGEMENT PRACTICES (BMPS) AND WATERSHED BENEFIT MEASURES

### § T9-107 Requirements for Stormwater Mitigation / BMPs

#### General Requirements

The guidance in this Chapter provides the minimum interpretation of the requirements of the Ordinance. To determine if a Stormwater Management Permit is required for a particular development, the developer should follow the worksheet found on the Kane County website.

Developments that do not require a Stormwater Management Permit are not excluded from obtaining all other appropriate stormwater management related approvals from federal, state and regional authorities.

#### Stormwater Mitigation/Best Management Practice Requirements

The Ordinance provides a table to describe the stormwater mitigation and BMP requirements for all development or redevelopment scenarios. This table is reproduced on the following page.

Table T9-197.A

Development Category	New Impervious Area for Development or Net New Impervious Area for Redevelopment	Stormwater Mitigation / BMP		Fee-in-Lieu <sup>2</sup> (Section)
		Category I (Section)	Category II (Section)	
Development or Redevelopment	< 5,000 sq.ft.	X <sup>1</sup> (9-107.C)		A (9-85)
	5,000 sq.ft. – 24,999 sq.ft.	X (9-107.C)		A (9-85)
	≥ 25,000 sq.ft. AND < 1% Site area		X (9-107.D)	A (9-85)
	≥ 25,000 sq.ft. AND ≥ 1% Site area		X (9-107.D)	A (9-85)
Linear Project (Trails/Roads)	> 1-acre in aggregate for roads and trails that are ≤ AASHTO max. width	X (9-107.C)		A (9-85)
	> 1-acre in aggregate for roads and trails that are > AASHTO max. width		X (9-107.D)	A (9-85)
Total Impervious Area > 50% Site area (for Sites < 1-acre)		X (9-107.C)		A (9-85)
Hydrologically Disturbed Area > 3-acres			X (9-107.D)	A (9-85)
X = Required; A = Allowed				

<sup>1</sup>Required at the discretion of the **Administrator** where known flooding or drainage issues are in the immediate vicinity of the project, in areas without **Adequate Downstream Stormwater Capacity**, or that outlet to a **Volume Sensitive Watershed**.

<sup>2</sup>Fee-in-lieu requires approval of the **Administrator** and compliance with the requirement listed under Subsection 9-81.B.4.

### Category I BMPs

Developments or redevelopments that are required to provide Category I BMPs must provide Volume Reduction and Water Quality Treatment of one-inch (1.0”) of rainfall over the New Impervious Area. The purpose of these practices is to provide pollutant and volume reductions for stormwater runoff from the site prior to the runoff entering downstream properties, sewers, or waters. The required Volume Reduction shall be calculated as the product of the New Impervious Area and a one-inch (1.0”) rainfall event with no abstractions. A graph is provided below for use in this calculation.

Table T9-107

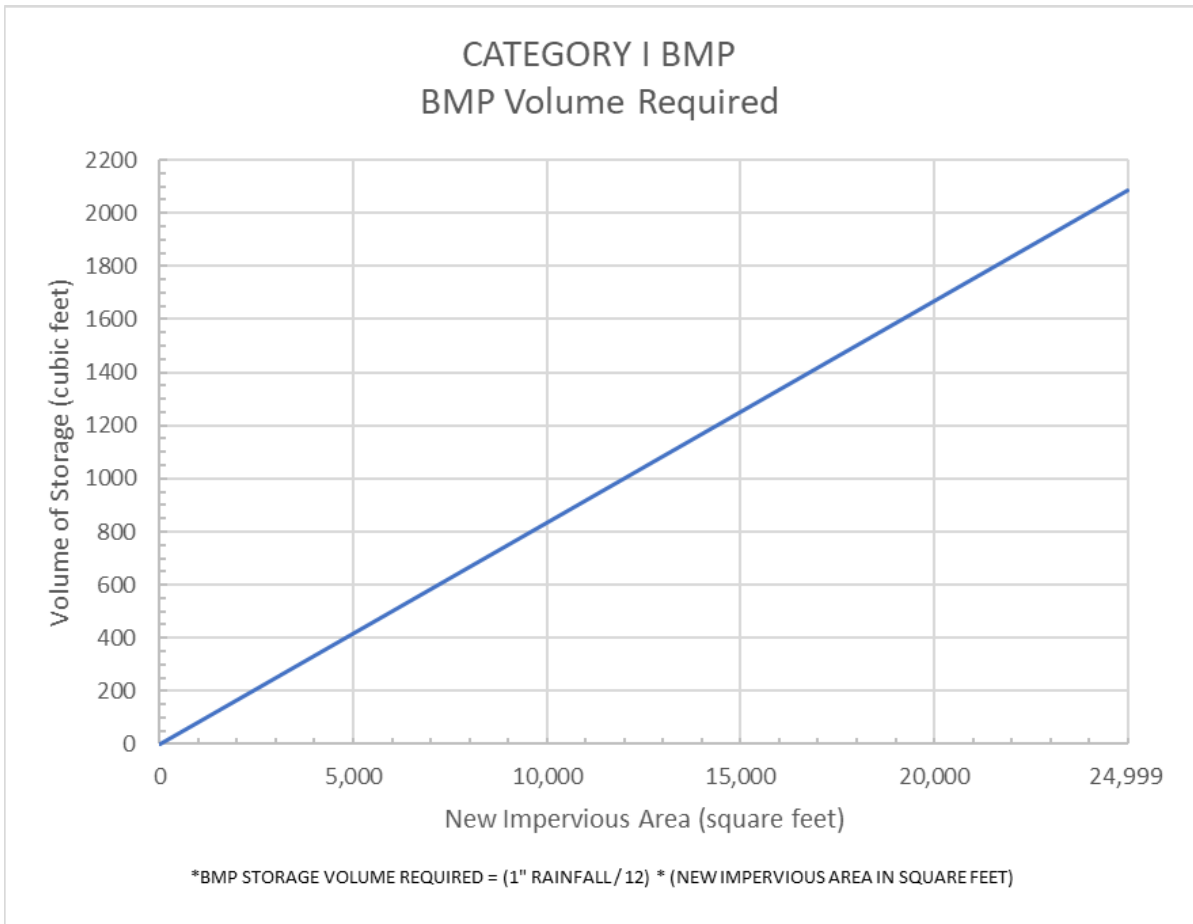

### Category II BMPs

Developments or redevelopments that are required to provide Category II BMPs must also provide Volume Reduction and Water Quality Treatment. The required Volume Reduction may be calculated as the product of the New Impervious Area and a one-inch (1.0") rainfall event with no abstractions. A graph is provided in the previous section for use in this calculation.

Alternatively, the development may be designed such that the post-development infiltration volume matches ninety percent (90%) of the pre-development infiltration volume. This calculation must be a continuous simulation and must be based on the Average Annual Rainfall. It is recommended that the RECARGA program be utilized for this calculation, although alternative modeling programs may be utilized at the approval of the Administrator. The RECARGA program and user manual may be accessed here:

<https://dnr.wi.gov/topic/stormwater/standards/recarga.html>

### Volume Reduction

BMP Volume Reduction may be provided in a variety of practices including, but not limited to, rain gardens, infiltration trenches, permeable paver pavement, manufactured structures, and constructed wetland detention basins. More discussion of BMPs are provided below. Detention storage credit may be given for sites in which infiltration practices are allowable. Practices that include surface storage ponding as BMP Volume Reduction may only count up to twenty-four inches (24") of surface ponding towards detention storage credit.

Additionally, practices may include subsurface storage as BMP Volume Reduction. This subsurface storage generally consists of void space within a uniformly-graded stone, aggregate, or sand layer. Particles less than 1/16 mm are not allowable as BMP volume storage layers. The typical maximum void space within these storage layers is 36%, which shall generally be used for the volume calculation. The applicant may submit testing and analysis of proposed materials in order to prove a higher level of porosity.

In order to aid with the calculation of subsurface storage volume, a BMP Volume Sizing table and BMP Volume Sizing Graph are provided below. The table and graph allow the applicant to choose a variety of subsurface trench lengths and cross-sectional areas (trench depth multiplied by trench width) to determine the volume provided.

Table T9-107.B

<b>BMP Volume Sizing (cubic feet)</b>											
Trench Length (feet)											
		<b>15</b>	<b>30</b>	<b>45</b>	<b>60</b>	<b>75</b>	<b>90</b>	<b>105</b>	<b>120</b>	<b>135</b>	<b>150</b>
Trench Cross-Sectional Area (square feet)	<b>2</b>	10.8	21.6	32.4	43.2	54.0	64.8	75.6	86.4	97.2	108.0
	<b>4</b>	21.6	43.2	64.8	86.4	108.0	129.6	151.2	172.8	194.4	216.0
	<b>6</b>	32.4	64.8	97.2	129.6	162.0	194.4	226.8	259.2	291.6	324.0
	<b>8</b>	43.2	86.4	129.6	172.8	216.0	259.2	302.4	345.6	388.8	432.0
	<b>10</b>	54.0	108.0	162.0	216.0	270.0	324.0	378.0	432.0	486.0	540.0
	<b>12</b>	64.8	129.6	194.4	259.2	324.0	388.8	453.6	518.4	583.2	648.0
	<b>14</b>	75.6	151.2	226.8	302.4	378.0	453.6	529.2	604.8	680.4	756.0
	<b>16</b>	86.4	172.8	259.2	345.6	432.0	518.4	604.8	691.2	777.6	864.0
	<b>18</b>	97.2	194.4	291.6	388.8	486.0	583.2	680.4	777.6	874.8	972.0
	<b>20</b>	108.0	216.0	324.0	432.0	540.0	648.0	756.0	864.0	972.0	1080.0
	<b>22</b>	118.8	237.6	356.4	475.2	594.0	712.8	831.6	950.4	1069.2	1188.0
	<b>24</b>	129.6	259.2	388.8	518.4	648.0	777.6	907.2	1036.8	1166.4	1296.0
	<b>26</b>	140.4	280.8	421.2	561.6	702.0	842.4	982.8	1123.2	1263.6	1404.0
	<b>28</b>	151.2	302.4	453.6	604.8	756.0	907.2	1058.4	1209.6	1360.8	1512.0
	<b>30</b>	162.0	324.0	486.0	648.0	810.0	972.0	1134.0	1296.0	1458.0	1620.0
	<b>32</b>	172.8	345.6	518.4	691.2	864.0	1036.8	1209.6	1382.4	1555.2	1728.0
	<b>34</b>	183.6	367.2	550.8	734.4	918.0	1101.6	1285.2	1468.8	1652.4	1836.0
	<b>36</b>	194.4	388.8	583.2	777.6	972.0	1166.4	1360.8	1555.2	1749.6	1944.0
<b>38</b>	205.2	410.4	615.6	820.8	1026.0	1231.2	1436.4	1641.6	1846.8	2052.0	
<b>40</b>	216.0	432.0	648.0	864.0	1080.0	1296.0	1512.0	1728.0	1944.0	2160.0	
*BMP VOLUME PROVIDED IN CF = (TRENCH CROSS-SECTION AREA IN SF) * (TRENCH LENGTH IN FT) * 0.36											
**ASSUMES VOID RATIO OF STONE IN TRENCH IS 36%											

Table T9-107.C

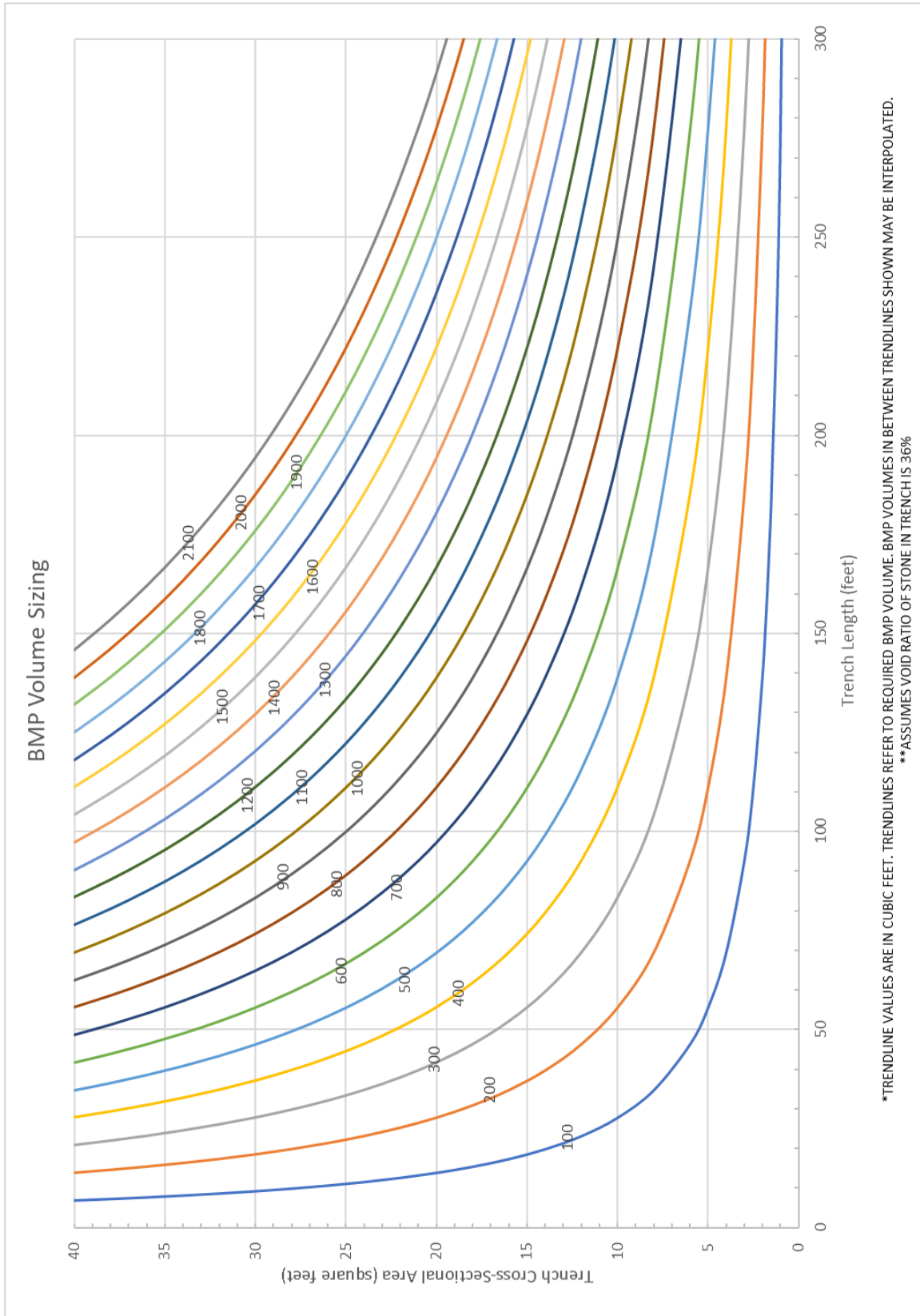

Pollutants of Concern

The applicant is required to identify pollutants of concern that are likely to be generated by the proposed development. Identifying the pollutants will allow the applicant to determine the water quality treatment required for the project and the best management practices that would meet this requirement. Examples of pollutants of concern and their typical sources are provided below.

Table T9-107.D

<b>Pollutant</b>	<b>Sources</b>
Solids (suspended sediment, floatables, dissolved chloride, sulfates)	Litter, road runoff, soil erosion from construction, streambanks, croplands, and untreated sites, cleared vegetation, human & animal waste, vehicle fuels & fluids, vehicle wear, industrial/household chemicals, industrial processes, pool waters discharged improperly, road salt used for de-icing, snow runoff
Biochemical Oxygen Demand	Decaying vegetation, excessive growth of vegetation, soil erosion, human & animal waste, vehicle fuels & fluids, vehicle wear, industrial/household chemicals, industrial processes, pesticides
Metals (Cadmium, Chromium, Copper, Iron, Lead, Mercury, Nickel, Silver, Zinc)	Road runoff, tire wear, wear of clutch and brake linings, soil erosion, human & animal waste, vehicle fuels & fluids, vehicle wear, industrial/household chemicals, industrial processes, paints, pesticides
Pathogens (bacteria, fecal coliform)	Septic tank overflows/leaks/failures, illicit discharge from sanitary sewers into storm sewers, sanitary sewer overflows, untreated or inadequately treated sewage, animal waste
Oil (oil, grease, fuels, lubricants)	Industrial spills, runoff from streets, gas stations, & parking lots, improper disposal of used oil into storm drains, business districts, shopping centers, office parks, vehicle fuels & fluids, fuel combustion, industrial/household chemicals, industrial processes, paints
Nutrients (Nitrogen, Phosphorus, Nitrates)	Agriculture, improper composting and yard waste disposal, septic tanks, soil erosion, cleared vegetation, fertilizers, animal waste, fuel combustion, industrial/household chemicals,



	industrial processes, atmospheric deposition onto impervious surfaces that become runoff
Herbicides, Pesticides, Insecticides	Improper or excessive use of lawn chemicals, agriculture

Infiltration-based BMP Restrictions

In order to protect groundwater resources from contamination due to stormwater runoff pollutants, certain situations are restricted from providing infiltration BMPs. Those situations are discussed in the Ordinance.

The Illinois State Geological Survey database of water wells can be accessed here: <http://maps.isgs.illinois.edu/ILWATER/>

The Illinois State Water Survey database of water wells can be accessed here: <https://www.isws.illinois.edu/data/gwdb/>

The Illinois Environmental Protection Agency database of water wells can be accessed here: <http://illinois-epa.maps.arcgis.com/apps/webappviewer/index.html?id=4d37a05f5ba441f1b30dab54ccb81fc8>

The NRCS Web Soil Survey may be utilized to determine the classification of soils on the site and generally in the location of the BMP. This database can be accessed here: <https://websoilsurvey.sc.egov.usda.gov/App/HomePage.htm>.

The Administrator may also require that soil borings be provided to verify the soil classification.

Example Developments & Redevelopments

Table 9-107 of the Ordinance has been provided on the following page. Examples for each row of the table and are provided on the pages following the Table T9-107.E.

T9-107.E

Development Category	New Impervious Area for Development or Net New Impervious Area for Redevelopment	Stormwater Mitigation / BMP		Fee-in-Lieu <sup>2</sup> (Section)
		Category I (Section)	Category II (Section)	
Development or Redevelopment	< 5,000 sq.ft <b>See Example T9-107.A.1</b>	X <sup>1</sup> (9-107.C)		A (9-85)
	5,000 sq.ft. – 24,999 sq.ft. <b>See Example T9-107.A.2</b>	X (9-107.C)		A (9-85)
	≥ 25,000 sq.ft. AND < 1% Site area <b>See Example T9-108.A.1</b>		X (9-107.D)	A (9-85)
	≥ 25,000 sq.ft. AND ≥ 1% Site area <b>See Example T9-107.A.3</b>		X (9-107.D)	A (9-85)
Linear Project (Trails/Roads)	> 1-acre in aggregate for roads and trails that are ≤ AASHTO max. width	X (9-107.C)		A (9-85)
	> 1-acre in aggregate for roads and trails that are > AASHTO max. width <b>See Example T9-107.A.4</b>		X (9-107.D)	A (9-85)
Total Impervious Area > 50% Site area (for Sites < 1-acre) <b>See Example T9-107.A.5</b>		X (9-107.C)		A (9-85)
Hydrologically Disturbed Area > 3-acres			X (9-107.D)	A (9-85)
X = Required; A = Allowed				

<sup>1</sup>Required at the discretion of the **Administrator** where known flooding or drainage issues are in the immediate vicinity of the project, in areas without **Adequate Downstream Stormwater Capacity**, or that outlet to a **Volume Sensitive Watershed**.

<sup>2</sup>Fee-in-lieu requires approval of the **Administrator** and compliance with the requirement listed under Subsection 9-81.B.4.

### Example T9-107.A.1

Development of an undisturbed 0.5 acre (21,780 sq. ft.) Site is proposed with a 3,500 sq. ft. house and 1,000 sq. ft. driveway with a total of 4,500 sq. ft. of New Impervious Area. Drainage issues are in the immediate vicinity of the project.

#### Existing Site:

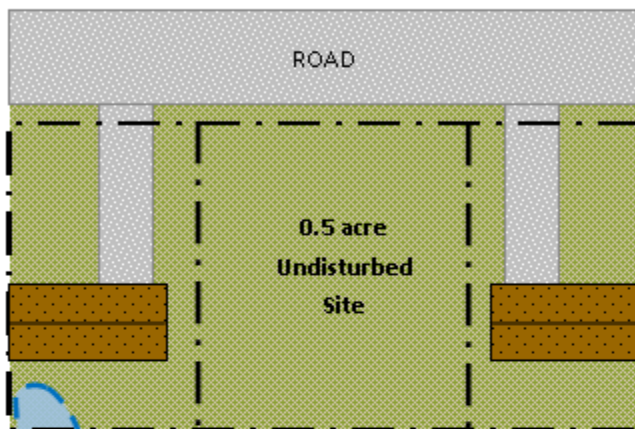

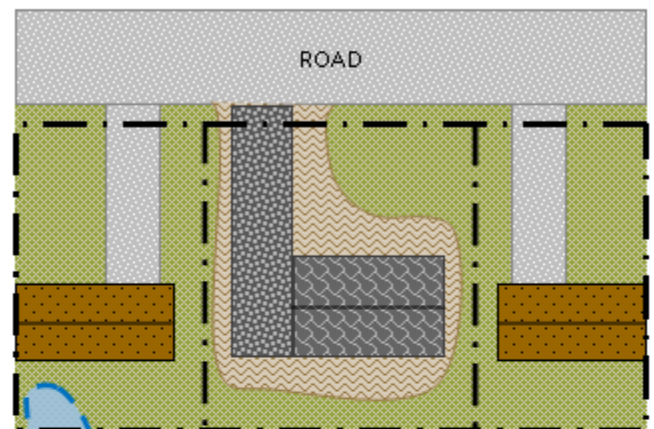

#### Proposed Site:



 Existing Undisturbed (not a Hydrologically Disturbed Area) = 0.5 acre (21,780 sq. ft.)

 Existing Impervious = 0 sq. ft.

 Proposed Pervious (Hydrologically Disturbed Area) = 0.25 acre

 New Impervious Area (Hydrologically Disturbed Area) = 4,500 sq. ft.

 Poor Drainage Area

Total Impervious Area =  $4,500 / 21,780 = 0.20 * 100 = 20\%$  of Site area

Detention Required = No, <25,000 sq. ft. New Impervious Area

Stormwater Mitigation/BMP = No, less than 5,000 sq. ft. of New Impervious Area

No, < 50% Total Impervious Area on Site < 1 acre

Yes<sup>2</sup>, drainage issue is in the immediate vicinity of the project.

<sup>2</sup> Required at the discretion of the **Administrator** where known flooding or drainage issues are in the immediate vicinity of the project, in areas without **Adequate Downstream Stormwater Capacity**, or that outlet to a **Volume Sensitive Watershed**.

**Stormwater Mitigation/BMP Volume and Sizing:**

$$V_{BMP} = 1in \times NI_{HDA}$$

$$1in \times \frac{1ft}{12in} \times 4,500ft^2 = 373.5ft^3$$

The table below can also be used instead of the formula.

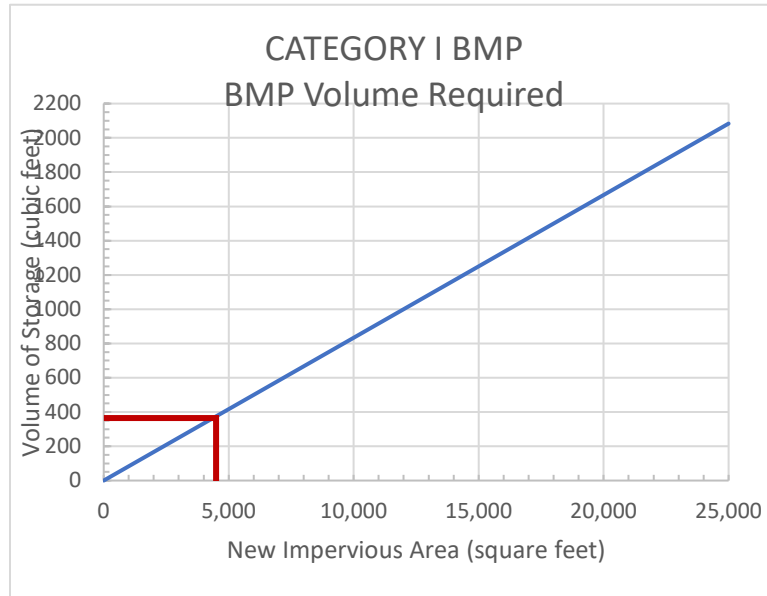

The Cross-Sectional Area and length can then be determined using the table below.

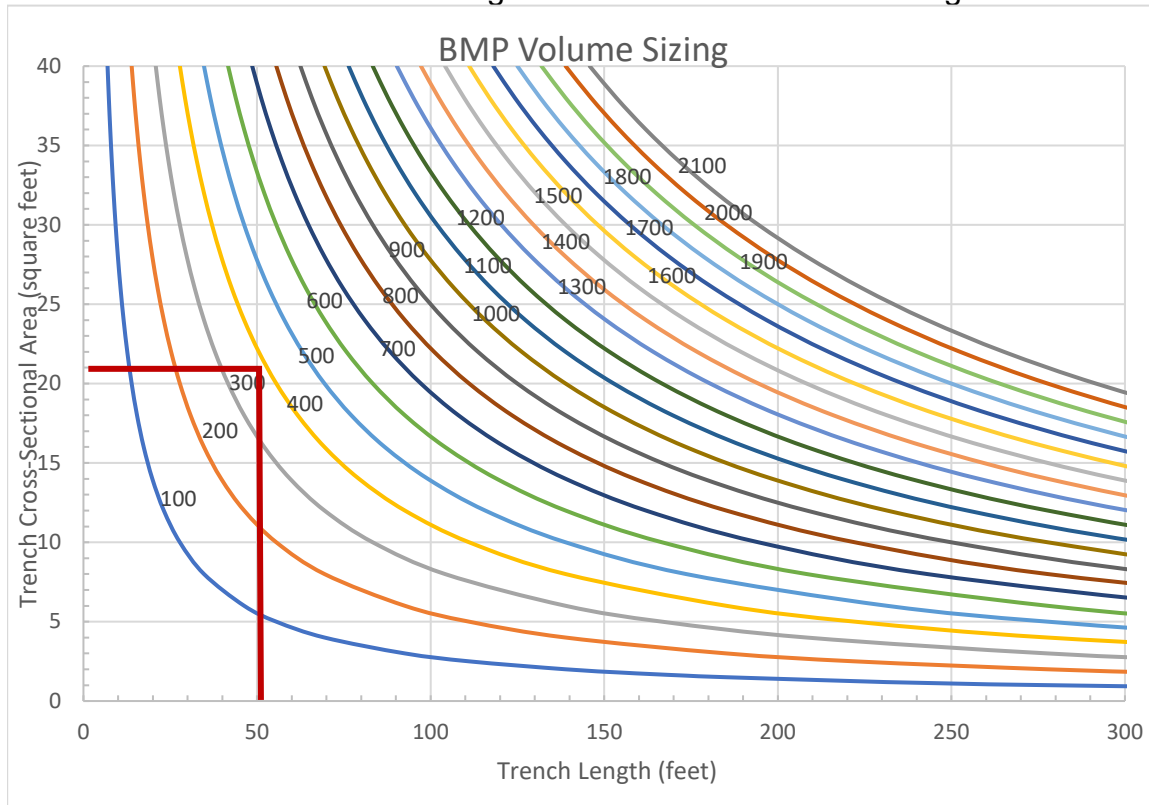

The resulting BMP size for this example is 50 feet in length with a cross sectional area of 21 feet.

*Example T9-107.A.2*



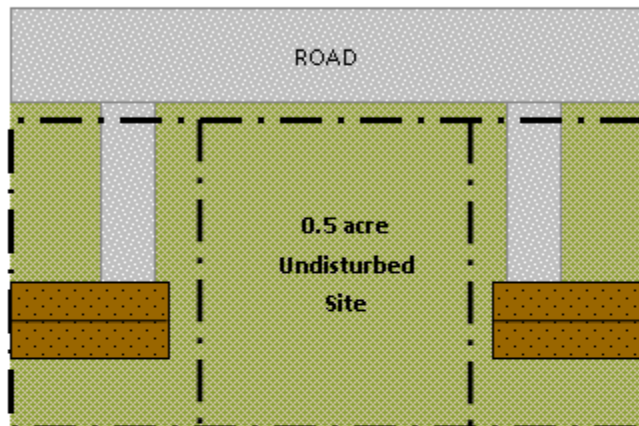

Development of an undisturbed 0.5 acre (21,780 sq. ft.) Single Family Residential Site is proposed with a 5,000 sq. ft. home and 3,500 sq. ft. driveway/patio with a total of 8,500 sq. ft. of proposed New Impervious Area.

Existing Site:

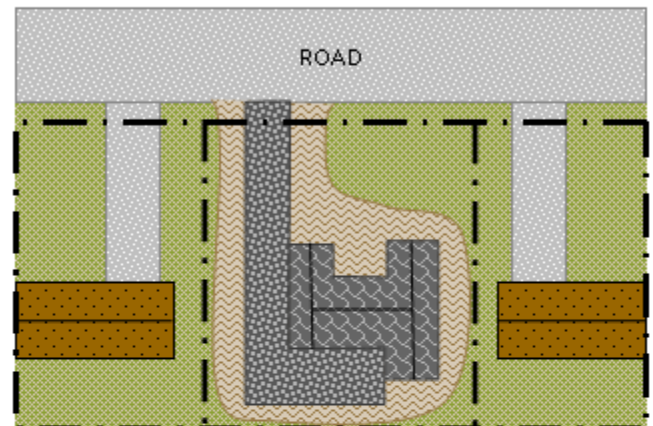

Proposed Site:



-  Existing Undisturbed (not a Hydrologically Disturbed Area) = 0.5 acre (21,780 sq. ft.)
-  Existing Impervious = 0 sq. ft.
-  Proposed Pervious (Hydrologically Disturbed Area) = 0.25 acre
-  New Impervious Area (Hydrologically Disturbed Area) = 8,500 sq. ft.

Total Impervious Area =  $8,500 / 21,780 = 0.39 * 100 = 39\%$  of Site area

Detention Required = No, < 25,000 sq. ft. New Impervious Area

Stormwater Mitigation/BMP = Yes, New Impervious Area > 5,000 sq. ft.

**Stormwater Mitigation/BMP Volume and Sizing:**

$$V_{BMP} = 1in \times NI_{HDA}$$

$$1in \times \frac{1ft}{12in} \times 8,500ft^2 = 705.5ft^3$$

The developer calculates the Volume of the BMP using the formula and determines the Cross-Sectional Area and length using the table below. The lot is 80 feet wide, so the Developer chooses a BMP with a 75 foot in length and a cross sectional area of 26 feet.

**BMP Volume Sizing (cubic feet)**

		Trench Length (feet)									
		15	30	45	60	75	90	105	120	135	150
Trench Cross-Sectional Area (square feet)	2	10.8	21.6	32.4	43.2	54.0	64.8	75.6	86.4	97.2	108.0
	4	21.6	43.2	64.8	86.4	108.0	129.6	151.2	172.8	194.4	216.0
	6	32.4	64.8	97.2	129.6	162.0	194.4	226.8	259.2	291.6	324.0
	8	43.2	86.4	129.6	172.8	216.0	259.2	302.4	345.6	388.8	432.0
	10	54.0	108.0	162.0	216.0	270.0	324.0	378.0	432.0	486.0	540.0
	12	64.8	129.6	194.4	259.2	324.0	388.8	453.6	518.4	583.2	648.0
	14	75.6	151.2	226.8	302.4	378.0	453.6	529.2	604.8	680.4	756.0
	16	86.4	172.8	259.2	345.6	432.0	518.4	604.8	691.2	777.6	864.0
	18	97.2	194.4	291.6	388.8	486.0	583.2	680.4	777.6	874.8	972.0
	20	108.0	216.0	324.0	432.0	540.0	648.0	756.0	864.0	972.0	1080.0
	22	118.8	237.6	356.4	475.2	594.0	712.8	831.6	950.4	1069.2	1188.0
	24	129.6	259.2	388.8	518.4	648.0	777.6	907.2	1036.8	1166.4	1296.0
	26	140.4	280.8	421.2	561.6	702.0	842.4	982.8	1123.2	1263.6	1404.0
	28	151.2	302.4	453.6	604.8	756.0	907.2	1058.4	1209.6	1360.8	1512.0
	30	162.0	324.0	486.0	648.0	810.0	972.0	1134.0	1296.0	1458.0	1620.0
	32	172.8	345.6	518.4	691.2	864.0	1036.8	1209.6	1382.4	1555.2	1728.0
	34	183.6	367.2	550.8	734.4	918.0	1101.6	1285.2	1468.8	1652.4	1836.0
	36	194.4	388.8	583.2	777.6	972.0	1166.4	1360.8	1555.2	1749.6	1944.0
	38	205.2	410.4	615.6	820.8	1026.0	1231.2	1436.4	1641.6	1846.8	2052.0
	40	216.0	432.0	648.0	864.0	1080.0	1296.0	1512.0	1728.0	1944.0	2160.0

\*BMP VOLUME PROVIDED IN CF = (TRENCH CROSS-SECTION AREA IN SF) \* (TRENCH LENGTH IN FT) \* 0.36

\*\*ASSUMES VOID RATIO OF STONE IN TRENCH IS 36%

**Example T9-107.A.3**

Development of an undisturbed 5 acre Site is proposed with a commercial warehouse and a parking lot resulting in 2 acres of New Impervious Area and 1 acre of pervious Hydrologically Disturbed Area.

Existing Site:

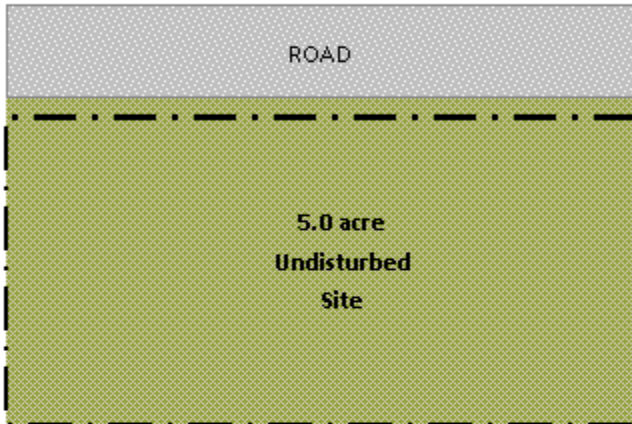

Proposed Site:

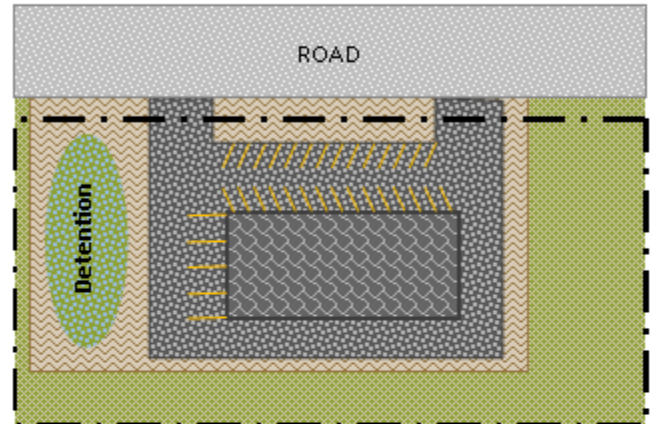

- Existing Undisturbed (not a Hydrologically Disturbed Area) = 5.0 acres
- Existing Impervious = 0 sq. ft.
- Proposed Pervious (Hydrologically Disturbed Area) = 1.0 acre
- New Impervious Area (Hydrologically Disturbed Area) = 2.0 acres

Total Impervious Area =  $2 / 5 = 0.4 * 100 = 40\%$  of Site area

Detention Required = Yes > 25,000 sq. ft. New Impervious Area and greater than 1% of the Site area

Stormwater Mitigation/BMP = Yes, New Impervious Area > 5,000 sq. ft. and greater than 1% of the Site area

Stormwater Mitigation/BMP Volume:

$$V_{BMP} = 1in \times NI_{HDA}$$

$$1in \times \frac{1ft}{12in} \times 87,120ft^2 = 7,230.96ft^3$$

Given that a large Volume is required the developer chooses to provide the BMP Volume in the detention storage facility.

*Example T9-107.A.4*



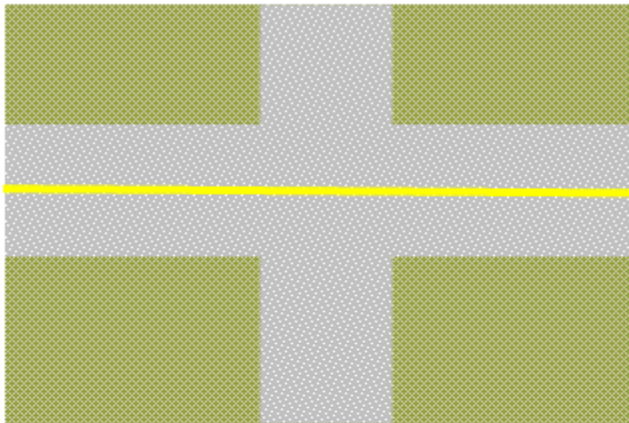

An existing public roadway is being widened to accommodate a 3,630 linear foot 12' wide middle turn lane and shoulder widening. The New Impervious Area exceeds 1 acre in aggregate.

Existing Site:

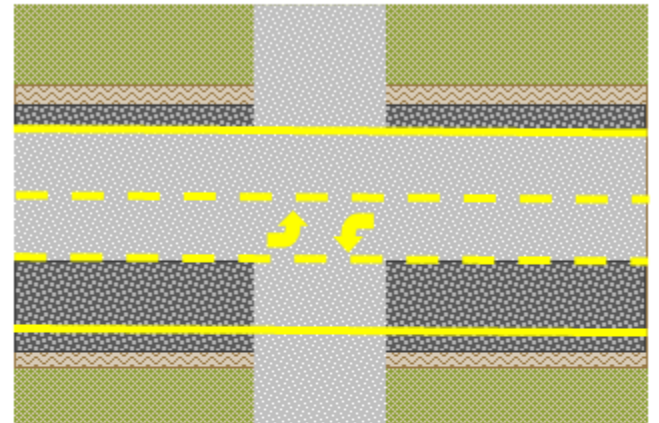

Proposed Site:



-  Existing Undisturbed (not a Hydrologically Disturbed Area) = 3.0 acres
-  Existing Impervious = 2.0 acres (87,120 sq. ft.)
-  Proposed Pervious (Hydrologically Disturbed Area) = 0.5 acre
-  New Impervious Area (Hydrologically Disturbed Area) = 1.5 acres (65,340sq. ft.)

Total Impervious Area = N/A  
 Detention Required = Yes, Net New Impervious Area > 1 acre in aggregate  
 Stormwater Mitigation/BMP = Yes, Net New Impervious Area > 1 acre in aggregate



Stormwater Mitigation/BMP Volume:

As the overall roadway width is greater than the AASHTO Guide for Development of Bicycle Facilities maximum width, the development will require a Category II Stormwater Mitigation/BMP design. The developer explores the first option for calculating Category II BMP volume:

$$V_{BMP} = 1in \times NI_{HDA}$$

$$1in \times \frac{1ft}{12in} \times 65,340ft^2 = 5,445.00ft^3$$

Given that a large Volume is required, the developer chooses to explore the second option for calculating BMP volume, utilizing the Average Annual Rainfall and the RECARGA program. The developer first calculates the pre-development infiltration volume. A facility area of one (1) square foot is utilized in order to have the program run properly.

**RECARGA Version 2.3**  
Bioretention/Raingarden Sizing Program

Units: English

**Planview Data**

- Facility Area: 1 [sf]
- Tributary Area: 5.0 [acre]
- Percent Impervious: 40.0
- Pervious CN: 78

**Files**

- Regional Ave. ET: 0.13 [in./day]
- Simulation Type: Continuous
- Input File Length: 266 days
- Precip. File Name: Med1981us
- Output File Name: Pre-Development
- Summary  Record

**Facility Inputs**

Soil Texture	Infiltration Rate [in/hr]	Depth [in.]
Depression		12
Root Layer		
Sandy Loam	3.94	24
Storage Layer		
Sand	5.91	12
Native Soil Layer		
Silt Loam	.13	

**Underdrain**

- Flowrate: 0 [in./hr]
- Diam.: 0 [in.]

**Target Stay-on**: 0 [in.]

**Facility Area Ratio (%)**: Edit Text [%]

**Results**

**Plant Survivability**  
(Less than 48 hours max. ponding is desirable)

	max.	Total
Hrs. Ponded	397.5	2907.75
Number of overflows		38

**Tributary Runoff** [in]

- Precipitation: 28.81
- Impervious Runoff: 20.8212
- Pervious Runoff: 4.1033

**Raingarden Water Balance**

	[in.]	%
Runon	10.7905	37.4541
Runoff	10.7882	37.4462
Recharge	0.002139	0.007426
Evaporation	9.0679e-	0.000314
Underdrain	0	0
Soil Moisture	1.3256e-	4.6013e-
Stay-on	18.021	62.5538

Developed by the University of Wisconsin-Madison  
Civil & Environmental Engineering Water Resources Group  
(D. Atchison, A. Dussailiant, L. Severson)

## Stormwater Mitigation/BMP Volume (cont'd):

The “Stay-on” depth listed in the lower right-hand corner of the interface refers to the total depth of water retained on the site (infiltrated) in the pre-development conditions (18.021 inches). This number can be converted into a pre-development volume by multiplying by the overall site area. However, as the site area will always be the same in the pre-development and post-development conditions, the depth may be compared instead.

The developer is required to match ninety percent (90%) of the pre-development infiltration volume in the post-development conditions. Therefore, the post-development infiltration volume (in this case, depth) is calculated as follows:

$$\text{Minimum Required PostDevelopment Infiltrated Rainfall Depth} = 0.9 * 18.021 \text{ in} = 16.219 \text{ in}$$

The developer then remodels the site under post-development conditions. The design of the rain garden is modified until the minimum required post-development infiltration depth (“Stay-on”) is met.

**RECARGA Version 2.3**  
Bioretention/Raingarden Sizing Program

Units: English

### Facility Inputs

Soil Texture	Infiltration Rate [in/hr]	Depth [in.]
Depression		12
Root Layer		
Sandy Loam	3.94	24
Storage Layer		
Sand	5.91	12
Underdrain	Flowrate: 0 [in/hr]	Diam.: 0 [in.]
Native Soil Layer		
Silt Loam	.13	

Target Stay-on: 0 [in.]  
Facility Area Ratio (%): Edit Text [%]  
Run FAR

### Planview Data

Facility Area: 1550 [sf]  
Tributary Area: 5.0 [acre]  
Percent Impervious: 70.0  
Pervious CN: 78

### Files

Regional Ave. ET: 0.13 [in./day]  
Simulation Type: Continuous  
Input File Length: 266 days  
Precip. File Name: Mad1981.us  
Output File Name: Post-Development  
Summary Record

### Results

**Plant Survivability**  
(Less than 48 hours max. ponding is desirable)

	max.	Total
Hrs. Ponded	238.5	2462.25
Number of overflows		26

**Tributary Runoff** [in.]

Precipitation: 28.81  
Impervious Runoff: 20.8212  
Pervious Runoff: 4.1033

**Raingarden Water Balance**

	[in.]	%
Runon	15.8413	54.9853
Runoff	12.5776	43.6572
Recharge	3.0324	10.5255
Evaporation	0.15198	0.52752
Underdrain	0	0
Soil Moisture	0.020402	0.070817
Stay-on	16.232	56.3428

RUN SIMULATION  
CLEAR RESULTS

Developed by the University of Wisconsin-Madison  
Civil & Environmental Engineering Water Resources Group  
(D. Atchison, A. Dussailiant, L. Severson)

**Example T9-107.A.5**

Redevelopment of a 0.9 acre (39,204 sq. ft.) Site is proposed. The Site has an existing 8,500 sq. ft. small office building and parking lot. The building will be demolished and rebuilt in the same location with an additional 3,350 sq. ft. footprint within an area that is currently undisturbed pervious.

Existing Site:

Proposed Site:

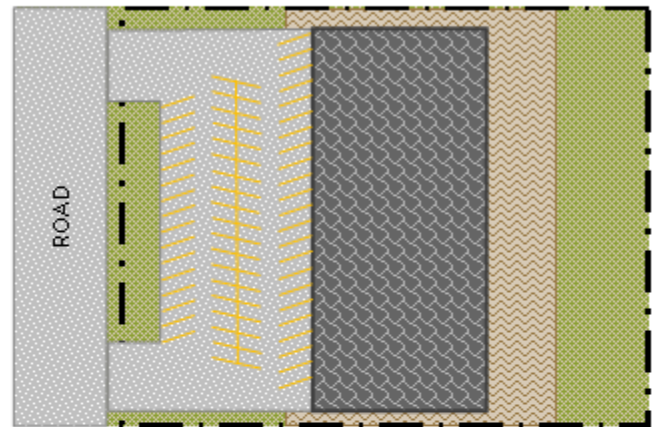
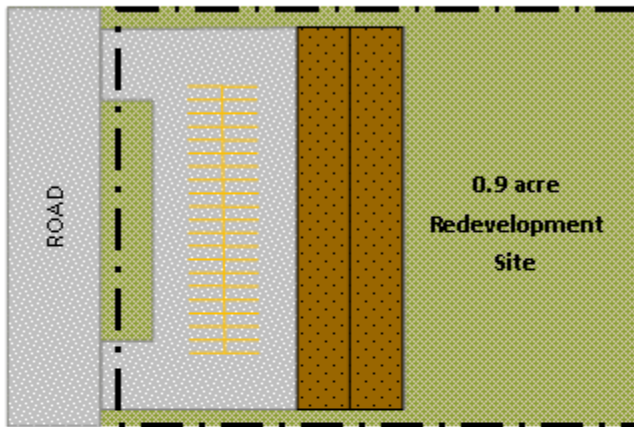

 Existing Undisturbed (not a Hydrologically Disturbed Area) = 0.5 acre (21,780 sq. ft.)

 Existing Impervious = 0.4 acre (17,424 sq. ft.)

 Proposed Pervious (Hydrologically Disturbed Area) = 0.2 acre

 New Impervious Area (Hydrologically Disturbed Area) = 11,850 sq. ft.

Net New Impervious Area (Hydrologically Disturbed) =  
 (New Impervious Area - Existing Impervious Area Removed)  
 20,778 - 17,424 = 3,350 sq. ft.

Total Impervious Area =  $20,778 / 39,204 = 0.52 * 100 = 52\%$  of Site area

Detention Required = No, <25,000 sq. ft. New Impervious Area

Stormwater Mitigation/BMP = No, Net New Impervious area < 5,000 sq. ft.

Yes, Total Impervious Area is > 50% of the Site for Sites < 1 acre

**Stormwater Mitigation/BMP Volume and Sizing:**

$$V_{BMP} = 1in \times NI_{HDA}$$

$$1in \times \frac{1ft}{12in} \times 11,850ft^2 = 983.55ft^3$$

The table below can also be used instead of the formula.

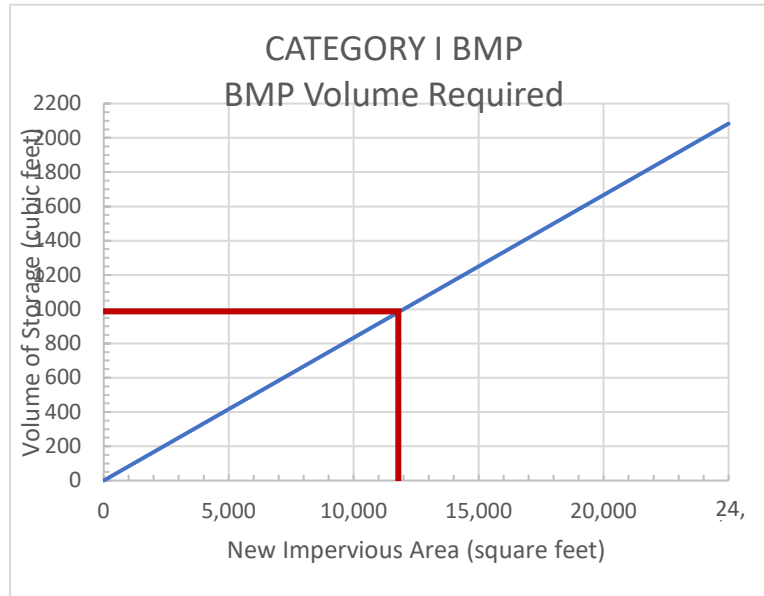

The Cross-Sectional Area and length can then be determined using the table below.

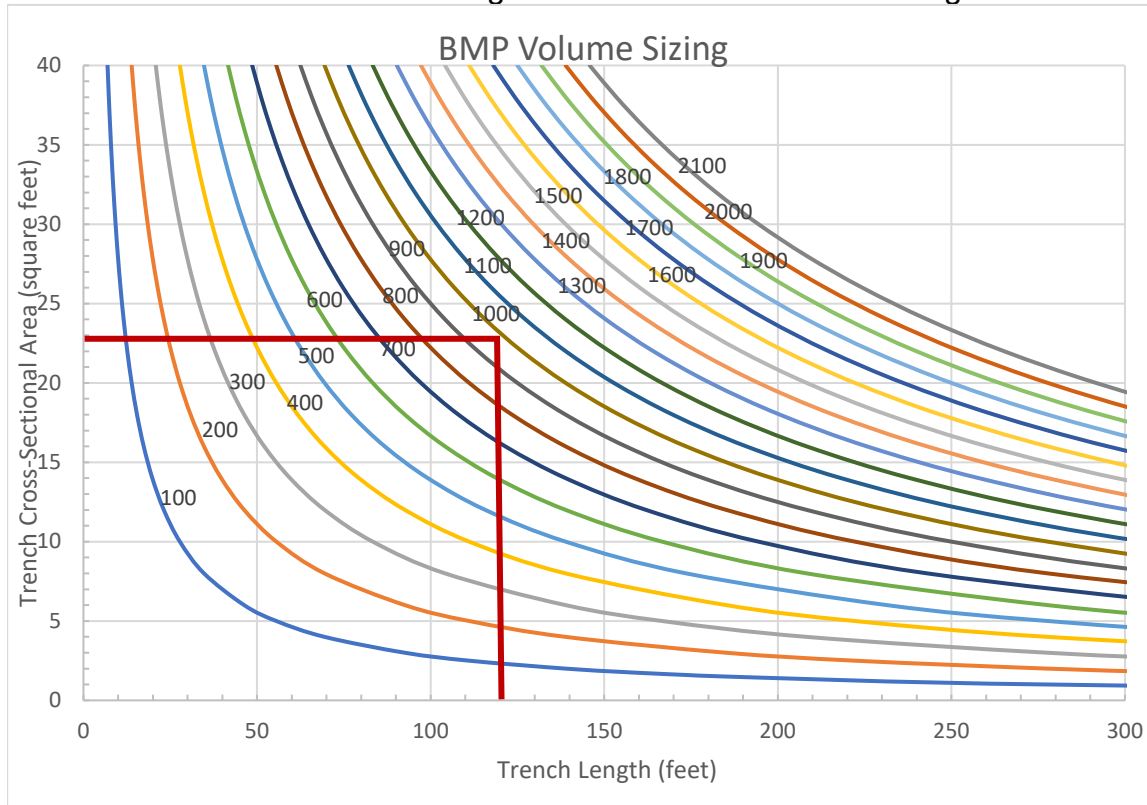

The resulting BMP size for this example is 120 feet in length with a cross sectional area of 23 feet.

## Example Best Management Practices

### *Introduction*

This section provides guidance on a number of stormwater BMPs that can be used to meet the Kane County Volume Reduction standard. The BMPs outlined in this Chapter include:

1. Permeable Interlocking Concrete Pavements
2. Rain Gardens
3. Infiltration Trenches
4. Level Spreader and Filter Strips
5. Naturalized Stormwater Basins

Guidance for each of these BMPs is provided in subsequent sections of this chapter. For each of the BMPs, the following are provided.

1. Design guidance: Describes site suitability, design parameters, hydrologic analysis, and sizing.
2. Example specification: Written specifications that can be used within construction documents.
3. Standard detail: A standard detail that may be used within construction drawings or inform the production of construction drawings.

The Technical Guidance Manual is not an exhaustive list of BMPs that can be used to provide a water quality and quantity benefits. Each practice will need to be evaluated on a case by case basis. Appropriate documentation should be provided to insure the proposed practice will function as designed.

The guidance in this manual does not relieve the designer of responsibility for meeting all federal, state, and local requirements.

### Infiltration-Based BMPs:

Infiltration refers to the introduction of runoff water into the underlying soil. Infiltration facilities typically provide temporary storage to allow slow infiltration of runoff water from a particular size event.

In relation to stormwater, retention is the opposite of surface discharge. With retention, runoff water does not leave the site and is instead infiltrated, evaporated, or reused within the site. Although there may be storage associated with retention facilities, the runoff water is not permanently stored on the site. Retention strategies mimic the natural water cycle and release runoff back to the environment as groundwater recharge or evaporation or both but not as surface runoff. Reuse of collected rainwater for later irrigation or grey water reuse could also be considered a retention strategy. Although there may be storage associated with retention facilities, the runoff water is not

permanently stored on the site. The Kane County requirement that one inch (1.0”) of runoff over the new impervious area be retained is a retention standard.

Wet detention basins are often referred to as retention basins. However, because the permanent pool is ever-present, the only retention is the small amount of drawdown that may occur between events due to evaporation or mild infiltration.

The Best Management Practices outlined in this chapter are all at least partially retention practices. While many of these practices can be designed to retain most any volume of runoff, the design guidance provided here is specifically targeted to meeting the 1.0-inch retention standard.

Storage Based:

Storage Based BMPs temporarily store runoff water within soil or vegetation for later evaporation. With a Storage Based BMPs, the stored water is used by the vegetation and evaporated or transpired but not infiltrated. Examples of Storage Based BMPs include rain gardens located on impervious soils and green roofs.

Pre-treatment BMPs:

Bioinfiltration is a special class of retention BMP. Bioinfiltration facilities temporarily store runoff water for infiltration.

<b>BMP</b>	<b>Detention</b>	<b>Infiltration</b>	<b>Storage Based</b>	<b>Pre-Treatment</b>
Detention Storage Facility	X			
Dry Well		X		
Infiltration Trench		X		
Permeable Pavement	X	X		
Green Roof	X		X	
Rain Garden/Bioinfiltration		X	X	X
Hydrodynamic Separators				X
Vegetated Swale/Bioswale		X	X	X
Filter Strip				X

## Classification of Typical Stormwater BMPs

### **Combination Facilities:**

Many BMPs do not fall into only one category, as evidenced in the above table. For example, permeable pavement systems are both detention and infiltration. These systems temporarily store runoff water in the aggregate below the paving surface. Some of that water infiltrates into the subgrade and some is slowly drained (and therefore detained) by an edge drain that discharges to the surface or to a sewer system.

As can be seen in the table, there are many BMPs that fall into the categories of infiltration and storage based, such as rain gardens and bioswales. Rain gardens are shallow depressions lined with amended topsoil that are often underlain with a gravel storage/drainage layer. Bioswales are essentially the same as rain gardens except they tend to be long and linear and sometimes provide conveyance as well as storage. Because bioswales often provide both retention in the topsoil and infiltration through the bottom, the term bioswale is conveniently used rather than the more limiting terms of bioinfiltration swale and bioretention swale.

Although guidance for green roofs is not included in this document, a green roof is a bioretention BMP. A green roof (or vegetated roof) does not provide infiltration but can retain significant runoff. Rain water that falls onto the engineered green roof soil hydrates the soil where the water is retained for later evaporation and transpiration by plants. Most green roofs are capable of retaining 1.0-inches and more of runoff. Thus, with approval from the enforcement officer, green roofs can be assumed to meet the Kane County 1.0-inch retention standard.

### BMP Systems:

Although it is convenient to discuss individual BMPs, it is best to design stormwater management systems to provide necessary retention, conveyance, and detention. It is also best to distribute those systems throughout a site (decentralization of the stormwater treatment system) rather than using the more typical end-of-pipe approach to mitigating stormwater runoff. With a decentralized system, no one facility or one location of the site must manage all of the runoff and therefore greater volumes of retention are possible to better mimic natural hydrology. The Blackberry Creek Alternative Futures Analysis report:

<http://foxriverecosystem.org/WatershedPlanning/Blackberry/PlanI/BBCAF-ReportSummary.pdf>

provides example BMP systems for various development types and densities and documents potential site and watershed scale benefits of implementing decentralized, retention based stormwater management systems.

**Guidance Organization:**

Although a systems approach is recommended, this guidance is organized by BMP for purposes of providing design guidance and specifications. Each BMP section provides guidance on suitable applications, limitations to their use, site data requirements, hydrologic design criteria and sizing guidance, guidance on vegetation selection and establishment, construction considerations, and maintenance and operation requirements. Sample construction details and specifications are also provided for each BMP.





## Permeable Interlocking Concrete Pavements

### **Definition and Examples:**

Permeable interlocking concrete pavement represents one type of porous pavement. These pavers are pre-cast units that have openings or large crevices (expanded joints) formed into them. The crevices (or expanded joints) are created through tabs or spacers that are cast onto the concrete unit block paver. The cast-on tabs or spacers lock into each other to create a flexible pavement system. Simple openings in the paver unit are provided by removing or adding a section from/to the cast.

The width and size of the crevices or opening in the interlocking pavers varies by the products and yields different ratios of openings per square foot. The crevices are filled with an open graded permeable material to allow water to infiltrate through the pavement. The gradation and permeability of this material will ultimately determine the rate at which water can be infiltrated through the porous paver surface.

Porous pavers can be combined with other BMPs in this guidance manual. Biofiltration measures, such as rain gardens with or without infiltration trenches, can be used in parking lot islands to treat and convey runoff that may be discharged from the porous pavement surface during very intense rainfalls. Small rain gardens can be used at the downstream end of porous pavements to treat and infiltrate surplus runoff that may be generated.

Other porous pavement options, although not addressed in this manual, are porous asphalt and porous cast-in-place concrete.

### **Suitable Applications**

Porous pavers are an important structural BMP tool and valuable alternative to conventional pavements. Their application is ideal for small sites where surface detention is not feasible due to space constraints. Porous pavement systems may further be used on sites with high permeability soils where there is no drainage system to accept pavement runoff. They can be integrated into new developments and can be retrofitted into existing developments. Suitable areas or development types in which porous pavements can be incorporated are:

1. Paths, sidewalks, and walkways
2. Patios, terraces, and plazas
3. Driveways
4. Parking lots
5. Main and service drives
6. Emergency access areas
7. Small subdivision roads and alleyways
8. Non-commercial boat ramps and landings

### **Benefits**

The purpose and concept behind porous unit block pavers is to offer a decentralized stormwater management tool. It provides retention and detention. The former allows for stormwater infiltration through the pavement wearing course, its base, and into the subgrade. It thus can be used to meet the 1.0-inch retention standard. Depending on the subgrade infiltration rates, use of permeable pavement can help to maintain the natural water cycle, recharging local aquifers and supporting groundwater driven base flows in streams and other water bodies. Permeable pavement systems can also improve water quality through filtration and a reduction in runoff temperatures<sup>1</sup>.

**Ancillary benefits:**

1. Increased longevity when compared to conventional asphalt and concrete pavements<sup>2</sup>
2. Can reduce downstream detention needs
3. Efficient land use through combination of stormwater management and vehicular infrastructure
4. Can increase aesthetic value of the property
5. Can reduce the need for costly stormwater infrastructure

**Limitations**

1. It is recommended that the contributing watershed not exceed 20% of the area of the porous pavement installation<sup>3</sup>.
2. The drain time for porous pavements should be limited to approximately 24-hours<sup>4</sup> to ensure the structural integrity of the pavement subgrade. Where soil permeability is insufficient and/or the volume of runoff is too great, a lateral subsurface drain must be installed to meet the 24-hour drainage requirement.
3. Porous pavement systems must provide adequate separation above the seasonal high ground water table and should be located at least 10-feet down slope and 100-feet up slope from building foundations unless adequate waterproofing is provided and direct drainage to footing drains can be prevented<sup>5</sup>.
4. Soils on bed rock with very high infiltration rates may be unsuitable for porous pavement installations. Infiltration under such conditions may lead to sink holes and potential groundwater contamination.
5. Highly expansive clay soils are unsuitable for porous pavement installation<sup>6</sup> unless adequate drainage is provided to prevent saturation of the expansive subgrade soils. An appropriate drainage system is necessary to collect and dispose of excess stormwater in a controlled manner. However, if the drainage causes the stone storage volume to drawdown in less than one (1) day, the system may not receive BMP volume credit for the practice.
6. Unless the system is lined, use of porous pavers is not recommended over contaminated soils and in areas with land uses such as:
  - a. Gas stations, recycling facilities, salvaging yards, vehicle storage, service and cleaning facilities and other uses with risk of stormwater coming into contact with hazardous materials.

- b. Land uses where there is storage of agricultural contaminants (e.g. pesticides, fertilizers, sediments) that could come into contact with stormwater.
  - c. Commercial marina services where there is a risk of fuel or other spills.
  - d. Outdoor loading and storage facilities where hazardous materials are being managed.
  - e. Well fields.
  - f. Land uses within the recharge zone of sensitive wetlands, such as fens and other areas where the impact of potential increased volumes of groundwater recharge could be detrimental unless the amount of infiltration is controlled.
  - g. Locations where construction site runoff (that could clog the system) and other risks of sedimentation cannot be controlled.
7. Interlocking paver systems are not suitable for roadways that exceed the Average Daily Traffic (ADT) of 2000 and the speed limit of 30 miles/hour (i.e. collector roads, arterial roads, freeways).

### **Required Design Data**

#### **Infiltration capacity / suitability of subgrades:**

The infiltration capacity of the subsoils under the porous pavement will determine the volume of runoff that can be exfiltrated from the pavement base/subbase into the ground over a given time. The infiltration capacity, along with the contributing watershed and subgrade strength will help to determine the drainage and structural design for the porous pavement.

The Kane County Soil Survey provides some guidance with regards to soil permeability and subgrade strength. It is, however, recommended to commission a soil report with density test reports and classification. The report should further include results of a hydraulic conductivity test performed at the location and elevation of the proposed bottom of the pavement to establish the site-specific permeability rate (double ring infiltrometer test per ASTM D3385, lab test per ASTM D2434 through a Shelby tube sample, or have a Certified Professional Soil Classifier conduct an on-site soil investigation to determine soil suitability or a Falling Head Percolation Test (described in Forms & Reference Documents).

#### **Seasonal high water table:**

If the site in question for the porous pavement is known to have a relatively high water table, data on the elevation of the seasonal high water table is needed. The bottom of the porous pavement should be at least three feet above the seasonal high water table<sup>7</sup> to reduce the potential for shallow ground water contamination.

#### **Contributing drainage area:**

Along with the infiltration capacity, the drainage area and level of imperviousness contributing to the porous pavement, if any, will determine the drainage design of the

porous pavement. In general, pervious areas should not be drained toward permeable pavement to minimize the risk of sediment clogging.

## **Porous Unit Pavement Design**

### **Porous Unit Pavement Design Principles:**

Permeable interlocking concrete pavements behave as flexible pavements<sup>8</sup>. The surface is composed of tightly placed high-strength concrete pavers. The tight placement in combination with appropriate edge restraint, the laying pattern, and granular fill in the crevices allows the pavers to interact and function as a unified structure rather than individual units. This flexible pavement behavior mandates a flexible pavement design.

Permeable interlocking concrete pavements constitute a high strength, long-lived wearing course set into a setting bed. The purpose of the setting bed is to provide an accurate leveling course that allows the paver to be set at the specified elevations. The base and subbase course are the major load-carrying element. They distribute the loads to the level where it can be tolerated by the subgrade without failure. An additional function of the subbase in porous pavement systems is to laterally drain the water that is infiltrated through the pavement surface as well as store water temporarily to allow additional time for infiltration and/or to provide detention. It should also perform as a capillary barrier. This prevents water from moving upwards into the pavement base. It helps to secure the pavement's structural integrity and prevents ice lenses from forming in the pavement. The subbase may be followed by a layer of improved or stabilized subgrade if the structural properties of the soil prove insufficient.

Design for porous paving has to reconcile structural and drainage objectives. To assure structural integrity of the pavement and prevent frost heave damage, a properly designed subbase with the appropriate drainage characteristics is of critical importance<sup>9</sup>. Good pavement design for porous unit pavers results in water infiltration and particle filtration combined with structural strength.

### **Load Bearing Strength:**

The subgrade strength is a dominant factor in flexible pavement design<sup>10</sup>. Soil, or subgrade strength, is sometimes expressed by the Modulus of Elasticity (E), but more typically by the California Bearing Ratio (CBR) as defined in the ASTM D 1883 specification. The CBR of soils, particularly those that are finer graded, varies with moisture content. This is important in porous pavement design, where the subgrade is expected to be wet. Soils with permeability lower than 0.8-inch/hour can be used for exfiltration as long as the subgrade remains stable while saturated. The saturated subgrade CBR in porous pavement must be at least 5% after a minimum of 96-hours of soaking if used for vehicular traffic<sup>11</sup>. Other empirical design specifications require a 6,550 psi Modulus of Elasticity in porous pavement design<sup>12</sup>, which translates into 4.3% CBR for relatively soft, fine grained soils<sup>13</sup>.

Most subgrades will require some compaction or other stabilization treatment to assure sufficient load bearing capacity. This may greatly reduce or eliminate the infiltration capacity on finer graded soils. In some instances, the use of a geotextile can help to balance structural with infiltration objectives. The use of a woven-monofilament geotextile will spread loads over a wider area and allows for bridging of weak spots in the subgrade. An increase in depth of the base or subbase is an alternative to the use of a geotextile. The increased depth of base or subbase spreads the load over a larger area. By using these methods, the need for compaction on finer graded soils can be reduced or eliminated to preserve infiltration rates. It is recommended to consult a geotechnical engineer to evaluate soils for their CBR and suitability under porous pavements.

#### Seasonal high water table:

On installations where the main objective is to exfiltrate stormwater into the ground, the bottom of the full-depth pavement must be a minimum of two feet (2') above the seasonal high groundwater table. This distance provides a filter to remove pollutants from the runoff and to prevent shallow ground water contamination.

Staying a minimum required distance above the seasonal high ground water table also has a structural rationale. It prevents groundwater from entering into the pavement and allows for efficient subsurface drainage and exfiltration during storm events. Controlling the moisture content of the subgrade allows for improved load bearing capacity and reduces the potential for frost heave.

#### Well field set back:

Porous pavement systems should not be used in the immediate proximity of a well or a well field. The Ordinance requires a minimum setback of one-hundred feet (100') from known private water supply wells and four-hundred feet (400') from community water supply wells.

#### Freezing conditions and frost depth:

The depth of frost penetration is an important factor in porous pavement design on soils with high silt content. Footing and foundation design frost depth is typically specified by local code (generally 42-inches in Kane County). A porous pavement base does not need to extend to the design frost depth. Silty soils, however, should be adequately drained before frost penetrates through the pavement to minimize the potential for frost heave. Frost heave in porous pavement is, however, not necessarily a failure-causing factor. The unit block pavement system is able to withstand modest amounts of frost heave without damage because of its flexible nature.

#### Edge restraint:

A rigid, stationary edge restraint is of critical importance to permeable interlocking concrete pavements due to the modular nature of the block system. The edge restraint prevents lateral creep, holds the pavers tightly together, and provides load transfer between blocks. Modular pavements without an edge restraint will move laterally, fail

along the edges and cease to provide load transfer between blocks, which compromises the structural integrity of the pavement.

Methods of edge restraint include abutting existing structures, cast-in-place concrete curbs (see also Figure 34) or slabs, pre-cast concrete curbs, or soldier courses set into concrete (see also Figure 45). Recommended minimum dimensions for edge restraints are 6-inches wide and 12-inches deep<sup>14</sup>. The more structurally sound the edge (i.e. concrete products with stable footer and/or concrete haunch), the less the opportunity for pavement failure at the edges. No matter what edge restraint is used, it must remain stationary under stress or it is of no value to the porous block pavement system.

#### Traffic:

Porous pavement applications are suitable for traffic volumes up to those defined in the 'local road' category (ADT 2000 or less) and where the posted speed limit does not exceed 30 miles/hour. Typical examples for the 'local road' category are alleyways and small subdivision roads. The foremost rationale behind the 'local road' restriction is concerns over stormwater runoff quality and pollution. It also attempts to reduce the most common cause of pavement failure, which are heavy, repetitive loads. The occasional school bus, garbage truck, or fire engine represents an acceptable load at acceptable repetitions.

#### Typical cross sections:

Table 12, Table 23, Table 34, and Table 45 show recommended cross section designs for different interlocking porous paver applications. Porous pavement installations on subgrades with an infiltration capacity less than 0.1-inch/hour should be designed and evaluated by a qualified civil engineer.

The indicated depths of the subbase in Table 12, Table 23, Table 34, and Table 45 may be increased if additional storage and detention of runoff is required, or if low subgrade strength requires additional subbase structure. The indicated infiltration rates must be based on the subgrade at the depth of the subbase-subgrade interface after compaction or soil treatment. It is highly recommended that a qualified civil engineer with porous paving experience be consulted if conditions vary from those represented below.

Paths and patios

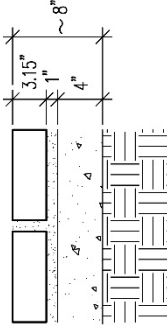
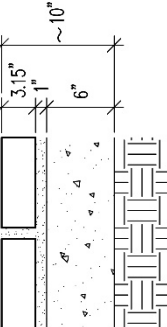
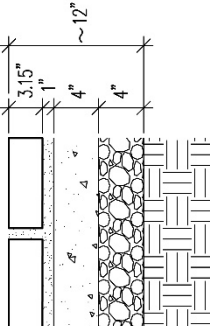
Table 1 Cross section design for <b>PATHS</b> and <b>PATIOS</b> (pedestrian and bicycle applications)			
	Subgrade infiltration rate (after compaction or soil treatment) >8.0-inches/hour	Subgrade infiltration rate (after compaction or soil treatment) from 8.0- to 0.8-inches/hour	Subgrade infiltration rate (after compaction or soil treatment) from 0.8- to 0.1-inches/hour
Block	3.15-inches	3.15-inches	3.15-inches
Setting	1-inch	1-inch	1-inch
Base	4-inches	6-inches	4-inches
Subbase	n/a	n/a	4-inches
Total	~ 8-inches	~ 10-inches	~ 12-inches
			
Drainage	No drainage required	No drainage required	Allow for pavement base to drain within 24-hours, may require drainage at pavement edge)

Driveways and small parking

Table 2 Cross section design for <b>DRIVEWAYS</b> and <b>SMALL PARKING</b> (personal automobiles)			
	Subgrade infiltration rate (after compaction or soil treatment) >8.0-inches/hour	Subgrade infiltration rate (after compaction or soil treatment) from 8.0- to 0.8-inches/hour	Subgrade infiltration rate (after compaction or soil treatment) from 0.8- to 0.1-inches/hour
Block	3.15-inches	3.15-inches	3.15-inches
Setting	1-inch	1-inch	1-inch
Base	6-inches	4-inches	6-inches
Subbase	n/a	6-inches	8-inches
Total	~ 10-inches	~ 14-inches	~ 18-inches
Drainage	No drainage required	Allow for pavement base to drain within 24-hours, may require drainage at pavement edge	Allow for pavement base to drain within 24-hours, may require drainage at pavement edge
CBR = California Bearing Ratio in % (soaked) E = Modulus of Elasticity (in psi) on soaked subgrade for relatively soft, fine grained soils			



Large parking

Table 3 Cross section design for <b>LARGE PARKING</b> (personal automobiles and some truck and bus traffic)			
	Subgrade infiltration rate (after compaction or soil treatment) >8.0-inches/hour	Subgrade infiltration rate (after compaction or soil treatment) from 8.0- to 0.8-inches/hour	Subgrade infiltration rate (after compaction or soil treatment) from 0.8- to 0.1-inches/hour
Block	3.15-inches	3.15-inches	3.15-inches
Setting	1-inch	1-inch	1-inch
Base	8-inches	6-inches	8-inches
Subbase	n/a	6-inches	10-inches
Total	~ 12-inches	~ 16-inches	~ 22-inches
Drainage	No drainage required	Allow for pavement base to drain within 24-hours, include drainage at pavement edge	Allow for pavement base to drain within 24-hours, include drainage at pavement edge
CBR = California Bearing Ratio in % (soaked) E = Modulus of Elasticity (in psi) on soaked subgrade for relatively soft, fine grained soils			

Local Roads

Table 4 Cross section design for LOCAL ROADS			
	Subgrade infiltration rate (after compaction or soil treatment) >8.0-inches/hour	Subgrade infiltration rate (after compaction or soil treatment) from 8.0- to 0.8-inches/hour	Subgrade infiltration rate (after compaction or soil treatment) from 0.8- to 0.1-inches/hour
Block	3.15-inches	3.15-inches	3.15-inches
Setting	1-inch	1-inch	1-inch
Base	10-inches	8-inches	8-inches
Subbase	n/a	8-inches	14-inches
Total	~ 14-inches	~ 20-inches	~ 26-inches
Drainage	No drainage required	Allow for pavement base to drain within 24-hours, include drainage at pavement edge	Allow for pavement base to drain within 24-hours, include drainage at pavement edge
CBR = California Bearing Ratio in % (soaked) E = Modulus of Elasticity (in psi) on soaked subgrade for relatively soft, fine grained soils			

Material/aggregate selection, function and performance:

A porous unit block paver system must be designed and constructed with open graded materials in the paver crevices or openings, the bedding layer, the base, and subbase to ensure and sustain good drainage and infiltration characteristics.

Typical road construction aggregates (including sharp sands) are unsuitable due to their percentage of fines (Sieve No. 16 to 200). These aggregates have small voids and tend to trap fine dust particles that wash into the pavement. This will lead to clogging and formation of an impervious “pan” over time. Infiltrated runoff will accumulate on the pan, which compromises the stormwater objectives of the porous pavement. A reduction in permeability in the base or subbase will also compromise structural objectives. Trapped water in the base can cause high pore-water pressure and result in pumping under dynamic traffic loads<sup>15</sup>. Only non-plastic, open-graded aggregates (plasticity index of 0) that sustain their strength in the presence of water should be used in porous pavement installations<sup>16</sup>.

Open-graded materials for porous pavements should originate from a hard, durable crushed rock with 90% fractured face and a Los Angeles (LA) Abrasion of <40. A design CBR of 80% is recommended<sup>17</sup>.

Crevice fill:

An IDOT CA16 (or ASTM C33 No. 8) crushed stone should be used to fill the paver openings and crevices. The IDOT CA16 is also commonly referred to as 3/8-inch stone chips. The size and porosity of this material allows accumulated dust particles to flush out during heavier storm events. This helps to prevent clogging and sustain good infiltration rates over time. The infiltration rate of the IDOT CA16 should be at least 1,000-inches/hour<sup>18</sup>. Because the crevice fill material is much finer than the base and subbase materials, the crevice material also creates a design failure point in a readily remediated location. The crevice fill material will clog rather than pass material that could clog the base or subbase

Bedding layer:

Besides filling the paver openings and crevices, the IDOT CA16 (or ASTM C33 No. 8) crushed stone should be used for the bedding layer. As with the paver openings and crevices, the size and porosity of this material allows accumulated dust particles to flush out during heavier storm events. The infiltration rate of the IDOT CA16 should be at least 1,000-inches/hour<sup>19</sup>.

Base course:

This structural/load bearing component of the pavement should be constructed using an IDOT CA7 (or ASTM C33 No. 57) crushed stone. The infiltration rate of the IDOT CA7 should be at least 1,000-inches/hour<sup>20</sup>.

Subbase course:

This pavement component has several objectives: capillary break, structural support of the pavement, and storage and drainage. The latter is essential, although a drainage rate (hydraulic conductivity) greater than necessary will reduce detention time and amount of runoff infiltrated unless other means are used to slow drainage of this layer. A crushed rock, such as the IDOT CA7 (or ASTM C33 No. 57) or larger rock, such as the IDOT CA1 (or ASTM C33 No. 2) has good porosity and structural characteristics and provides both excellent drainage and an effective capillary barrier.

Filter criteria:

It is of critical importance to specify and use materials that are resistant to migration within the pavement and thus meet filter criteria. Finer-graded materials that wash out (migrate) and erode into underlying coarser graded materials do not meet the filter criteria and lead to settlement and pavement failure. The installation of an IDOT CA16 (bedding layer) over an IDOT CA7 (base course) installed over an IDOT CA1 (subbase course) meets the filter criteria.

If materials are used that differ from the above stated gradations, it is recommended that their filter criteria be verified. The following method is commonly applied in geotechnical analysis<sup>21</sup>:

$$\frac{D_{15}}{d_{85}} \leq 5$$

Another method, recommended by the International Concrete Pavement Institute (ICPI) is as follows<sup>22</sup>:

$$\frac{D_{15}}{d_{50}} < 5 \text{ and } \frac{D_{50}}{d_{50}} > 2$$

Where:

D = coarser aggregate (open graded stone)

d = finer aggregate (choke stone)

A coarse, open-graded subbase placed over a subgrade of fine material may not meet the filter criteria. In this case, subgrade material can migrate up into the subbase, choking it and leading to failure. Wet subgrade (expected in porous pavement systems) in combination with dynamic traffic loads (causing vibration) can lead to pumping, which compromises the structural performance of the pavement.

Pumping can be prevented and the filter criteria met by placing an appropriate geotextile between the subbase and subgrade. Both woven monofilament and non-woven, needle-punched fabrics will provide an adequate filter. Woven monofilament fabrics may be less subject to blinding than non-woven, needle-punch fabrics. Further, woven monofilament fabrics generally have lower elongation than non-woven

products and therefore provide superior bridging capability. However, many woven fabrics have relatively low permittivity and it is therefore critical that a high permittivity (>1.2/sec) be specified (see Section **Error! Reference source not found.**). Standard woven (tape) filter fabrics should not be used as they are insufficiently permeable and do not pass sufficient volumes of water.

Aggregates must be kept clean and protected from soil contamination throughout the construction process. This is to preserve their porosity and drainage characteristics. All installed porous block paver systems must be protected from siltation during and during construction. Eroding soils that wash onto the pavement will clog the crevices and effectively eliminate the infiltration capacity of the paver surface.

Surface drainage design:

Runoff onto the porous paver surface from the contributing drainage area must be free of sediment, such as construction site runoff to prevent clogging of the crevices and loss of infiltration capacity. This requires thorough erosion control throughout the installation process, including the re-establishment of the vegetation on disturbed soils in the contributing drainage area. Porous pavements should be designed and installed in a manner that eliminates or reduces the risk of erosion contamination for the life of the pavement.

The porous unit block pavement in itself is a drainage tool since it transmits water through the pavement surface. The infiltration capacity of the pavement surface is not determined by the percentage of openings, rather it is determined by the infiltration capacity of the crevice fill material since runoff water is routed to the openings by the paver surface. That fill material must be open-graded with no or a limited amount of fines. Use of the proper fill material will sustain a good infiltration capacity and surface drainage over the lifetime of the pavement and reduce or eliminate the need for catch basins and other drainage structures.

Data on the infiltration capacity through the pavement surface of permeable interlocking concrete pavements further shows that 2.5-inches/hour is a conservative design infiltration capacity for mature systems. It is, however, imperative that the open-graded materials meet the specifications. A significantly more conservative approach recommends the use of a surface infiltration capacity of 1-inch/hour over a 20-year life for porous pavements<sup>23</sup>. This design infiltration capacity though is based on data from infiltration trenches and therefore may not be applicable to permeable pavement surfaces. One research project on pavement systems found that surface infiltration capacity of interlocking concrete paver systems was restored to near full capacity through remedial maintenance<sup>24</sup>.

As with most pavements, it is recommended that the porous unit block pavers be installed with at least 1% slope<sup>25</sup>. Because a properly installed porous pavement will only generate surface runoff during very heavy storms, conventional catch basin and stormwater pipe installations can be reduced in number, substituted by vegetated swales or eliminated all-together<sup>26</sup>. The use of vegetated swales instead of catch

basins reduces costs relative to conventional drainage infrastructure. Vegetated swales have the added advantage of treating and filtering the surface runoff. Provisions for frequent curb cuts should be made if the pavement edge is a raised curb. These curb cuts can be as frequent as one for every parking stall; this frequency allows any excess surface water to drain into adjacent vegetated swales with nominal energy dissipation such as a splash pad or small amount of stone. For large flow rates through the curb cuts, larger stone material, level spreaders, or inflow chambers may be necessary.

#### Subsurface drainage:

The subsurface drainage design of porous pavements is largely determined by the infiltration capacity of the subgrade soils. A porous pavement installation can tolerate temporary storage of runoff in the base and subbase without compromising its structural integrity. Maintaining structural integrity under periodic wet conditions is contingent on subgrade strength, sufficient base and subbase depth, and the use of appropriate aggregates and geotextiles<sup>27</sup>. The stored runoff will ultimately be exfiltrated into the ground or collected and discharged through a drainage system. Porous pavements on freely draining soils with an infiltration capacity that equals or exceeds 8.0-inch/hour and have adequate depth to groundwater do not require any additional drainage infrastructure. The soil permeability should be measured at the proposed depth of the subgrade and under compacted conditions.

The same also applies to paths, patios, driveways and small parking installations on soils with infiltration capacities between 8.0- and 0.8-inches/hour. However, it is important to ensure that water in the pavement base is drained within sufficient time to prevent weakening of the subgrade soils. Pavements designed based on the California Bearing Ratio (CBR) should be designed to drain within 72 hours to not exceed the conditions under which CBR testing is conducted.<sup>28</sup> (see also Table 12 and Table 23). A geotechnical engineer should be consulted if a drainage time longer than 72-hours is required. Under no circumstances should the maximum ponding time under the pavement exceed 72-hours to ensure that the volume is available for subsequent events and to avoid sealing of the subgrade soils due to growth of biological slimes. To meet these drainage requirements, subsurface drainage may be necessary in many cases. For large parking lots and local roads, the same standard applies and, at a minimum, subsurface drainage should be provided at the pavement edge (see also Table 34 and Table 45). This requires that the subgrade of the installation is graded with a minimum of 1% slope towards the pavement edge.

Soils with an infiltration rate of 0.8- to 0.1-inch/hour may exhibit a reduction in their structural capacity when saturated for extended periods. The pavement base of paths, patios, driveways, and small parking installed on such soils should drain within 72-hours (see also Table 12 and Table 23). To meet the 72-hour requirement, subsurface drainage will be necessary in most cases, particularly at the low end of the permeability range. The same 72-hour drain time applies to porous pavement on large parking lots and local road installations. The traffic load on the latter two further necessitates subsurface drainage at the pavement edge (see also Table 34 and Table

45), which requires that the subgrade of the installation is graded with a minimum of 1% slope towards the edge and other locations of subsurface drainage.

Where drainage is required, adequately sized perforated pipe should be used to ensure drainage within 72-hours. In most cases 4-inch pipe will be adequate. The openings should be sufficiently small to prevent migration of subbase material. No sock should be used as it may clog over time.

To provide detention within the pavement subbase and base, the perforated pipe may be fitted with an orifice(s) to control the rate of drainage. Provided that there is no surface inlet to the drain, very small orifices may be used since there is no access for debris that could clog the orifice. Nevertheless, cleanouts should be provided at all orifice locations. Cleanouts should also be provided at both ends of each drain and at all significant changes in direction.

**Building foundation and basements:**

Porous pavement installations should be a minimum of 10-feet down slope from building foundations and 100-feet upslope unless adequate waterproofing is provided and direct drainage to footing drains can be prevented. Another rule that can be applied to protect building basements is to set back the porous pavement 1.5 times the distance of the building foundation depth<sup>29</sup>.

**Monitoring well:**

A monitoring well should be installed with the system, which will provide for access to bottom of system for observation for rate of exfiltration. The monitoring well also is used to take water samples to permit runoff water quality analysis.

## **Construction Considerations**

**Excavation:**

Unless the pavement can be protected from all construction site runoff, the excavation of the porous pavement area should be scheduled after the completion of other site work, such as all other earthwork, landscaping operations, and other heavy construction<sup>30</sup>. This is to prevent soil compaction and clogging of the porous pavement system or contamination of the porous pavement aggregates. It is recommended to use methods and means during final excavation of the porous pavement base that minimizes soil compaction and thus preserves the infiltration capacity of the natural soils.

**Soil erosion and sediment control:**

Runoff from the contributing watershed must be free of sediment, such as construction site runoff to prevent clogging of the subgrade, base, or crevices and loss of infiltration capacity. This requires thorough erosion control throughout the installation process, including the re-establishment of the vegetation on disturbed soils in the contributing watershed. Porous pavements should be designed and installed in a manner that eliminates or reduces the risk of erosion contamination for the life of the pavement. It

is further recommended to limit the runoff from the contributing watershed onto the porous pavement.

Soil erosion and sediment control practices should be maintained and inspected on a regular basis. Accumulated sediments within on-lot sediment traps and along silt fences should be promptly removed. All disturbed areas shall be promptly stabilized and compromised erosion and sediment control devices should be promptly repaired.

Stockpiles should be located downstream of the porous pavement; if unable to do so, stockpiles shall have a double row of silt fence that surrounds the perimeter of the stockpile.

Before the porous pavement goes online, the contributing drainage area (if any beyond the surface of the pavement) must be stabilized/fully vegetated.

Aggregate installation principles:

Woven monofilament or non-woven, needle-punched fabrics should be placed over the subgrade to provide an adequate filter and prevent soil migration and pumping. Standard woven (tape) filter fabrics should not be used as they are insufficiently permeable and do not pass sufficient volumes of water.

The open graded subbase and base course must be installed in lifts that do not exceed 12-inches to assure sufficient compaction. Compaction equipment should be approved by the project engineer. Depending on the size of the installation, a Steel Drum Compactor (min. 60-inch drum) or Vibratory Plate Compactor (min. 42-inch plate), both capable of controlled frequency, can be used. Full particle interlock of the open-graded material must be achieved, which requires three passes with an approved compactor. More than three passes may lead to over compaction, which may result in particle abrasion. The process of particle abrasion will add undesired fine matter to the open graded material.

The bedding layer is typically not compacted until after the paver installation. A plate compactor with 3000 to 5000 lbs of centrifugal compaction force that operates at 80-90 Hz should be used across the installed pavement<sup>31</sup>. This operation sets the pavers firmly into place and also compacts the underlying bedding layer.

## **Operation and Maintenance**

It is recommended that permeable interlocking concrete pavements be inspected on an annual basis, preferably in spring after a major rain storm to verify that the stormwater is infiltrating into the system. Areas that have pooled water standing on the surface need to be addressed through remedial maintenance as opposed to routine maintenance. A monitoring well should be installed with the system to provide for access to the bottom of the system for observation for rate of exfiltration. The monitoring may also could be used to take water samples to permit runoff quality analysis.



#### Routine maintenance:

It is imperative that permeable interlocking concrete pavements be designed and installed in a manner that eliminates or reduces the risk of sedimentation and erosion contamination for the life of the pavement. If the permeable pavement is connected to a contributing watershed (i.e. other pavements or lawn areas) it should be monitored on an annual basis to ensure that runoff from these sources is not depositing sediments and debris on the porous pavement. Areas near construction traffic, agricultural land (no ground cover), and areas subject to high winds that will carry fine particles will require more frequent monitoring and sweeping.

#### Sweeping:

Routine maintenance involves normal street sweeping, similar to that used on standard asphalt and concrete paving. While high efficiency vacuum sweepers are more effective at capturing and removing fine sediment than mechanical broom sweepers, mechanical sweeper equipment is sufficient to dislodge surface encrusted sediment. Permeable paving surfaces should be dry-swept (water should be turned off) in dry weather to remove encrusted sediment that appears as small curled “potato chips”. When vacuum equipment is used, vacuum settings should be adjusted to prevent uptake of aggregate from the pavement openings and joints. Sweeping porous pavements once a year (preferably in spring) is normal; if excessive silts and fines are present, additional monitoring of the surface to determine silt build-up and additional sweeping may be needed (i.e. late fall and spring) to remove accumulated debris.

Closed joint permeable interlocking pavements may be pressure washed if desired. Care should be exercised to keep wand at an angle and away from the surface to prevent abrading and blasting of void material from joints and void openings. It is not recommended to utilize a pressure washer on open-jointed systems.

#### Winter maintenance:

As with any pavement, snow plowing is required after snowstorms. Four season parking surfaces, streets, and plaza areas may be plowed with truck-mounted blades, power brooms, snow-blowers, or manually shoveled. Rubber or nylon, rather than steel, are recommended for the replaceable snowplow tip, if bladed snow plowing equipment is used. However, steel tips are used for plowing many installations, particularly where plowing speeds are low. Manufacturers of permeable interlocking concrete pavements state that the chamfered top edges minimize chipping and allows for normal plowing procedures. Shoes at the edges of the blade and rubber nylon tipped blades are recommended for all pavements to protect the equipment and driver from impact at manholes, pavement joints, etc. that are common to asphalt and poured concrete roads.

Due to the short flow distance from the paver surface to a joint opening, the opportunity for ice formation is greatly reduced. Also, researchers state that the underlying stone bed tends to absorb and retain heat, further reducing ice formation. For these reasons, regular deicing should not be necessary and is not recommended for water

quality protection reasons. However, for occasions when icing does occur, a mild application of deicing salt may be used. If abrasives are necessary, stone chips that are preferably of the same quality and specification as the void material should be used rather than sand. The application of stone chips may require sweeping and removal in the spring. If sand is used, it will tend to clog the openings and lead to the premature need for remedial maintenance.

#### Void filling:

The open graded stone chips in the voids and joints are subject to settling, particularly during the first year after installation. If necessary, additional void materials may be added by manually sweeping into joints and voids. Refer to specifications for type and grade.

#### Remedial maintenance:

Studies have shown a high initial infiltration capacity of permeable interlocking concrete pavements with a decrease and leveling off over time<sup>32</sup>. The decrease in infiltration capacity over time is due to deposition of fine material such as silt, organic debris, and subsequent vegetation in the joint aggregate.

The need for remedial maintenance can be determined by visual inspection. Areas that pond water on the surface will require remedial maintenance. Remediation can be achieved using a vacuum sweeper with water jets, sweeper, and vacuum bar attachment to evacuate clogged joint material. The evacuated joint material can either be washed and replaced or new joint material can be used to refill the joints (refer to specifications for size and grade). Jointing materials are to be swept into joints and voids until full, typically to the bottom of the chamfer. The frequency of required remedial maintenance depends on the degree of sediment and debris loading as well as the level of routine maintenance. Experiences from older installations show, however, that permeable interlocking concrete pavements continue to function many years after installation, which makes remedial maintenance operation more an exception. The need for remedial maintenance is also a function of sediment and erosion control during construction of the site and during the lifetime of the pavement. Proper erosion control will be necessary during construction of the homes and remedial maintenance should be performed after the home sites have been built out.

One research project on pavement systems found that surface infiltration capacity of interlocking concrete paver systems was restored to near full capacity after remedial maintenance<sup>33</sup>.

#### Structural maintenance:

Settlement/ruts in pavement surface, access for utility repair, and removal of broken or damaged pavers may be performed by an experienced paver installer. Pavers should be removed, and the setting bed and void materials can be salvaged and kept separate. Base materials are to be removed if access for utilities is required. Settlement repair depending on depth should be restored with additional base materials if settlement exceeds 0.5-inch. The setting bed should be made level and

pavers re-instated with void materials replaced in the joints and voids with compaction bringing the pavers to flush condition and ready for use.

**Porous Pavement Easement Protection:**

The Ordinance requires that stormwater features (such as the permeable pavement) are protected by an easement (Category II) or Declaration of Restriction and Covenant (Category I). All permeable pavement areas that are part of the submitted and approved stormwater management system thus are required to be in an easement. If the permeable pavement is not part of the stormwater management system, such as a parking stall installed by a homeowner on his or her own accord, it is exempt from the easement requirement.



## Typical Detail

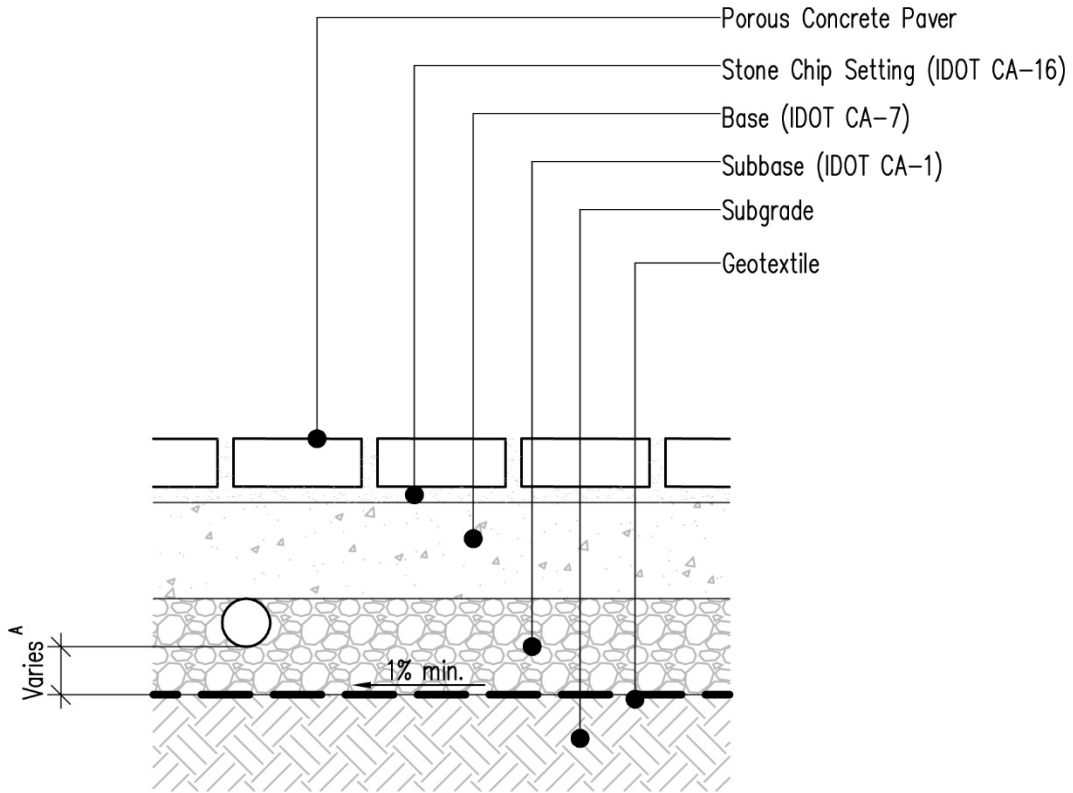

A) Maximum draintime not to exceed 24 hours.

### Notes:

1. Depth of base and subbase varies based on structural requirements and/or detention storage needs.

## Porous Pavement with Retention Cross Section

Not to Scale

Figure 1 – Porous Pavement Detail (with retention storage volume)

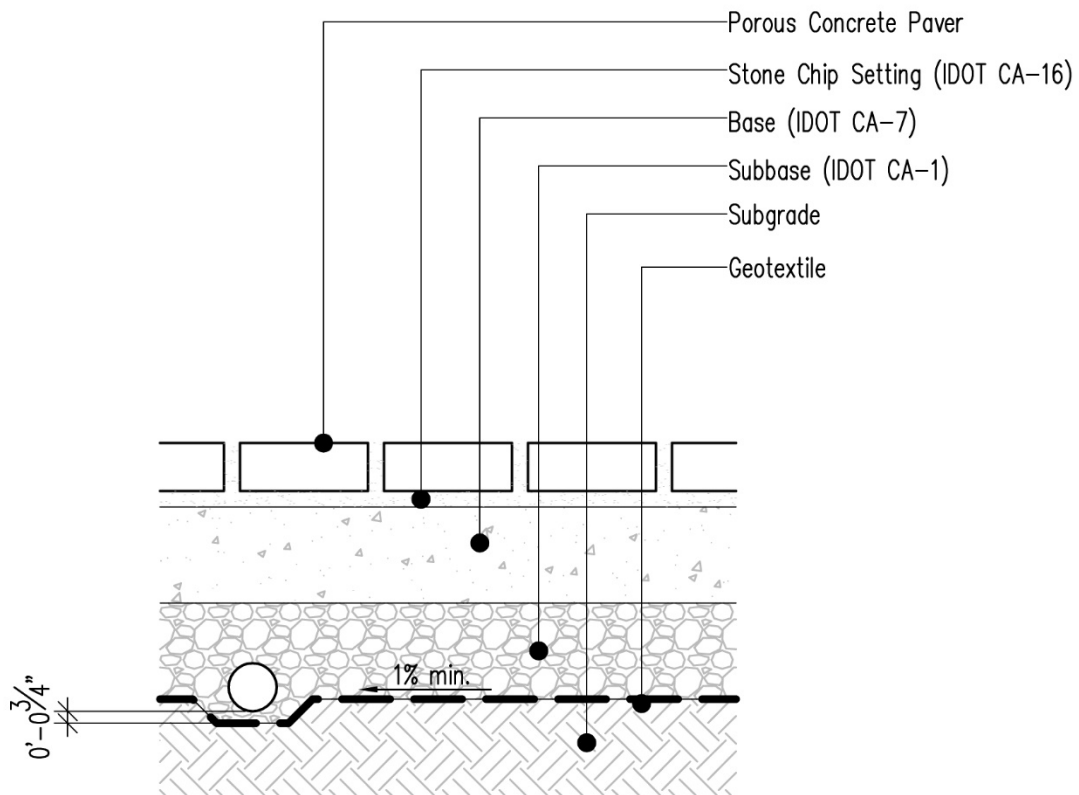

Notes:

1. Depth of base and subbase varies based on structural requirements and/or detention storage needs.

## Porous Pavement Cross Section

Not to Scale

Figure 2 – Porous Pavement Detail (without retention storage volume)

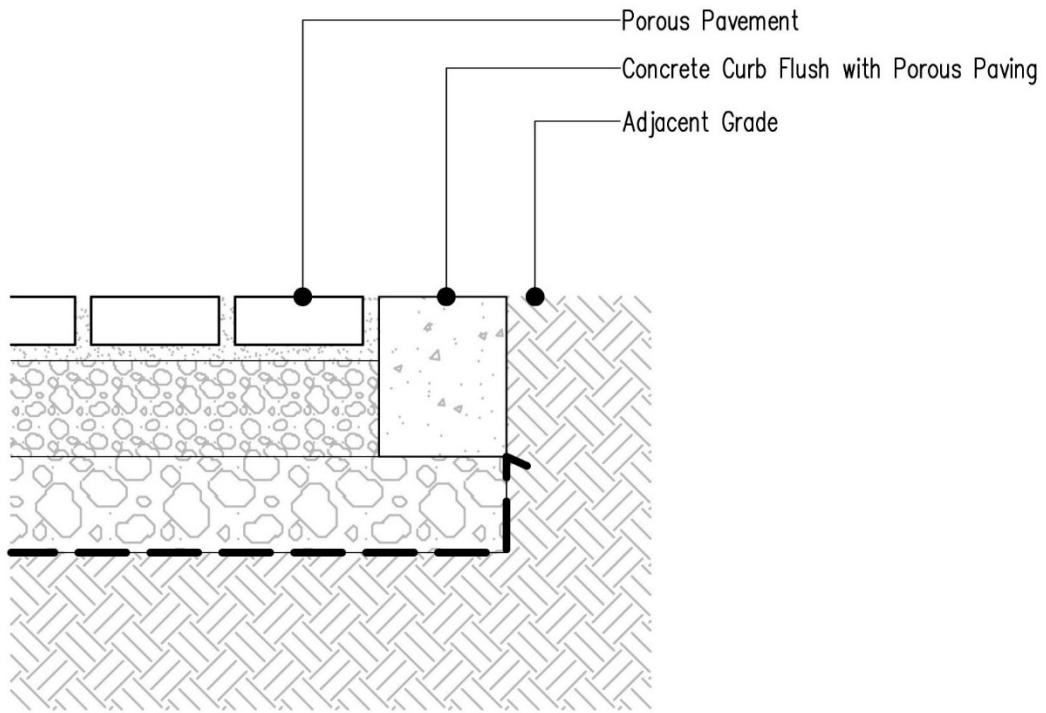

### Flush Concrete Curb

Not to Scale

Figure 3 – Porous pavement edge restraint: Flush Concrete Curb

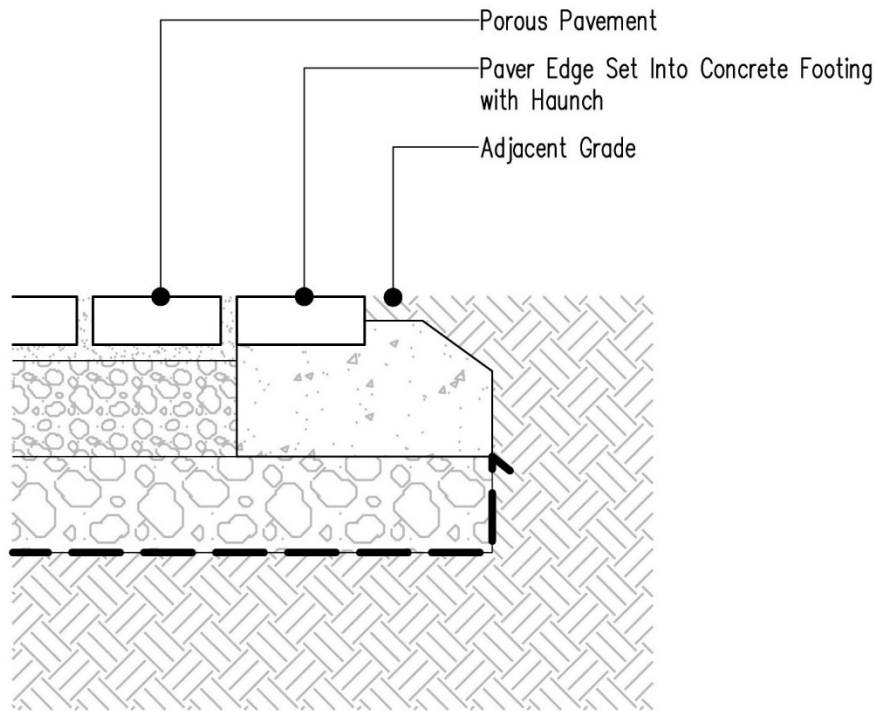

## Concrete Paver Footing

Not to Scale

Figure 4 – Porous pavement edge restraint: Concrete Paver Footing

- <sup>1</sup> Smith (2001); Smith (2003)
- <sup>2</sup> JEGEL (2000)
- <sup>3</sup> Smith (2001); Smith (2003)
- <sup>4</sup> EPA (1999)
- <sup>5</sup> Smith (2001); Smith (2003)
- <sup>6</sup> Rollings *et al.* (1993)
- <sup>7</sup> Schueler (1987); Horner *et al.* (1994); EPA (1998)
- <sup>8</sup> Rollings *et al.* (1992)
- <sup>9</sup> Borgwardt *et al.* (2000); Rollings *et al.* (1992); Yoder *et al.* (1975)
- <sup>10</sup> Rollings *et al.* (1993)
- <sup>11</sup> Smith (2001)
- <sup>12</sup> Borgwardt *et al.* (2000)
- <sup>13</sup> Dorman *et al.* (1964)
- <sup>14</sup> Schueler (1987); Horner *et al.* (1994); EPA (1998)
- <sup>15</sup> Smith (2001)
- <sup>16</sup> Borgwardt *et al.* (2000)
- <sup>17</sup> Rollings *et al.* (1993)
- <sup>18</sup> Smith (2001)
- <sup>19</sup> Smith (2001)
- <sup>20</sup> Smith (2001)
- <sup>21</sup> Smith (2001)
- <sup>22</sup> Dunn *et al.* (1980); Rollings *et al.* (1992); Borgwardt *et al.* (2000)
- <sup>23</sup> Smith (2001)
- <sup>24</sup> Brattebo (in print)
- <sup>25</sup> Bean *et al.* (2004)
- <sup>26</sup> Borgwardt (1994)
- <sup>27</sup> Smith (2001)
- <sup>28</sup> Bean *et al.* (2004)
- <sup>29</sup> Smith (2003); Borgwardt *et al.* (2000)
- <sup>30</sup> Backstrom (2000)
- <sup>31</sup> Hansen *et al.* (1997)
- <sup>32</sup> EPA (1999)
- <sup>33</sup> Mahabadi (2001)
- <sup>34</sup> Cahill *et al.* (2004)
- <sup>35</sup> Rollings *et al.* (1992)
- <sup>36</sup> Borgwardt(1994); Bean *et al.* (2004)
- <sup>37</sup> Bean *et al.* (2004)



- Backstrom, M. (2000), Ground Temperature in Porous Pavement During Freezing and Thawing. *Journal of Transportation Engineering*, Vol. 126, No. 5, September/October.
- Bean, E.Z., Hunt, W.F., Bidelspach, D.A., and Smith, D. R. (2004), Study on the Surface infiltration rate of permeable pavements. Biological and Agricultural Engineering Department, North Carolina State University.
- Borgwardt, S., Gerlach, A., and Koehler, M. (2000), *Versickerungsfaehige Verkehrsflaechen, Anforderungen, Einsatz und Bemessungen*, Springer-Verlag, Berlin, Heidelberg.
- Brattebo, B.O. and Booth, D.B. (2003), Long-Term Stormwater Quantity and Quality Performance of Permeable Pavement Systems. Elsevier Press, *Water Research*, Volume 37, Issue 18 , November 2003, pp 4369-4376.
- Cahill, T.H., Adams, M., Marm, C., and Hansen, K. (2004), Pavements that are Stormwater Management Friendly. *LDTonline / Stormwater Management*, Sep 04.
- Dorman, G. and Klomp, A. (1964), *Stress Distribution and Dynamic Testing in Relation to Road Design*. Shell Bitumen No. 18, Shell Oil Company, London, United Kingdom.
- Dunn, I.S., Anderson, L.R., and Kiefer, F.W. (1980), *Fundamentals of Geotechnical Analysis*. John Wiley & Sons, Inc.
- EPA (1998), *Guidance on Storm Water Drainage Wells, Interim Final*. Office of Ground Water and Drinking Water, Office of Water, U.S. Environmental Protection Agency.
- EPA (1999), *Storm Water Technology Fact Sheet, Porous Pavement*. United States Environmental Protection Agency, Office of Water, EPA 832-F-99-023, September 1999.
- Hansen, U., Hoffmann, T., and Wolf, G. (1997), *Versuche an einer Testflaeche mit Wasserdurchlaessigem Pflasterbelag*. Bayrische Forschungsstiftung (Bericht ueber das Forschungs- und Entwicklungsprojekt, Fachbereich Bauingenieurwesen der Fachhochschule Coburg).
- Horner, R.R. and Skupien, J.J. (1994), *Fundamentals of Urban Runoff Management: Technical and Institutional Issues*. Terrene Institute, Washington, DC in cooperation with U.S. Environmental Protection Agency.
- JEGEL (John Emery Geotechnical Engineering Limited) (2000), *Life-Cycle Cost Analysis Interlocking Concrete Pavements*. Interlocking Concrete Pavement Institute (ICPI), Washington, DC.
- Mahabadi, Mehdi (2001), *Regenwasserversickerung, Planungsgrundsätze und Bauweisen*. Thalacker Medien.
- Rollings, R.S. and Rollings, M.P. (1992), *Applications for Concrete Paving Blocks in the United States Market*. Uni-Group U.S.A., Palm Beach Gardens, Florida.

- Rollings, R.S. and Rollings, M.P. (1993), Design Considerations for the Uni Eco-Stone Concrete Paver. Uni-Group U.S.A., Palm Beach Gardens, Florida.
- Schueler, T.R. (1987), Controlling Urban Runoff: A Practical Manual for Planning and Designing Urban BMPs. Department of Environmental Programs, Metropolitan Washington Council of Governments. Prepared for: Washington Metropolitan Water Resource Planning Board.
- Smith, David R. (2001), Permeable Interlocking Concrete Pavements. Interlocking Concrete Pavement Institute (ICPI), Washington, DC.
- Smith, David R. (2003), Permeable Interlocking Concrete Pavement. Public Works, July 2003, Hanley-Wood, LLC., pp 28-32.
- Yoder E.J. and Witczack, M.W. (1975), Principles of Pavement Design. Second Edition, John Wiley and Sons, New York, New York.

## Rain Gardens

### **Definition and Examples**

Rain gardens are shallow excavated garden areas designed to retain stormwater runoff from individual lots and associated impervious areas. They provide an effective runoff filtering mechanism through the vegetation and microorganisms in the root zone. Rain gardens should receive evenly distributed sheet flow but can also receive point discharge runoff. The latter has to be specifically addressed in the rain garden design to prevent erosion and scour. Rain gardens are sized to drain or fully infiltrate the received runoff within approximately 12-hours and are typically planted with grasses and perennials, which help to improve and maintain stormwater infiltration over time.

The term “rain garden” is used here to denote a variety of biofiltration measures designed to filter and/or infiltrate runoff through a vegetated soil surface. For example, linear rain gardens located within parking lot islands are often referred to as biofiltration swales or simply bioswales.

Rain gardens can be combined with other BMPs in this guidance manual. For example, many rain gardens are combined with infiltration trenches to provide for greater infiltration than a rain garden alone and improved water quality and resistance to clogging than an infiltration trench alone. Rain gardens can also be combined with vegetated swales to provide both infiltration and conveyance.

### **Suitable Applications**

Rain gardens are a cost-effective stormwater management application if strategically placed near impervious surfaces such as roof areas (downspout discharge points) and pavements, or other areas that generate runoff, such as lawn areas. Rain gardens can be integrated into new developments and can be retrofitted into existing developments. Suitable areas or development types in which rain gardens can be incorporated are:

1. Residential gardens/yards
2. Commercial development plantings
3. Parking lot landscape islands (often referred to as bioswales)
4. Parkway/right-of-way areas along streets
5. Median strips

### **Benefits**

By minimizing the amount of stormwater that drains to the local storm sewer drainage system, rain gardens help to reduce the potential for flooding and associated bank and shoreline erosion in areas where stormwater discharges into wetlands, streams, and lakes. Rain garden benefits can be summarized as follows:

1. Reduce runoff volumes and rates from roofs, pavements, and lawns
2. Recharge groundwater and sustains base flows to natural water bodies
3. Reduce sediment, nutrient runoff, and other pollutants
4. Can be used to meet Ordinance Volume Reduction standard

Ancillary benefits:

1. Reduces maintenance requirements compared to conventional lawn surfaces or other irrigated plantings
2. Can reduce detention needs
3. Effective land use through combination of stormwater management and ornamental planting
4. Can increase aesthetic value for the property
5. Can diversify site habitat
6. Can reduce the need for costly stormwater infrastructure

### **Limitations**

The following considerations are necessary to sustain the long-term performance of rain gardens:

1. The rain garden surface-area should generally be a minimum 10% to 15% of the contributing impervious area.
2. Rain gardens should not be used for areas with high sediment loadings such as plant nurseries, material storage yards, etc. unless the sediment load can be reduced using filters strips or other measures prior to release to the rain garden. The high sediment load can cause clogging.
3. Rain gardens and other infiltration measures should not be used for areas with potential for contaminated runoff to avoid groundwater contamination. Areas to be avoided include fueling and vehicle maintenance facilities (gas stations) and hazardous materials storage facilities. Runoff from parking lots, roofs, and other typical urban surfaces should not lead to groundwater contamination, provided the design recommendations within the manual are followed.
4. Rain gardens must be protected from construction site runoff and/or the garden must be rehabilitated once the site is stabilized.
5. The drain time for rain gardens should be limited to approximately 12-hours to ensure longevity of the vegetation and prevent complaints. Where soil permeability is insufficient and/or the volume of runoff is too great, an infiltration trench can be placed below the rain garden to increase the available storage volume.
6. Rain gardens should not be placed over septic systems and should be located at least one-hundred feet (100') from private well heads and four-hundred feet (400') from public water supply wells.
7. Rain gardens must have a minimum of two feet (2') of separation above the seasonal high ground water table.

8. Rain gardens should not be placed over contaminated soils.
9. Rain gardens should be located at least 10-feet down slope from building foundations unless adequate waterproofing is provided and direct drainage to footing drains can be prevented.

### **Required Design Data**

#### Soil type and permeability:

The infiltration capacity of the subsoils under the rain garden will determine the volume of runoff that can be exfiltrated from the rain garden into the ground over a given time. The infiltration capacity, along with the contributing watershed will help to determine the rain garden size.

The Kane County Soil Survey provides some guidance with regards to soil permeability. It is, however, recommended that a hydraulic conductivity test be performed at the location and elevation of the proposed rain garden bottom to establish the site-specific permeability rate (double ring infiltrometer test per ASTM D3385, lab test per ASTM D2434 through a Shelby tube sample, or have a Certified Professional Soil Classifier conduct an on-site soil investigation to determine soil suitability or a Falling Head Percolation Test. The data from the infiltration test will allow for adequate sizing and design of the rain garden.

#### Seasonal high water table:

If the site in question for the rain garden placement is known to have a relatively high water table, data on the elevation of the seasonal high water table is needed. The invert of the rain garden (lowest point in the cross-section) shall be at least two feet (2') above the seasonal high water table<sup>1</sup> to provide adequate runoff treatment prior to discharge into shallow ground water.

#### Contributing drainage area and imperviousness:

Along with the infiltration capacity, the drainage area and level of imperviousness contributing to the rain garden are needed to determine its size.

### **Rain Garden Design**

#### Rain garden location:

As a general rule, rain gardens should be located adjacent to or near the impervious surfaces they are designed to treat.

#### Topography:

Place the rain garden in flat areas to maximize the surface area for infiltration. Construct the rain garden with a shallow slope at the edges and flat invert to allow for even runoff distribution and infiltration. Avoid low areas with a longer ponding time, which may cause sediment accumulation and sealing. If the rain garden must be constructed in sloping terrain, give it a linear shape and place it along a contour, or terrace the rain garden along the slope.

#### Building foundation and basements:

Some references call for a minimum set back of 10-feet from any building foundation. Another rule that can be applied to protect building basements is to set back the rain garden 1.5-times the distance of the building foundation depth<sup>2</sup>. These rules may not apply to foundation that are water proofed and where no leakage into the footing drain is assured.

#### Light level conditions:

An important component of rain garden design is the planting of grasses and sedges with strong fibrous root systems. Such root systems contribute to the buildup of soil organic carbon that ensures the longevity of the rain garden's filtration and infiltration capacity. In order to maximize the production of soil organic carbon, the grasses and sedges need to be 'fueled' by sufficient sunlight. The placement of the rain garden in full sun or partial sun conditions is preferable. Sites that are exposed to full sun for about half the day are suitable for rain gardens.

#### Seasonal high water table:

The rain garden invert will need to be a minimum of two feet (2') above the seasonal high water table to provide adequate runoff treatment prior to discharge into shallow ground water. The greater the separation between the seasonal high water table and rain garden invert, the more effective the runoff treatment.

#### Rain garden ponding depth and drain time:

The drain time for rain gardens should be limited to 12-hours and the depth of ponding should generally be limited to 18-inches. However, greater depths may be appropriate if the duration can be limited to less than 12-hours.

The time necessary to drain the rain garden should be no more than approximately 12-hours to ensure the health of the vegetation in the rain garden and to avoid complaints. In many cases, the drain time and soil permeability will determine the maximum depth of ponding. For example, if the infiltration capacity of the soils is 1-inch/hour, the maximum depth would be 12-inches, if the infiltration capacity is 0.5-inches/hour, the maximum depth would be 6-inches.

In higher permeability soils, it may be feasible to support greater depths of ponding without exceeding the 12-hour duration. However, to protect the health of the vegetation, the depth should generally be limited to 18-inches unless the duration can be reduced to less than 12-hours. For example, certain areas of Kane County have permeability rates as high as 5- inches/hour. In these areas, it may be appropriate to use greater depths since even a 24-inch deep rain garden would drain in less than 5-hours.

Where greater depths of ponding are necessary due to space constraints, rain gardens can be placed over infiltration trenches for which the maximum recommended drain time is 72-hours<sup>3</sup> (see also Section 0).

#### Rain garden area:

Although the term rain garden conjures images of small backyard gardens, there is no size limit to the area of a rain garden. Thus, a rain garden could be as large as what is commonly known as an infiltration basin, provided the guidance in this document is followed, including ponding depth and drain time described above.

To minimize the potential for clogging at the bottom of the rain garden and to maximize the runoff volume potential, the rain garden area should not be less than 10% to 15% of the impervious drainage area.

#### Runoff treatment:

High runoff temperatures and poor water quality can stress the rain garden vegetation and their root systems that are important to ensure the system's long-term performance and aesthetics. Runoff water quality can be improved and temperatures reduced by routing impervious runoff through level spreaders and vegetated filter strips.

High runoff temperatures can also be mitigated through the point discharge dissipation approaches.

#### Flow energy dissipation:

Energy dissipation is often necessary to prevent scour where runoff enters the rain garden. At curb cuts along a street or within a parking lot or for residential downspouts, only nominal energy dissipation such as a splash pad or small amount of stone may be necessary. For large flow rates (entering larger rain gardens), larger rip rap material, level spreaders or inflow chambers may be necessary.

#### Level spreader:

Level spreaders can be as simple as a gravel edge where the parking surface meets the rain garden or can be more complex such as long gravel trenches containing perforated pipe to distribute the runoff over the length of the spreader. In addition to dissipating energy and distributing the runoff, level spreaders provide cooling of the first flush runoff from high temperature paved or roof surfaces.

#### Inflow-chamber:

Route point discharge to an inflow-chamber in the rain garden. The inflow-chamber functions like a drywell in reverse, allowing the runoff to slowly rise by head pressure and flow into the rain garden.

#### Rain garden top soil:

Eight to 12-inches of loamy sand/sandy loam topsoil should be placed in the bottom of the rain garden to provide filtration and a growing media for the vegetation. The topsoil should generally conform to the following specifications to ensure adequate permeability and growing conditions.

1. 70% medium to coarse sand (IDOT FA2)
2. 8% to 10% organic content
3. Less than 10% clay
4. Compaction of 70% (modified) to 75% (standard) max. dry density

In some cases, the existing site topsoil may meet the specifications above. In other cases, site topsoil may need to be amended with coarse sand (IDOT FA2) and/or organic material such as leaf compost. The specifications section provides detail on the amended topsoil.

Where a rain garden is located above an infiltration trench, the minimum amended topsoil depth should be 8-inches. Where the rain garden is located directly on subgrade soils, the amended topsoil depth should be increased to 12-inches unless the subgrade soils have a tested infiltration capacity greater than 1-inch/hour.

#### Vegetation design:

The use of perennials, fibrous rooted grasses, and sedges will enhance the rain garden's longevity and improve water quality benefits. The extensive root system of native grasses and forbs contribute to the sustainability of soil organic carbon that ensures the longevity of the rain garden's filtration and infiltration capacity. Native grasses alone will achieve the rain garden objectives. However, forbs are often added to achieve certain aesthetic objectives. The vegetation of a rain garden depends on a number of factors.

In spite of the name "rain garden" the vegetation should be that which flourishes in soils that are neither particularly wet nor particularly dry. Rain gardens located over infiltration trenches or high permeability soils must be tolerant of dry conditions.

Native grasses and sedges need to be 'fueled' by sufficient sunlight to produce soil organic carbon. The placement of the rain garden in full sun or partial sun conditions is thus preferable.

Use of the recommended native grasses, forbs, and sedges in a rain garden does not mean that the appearance automatically translates into a "naturalistic" look. Midwestern native vegetation provides sufficient variation in flowering color, flowering time, textures, and plant heights to create rain garden plantings that provide an ornamental "flowering border" appearance, or even a formal design. The latter two options will require more maintenance than a "naturalistic" planting.

If mowed more often than once a year or planted with a low ratio of grasses and sedges, soil organic carbon will deplete over time. This may reduce the water quality benefits of the rain garden over time. It may also lead to a slow loss of infiltration capacity that may need to be restored by tilling in additional organic material.

#### **Construction Considerations**



Construction of rain gardens requires special care and changes to normal construction practice and schedules for the optimal functioning of the rain garden facility and its long-term viability.

#### Soil Erosion And Sedimentation Control:

Soil erosion and sediment control practices should be maintained and inspected on a regular basis. Accumulated sediments within on-lot sediment traps and along silt fences should be promptly removed. All disturbed areas shall be promptly stabilized and compromised erosion and sediment control devices should be promptly repaired.

Stockpiles should be located downstream of rain garden facility; if unable to do so, stockpile shall have a double row of silt fence that surrounds the perimeter of the stockpile.

Before the rain garden goes online, the contributing drainage area must be stabilized/fully vegetated.

Rain garden facility shall be stabilized with vegetation and erosion blanket prior to facility receiving stormwater runoff.

#### Avoidance Of Soil Compaction And Contamination:

Soil compaction in the rain garden area must be avoided to conserve the permeability rate of the existing subsoils.

Areas where rain gardens are to be located should be protected from construction traffic using construction fencing or other barriers.

Avoid working on or with soils that are excessively wet or saturated.

Excavation of the rain garden should be performed using a backhoe or other equipment that can be staged outside the rain garden facility during excavation operations. Where the rain garden is too large to be excavated from outside the garden, low ground pressure equipment should be used and the area tracked by the equipment should be minimized.

#### Amended soil mix:

After placement of topsoil, the rain garden facility must be protected from construction impacts, including placement of building materials and foot and vehicle traffic.

When onsite topsoil needs to be amended, the recommended method of amended soil mix placement is:

1. Mixing of the amended soil outside of the rain garden area.
2. Unloading of the amended soil at the rain garden edge.
3. Spreading of the amended soil with a backhoe or other equipment that can be staged outside the rain garden facility.

4. Manual fine grading, such as raking.
5. Compaction using a roller or other equipment that will provide adequate compaction to support moderate foot traffic but not exceed 80 to 85% compaction.

Vegetation installation:

Prepare seed bed through manual means or use low ground pressure equipment.

Hand broadcast seed or use low ground pressure seeding equipment.

Install erosion control blanket and plant live material by carefully slitting slots into the erosion blanket.

The success of a rain garden installation can be assured by simple proactive measures. It is recommended that the consultant meet with the contractor prior to construction to discuss the above listed items, construction sequencing and construction schedules. Supervisory construction staff, such as the foreman, should participate in the meeting. Construction inspections should be mandatory at crucial junctures to verify compliance with design parameters and specifications.

### **Operation and Maintenance**

Rain garden maintenance can be greatly reduced by taking a proactive approach during construction. The greater the care taken during construction, the fewer items there will be to look after or to repair. Care during construction will also assure a smooth and shortened establishment period, which reduces intensive maintenance requirements.

The following activities should be completed routinely in the first two to three years of establishment: erosion repair, weed control, and supplemental watering. After full vegetation establishment, the required maintenance within rain gardens that use native grasses, sedges, and perennials in a naturalistic fashion should be minimal. More intensive maintenance may be required in rain gardens that use ornamental and non-native species but no greater than the maintenance required of a typical perennial garden.

Vegetation management:

Initially, plant plugs and other live material should be watered immediately after planting and continue to be watered as necessary until plugs are rooted into the ground, unless there is adequate rainfall.

During the plant establishment period – up to 3-years after installation – monthly site visits during the growing season (April – October) should be undertaken to identify and carry out maintenance requirements.

If a rain garden is seeded and plugged, the establishment period may be only 1.5 to 2-years, depending upon the success of the initial weed and weed seed bank treatment and the vigilance of the initial weed control.

Due to the typical size of a rain garden, the most effective manner of weed control will be hand weeding and/or use of appropriate herbicide (by licensed applicator). To determine the appropriate weed control, one has to distinguish between annual weeds and perennial weeds. The former requires a less intense control than the latter.

#### Annual weeds:

Annual weeds do not need to be pulled but only to be cut/trimmed back to prevent them from flowering and setting seed. In rain gardens that use native prairie vegetation, control of annual weeds can also be achieved in the first growing season through mowing, cutting vegetation to a height of 6-inches to 8-inches. A string trimmer may also be used to cut vegetation to this same height. Where vegetation growth is heavy, cuttings should be removed to prevent smothering of the desirable rain garden vegetation. Mowing should be conducted when the weed vegetation reaches a height of 12 to 15-inches and before any noxious weeds set seed.

#### Perennial weeds:

Perennial weeds should be hand pulled or spot treated with herbicide (by licensed applicator). Hand pulling should include the removal of all above ground and belowground stems, roots, and flower masses prior to the development of seeds. Care should be taken to disturb as little soil as possible during hand pulling to avoid exposure of additional weed seed in the soil layer, and to protect adjacent emerging seedlings. Care must be taking during herbicide spot treatment to avoid damaging surrounding vegetation.

After sufficient graminoid (grasses and sedges) development to provide an adequate fuel source in rain gardens with native prairie vegetation, annual burn management should be implemented. Burning dead plant material reduces weed growth, stimulates native grass and forb growth, and increases nutrients available to the plants. In rain gardens where burning is difficult or impossible, the vegetation should be mowed annually in fall or spring. To mimic the burn cycle all clippings and thatch must be removed after mowing. Please note that mowing does not provide the full benefit to native prairie vegetation that fire provides and will often result in a lower ratio of wildflowers (forbs) relative to the grasses.

Rain gardens planted with ornamental plants and/or non-native species may require cutting back and winter protection of individual species as part of winter preparations typical of any ornamental garden. These rain gardens may also require thinning of some plants to encourage the development of other species.

#### Debris removal:

In those systems where there is no burn regime, dead plant debris, trash, leaves and any other material that may obstruct infiltration or smother desired vegetation should be removed. Dead plant stalks should be cut back or mowed each spring.

#### Sedimentation removal:

If the rain garden is properly designed and protected from sedimentation through use of an adequate pretreatment area, the rain garden basin is likely to maintain its effectiveness for many years (20+ years). The rain garden basin should be scraped and replanted when accumulated sedimentation is one-quarter of the basin depth.

The initial erosion and sediment control inspections should identify and initiate remediation of any early signs of erosion or sedimentation within the rain garden basin. Thereafter, annual inspections for sediment accumulation within the pretreatment area and basin should occur.

#### Rain garden easement protection:

The Ordinance requires that stormwater features (such as a rain garden) are protected by an easement (Category II) or Declaration of Restriction and Covenant (Category I). All rain garden areas that are part of the submitted and approved stormwater management system thus are required to be in an easement. If rain gardens are not part of the stormwater management system, such as a rain garden installed by a homeowner on his or her own accord, it is exempt from the easement requirement.

## Typical Detail

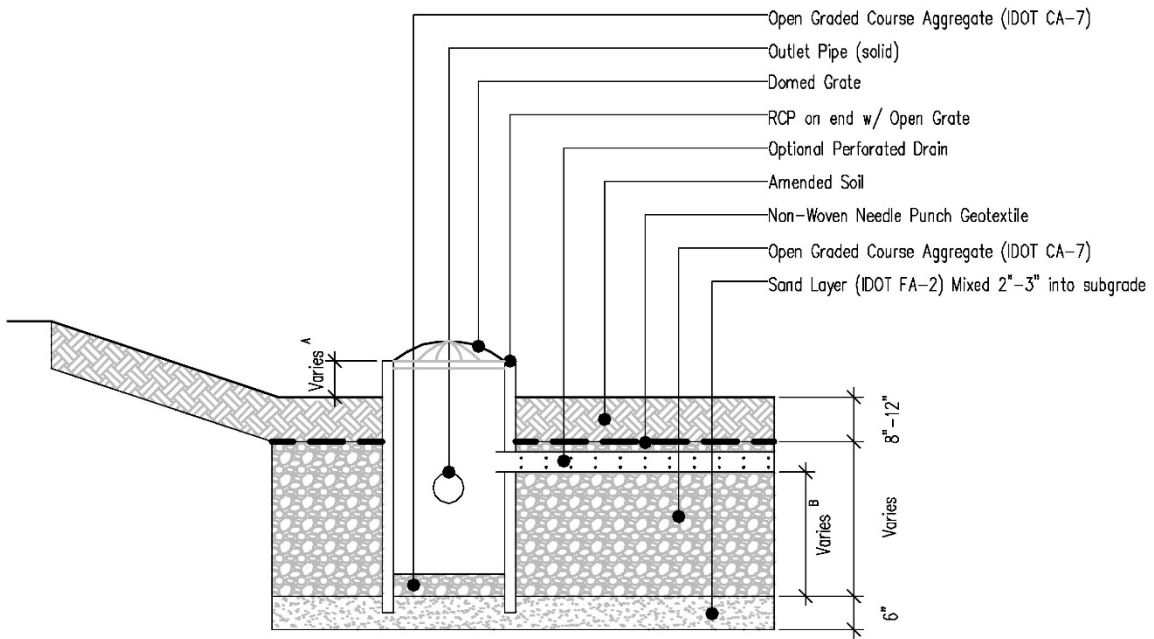

- A) Surface drain time not to exceed 12 hours; max. depth 18"
- B) Total drain time (surface plus subsurface) not to exceed 72 hours

### Raingarden Section with Infiltration Trench and Outlet Structure

Not to Scale

Figure 5 – Rain Garden Section with Infiltration Trench (in profile) and Outlet Structure

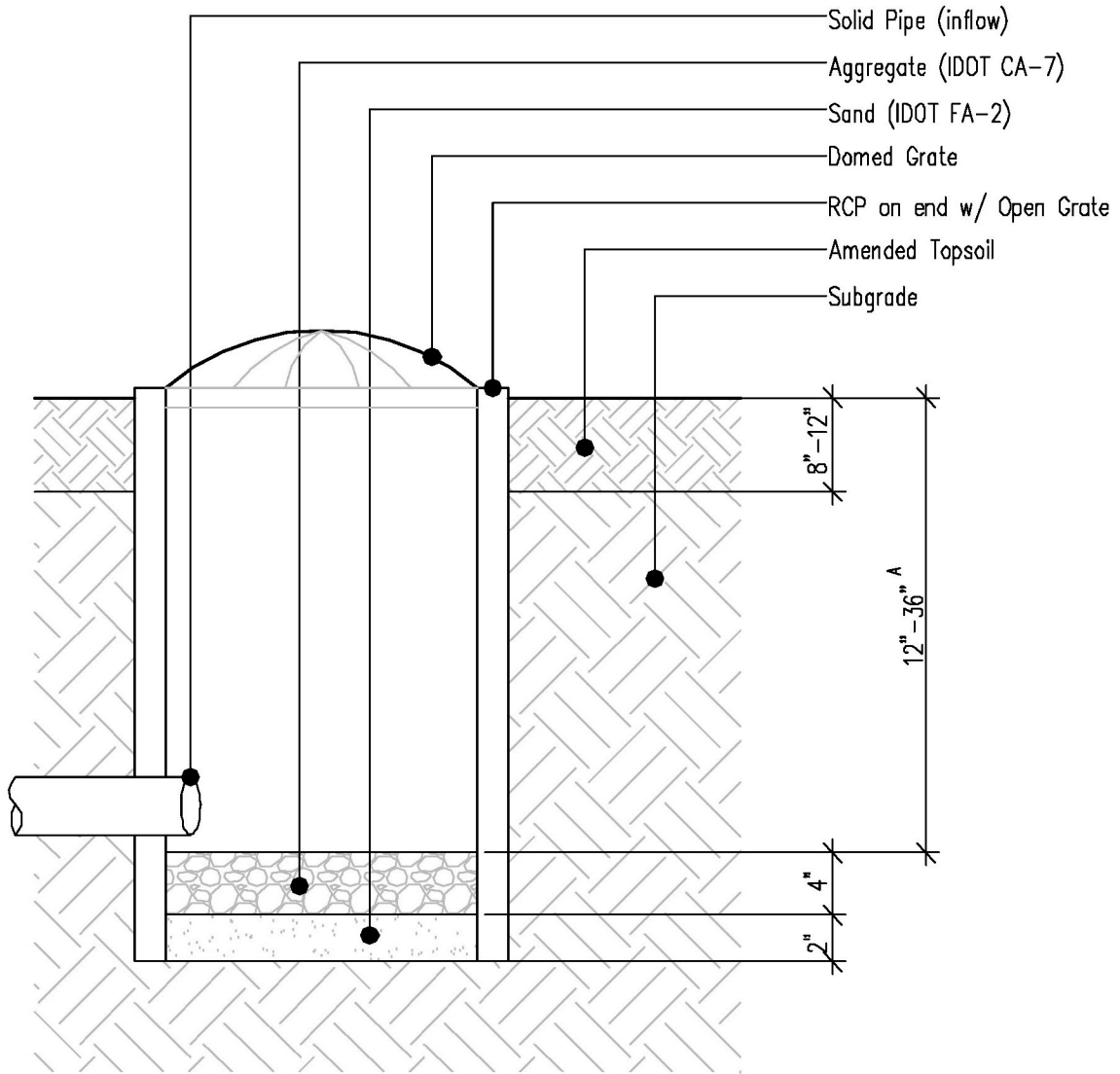

A) Total drain time not to exceed 72 hours

### Inflow Chamber

Not to Scale

Figure 6 – Inflow Chamber Detail

<sup>1</sup> Barr Engineering Company (2001)

<sup>2</sup> Mahabadi (2001)

<sup>3</sup> Barr Engineering Company (2001)

<sup>4</sup> Northern Virginia Planning Commission and Engineers and Surveyors Institute (1992); MA Department of Environmental Protection (1997); Lowndes, M.A. (2000); Los Angeles County Department of Public Works (2002).

Barr Engineering Company (2001), Minnesota Urban Small Sites BMP Manual Stormwater Best Management Practices for Cold Climates, Metropolitan Council Environmental Services.

MA Department of Environmental Protection (1997), Stormwater Management, Volume Two: Stormwater Technical Handbook.

Mahabadi, Mehdi (2001), Regenwasserversickerung, Planungsgrundsätze und Bauweisen. Thalacker Medien.

Northern Virginia Planning Commission and Engineers and Surveyors Institute (1992), Northern Virginia BMP Handbook: A guide to planning and designing best management practices in Northern Virginia.

Los Angeles County Department of Public Works (2002), Development Planning for Storm Water Management: A Manual for the Standard Urban Storm Water Mitigation Plan (SUSMP).

Lowndes, M.A. (2000), The Wisconsin Storm Water Manual: Infiltration Basins and Trenches (G3691-3). Wisconsin Department of Natural Resources, Madison, Wisconsin.



## Infiltration Trenches

### Definition

Infiltration trenches are excavations filled with open graded aggregate for temporary stormwater runoff storage. Although the term “trench” implies a linear feature, the aggregate reservoir may occupy any shape.

The stored runoff in the aggregate reservoir must be partially or fully infiltrated into the ground in no less than one (1) day and no greater than five (5) days of the storm event. The infiltration trench thus provides runoff volume control, recharges shallow ground water and helps to sustain base flows. In the case of partial infiltration, excess runoff is collected through a perforated pipe or other drain and conveyed to additional BMPs downstream.

Infiltration trenches may be combined with other BMPs in this guidance manual, such as rain gardens to meet the Ordinance’s Volume Reduction standard.

### Suitable Applications

Infiltration trenches improve the retention capacity of the site by increasing the storage volume available for infiltration, increasing the allowable drain time, and may facilitate connection to a lower lying soil horizon that has a better infiltration capacity. In this case, the infiltration trench will function as a linear dry well. It is critical, though, to ensure that the invert of the infiltration trench has a minimum of two feet (2’) from the seasonal high water table to reduce the risk of ground water contamination.

Infiltration trenches are ideal for residential, commercial and mixed-use developments. Their physical configuration allows integration into narrow areas, such as along parking lot edges and within parking lot islands and medians. The contributing area should not exceed five-acres<sup>1</sup>.

### Benefits

1. Suitable for narrow and small spaces that cannot accommodate larger conventional treatments
2. Good pollutant removal capabilities<sup>2</sup>
3. Facilitates decentralization of the stormwater system, particularly when incorporating detention into the aggregate reservoir
4. Potential increase in retention capacity through penetration of shallow soil horizons that have a low permeability rate
5. Shallow and deep groundwater recharge and subsequent improved and sustained base flows to natural water bodies
6. Reduction of the total runoff volume and subsequent reduction of potential flooding and associated bank and shoreline erosion in areas where stormwater discharges into wetlands, streams, and lakes

## 7. Can be used to meet Ordinance Volume Reduction standard

### **Limitations**

Infiltration trenches are subject to clogging by high sediment loads (even with an amended soil filter) and, therefore, are not suitable for areas such as construction sites, agricultural sites, or plant nurseries. In short, infiltration trenches should not be used if the sediment load in upstream areas cannot be controlled.

Infiltration trenches are not suitable for manufacturing and industrial sites, automobile service facilities, and other land uses with potential for high concentrations of pollutants due to accidental or other releases, or for sites that may receive high levels of pesticides or pathogens.

To minimize the risk of pollution, the invert of the infiltration trench must have a minimum two feet (2') of separation from the season high groundwater table.

Infiltration trenches require a minimum separation from private (one-hundred feet) and public water supply wells (four-hundred feet). It is recommended that the designer reference the private and public water supply standards to determine current standards. It is further recommended that infiltration trenches be located at least 10-feet down-slope and 100-feet up-slope from building foundations<sup>3</sup> unless the invert of the trench is below the footing elevation, adequate waterproofing is provided and direct drainage to footing drains can be prevented.

The contributing watershed to the infiltration trenches should not exceed 2-acres<sup>4</sup>. Infiltration devices should not be located adjacent to high and steep slopes where seepage could destabilize the slope.

Infiltration trenches should not be located on soil fill to avoid excessive settlement and loss of fill stability. However, the trench may be located on granular fill that will remain stable when saturated.

### **Required Design Data**

Soil type and permeability:

The infiltration capacity of the subsoils under the infiltration trench will determine the volume of runoff that can be exfiltrated into the ground over a given period of time. The infiltration capacity, along with the porosity of the open graded aggregate fill, the required drain time, and contributing watershed should all be factored into the infiltration trench dimensions.

The Kane County Soil Survey provides some guidance with regard to soil permeability. In general terms, soils with a 30% or greater content of clay or 40% or greater content of silt and clay combined tend to have insufficient infiltration capacity<sup>5</sup>. Likewise, soils

with an infiltration rate greater than 5-inches/hour or a combined silt/clay content less than 5% may not be suitable because of limited capacity to remove pollutants<sup>6</sup>.

It is recommended that a hydraulic conductivity test be performed at the location and elevation of the proposed infiltration trench invert to establish the site-specific permeability rate (double ring infiltrometer test per ASTM D3385, lab test per ASTM D2434 through a Shelby tube sample, or have a Certified Professional Soil Classifier conduct an on-site soil investigation to determine soil suitability or a Falling Head Percolation Test (described in Appendix A). A minimum of two soil investigations should be performed per infiltration trench. If the trench is longer than 100-feet, one additional sampling for each 100-foot increment is recommended<sup>7</sup>. On sites with cohesive soils the lowest recorded infiltration rate should be used for the sizing and design<sup>8</sup>. On sites with varying soils (and varying hydraulic conductivity) the lowest recorded infiltration rate per soil type should be used. The data from the hydraulic conductivity test will allow for adequate sizing and design of the infiltration trench.

Seasonal high water table:

The invert of the infiltration trench should be at least two-feet (2')<sup>9</sup> to above the seasonal high water table to reduce the potential for shallow ground water contamination.

Contributing drainage area:

It is recommended that the drainage area to the infiltration trench be limited to two acres<sup>10</sup> to protect the device from excess sediment loads and high flow rates at inflow points. A larger number of smaller devices is less likely to fail than a single facility treating a large area.

Infiltration Trench Design:

Infiltration trenches may be combined with rain gardens and vegetated swales where these systems, by themselves, do not meet the Kane County Volume Reduction standard or where a higher degree of retention is desired.

Runoff to the rain gardens or vegetated swales passes through an amended top soil with high hydraulic conductivity into the top of the infiltration trench. This process improves the runoff quality entering the trench by removing suspended solids and pollutants from the runoff. When underlain with a geotextile it protects the infiltration trench from sediment accumulation and subsequent clogging. The vegetated amended top soil must be designed to sustain its hydraulic conductivity over time<sup>11</sup>. It should generally conform to the following specifications to ensure adequate permeability (2- to 5-inches/hour) and growing conditions:

1. 70% medium to coarse sand (IDOT FA2)
2. 8 to 10% organic content
3. Less than 10% clay
4. Compaction of 70% (modified) to 75% (standard) max. dry density

The following subsections describe the various key design elements.

**Site selection:**

The infiltration trench must be located down gradient from the contributing drainage area. The placement must further allow for overflow of excess runoff with a suitable outfall. Areas that become unstable under saturated conditions, such as locations close to cut or fill slopes, are unsuitable for infiltration trenches. Furthermore, infiltration trenches shall not be placed over fill, but must exfiltrate into natural, undisturbed soils with adequate infiltration capacity.

**Soils:**

The first step in the design process is to determine the suitability of the soils and their hydraulic conductivity. It is not uncommon to find very low infiltration rates in the A-horizon (either because of the soil type or compaction), while soils in the underlying horizons offer a higher infiltration capacity. Part of the design process is to seek permeable soil horizons that allow the infiltration trench to drain within the specified time. The elevation of the permeable horizon partially determines the depth of the infiltration trench. Other factors are adequate separation from the seasonal high water table and the infiltration rate, which determines the volume that can be exfiltrated. The latter is further influenced by the surface area over which the exfiltration takes place – in other words – the surface area of the infiltration trench invert. As a general rule, the invert area of the trench must increase with lower permeability soils to achieve the retention standard without exceeding the allowable drain time. The trench invert should be flat to allow for uniform distribution and infiltration of the runoff.

**Topography and access:**

Infiltration trenches should not be located adjacent to steep slope where seepage could destabilize the slope. The placement of infiltration trenches should take into consideration the need for vehicular maintenance access.

**Foundation protection:**

Infiltration trenches should be placed at least 10-feet down-slope and 100-feet up-slope from building foundations<sup>12</sup> unless the invert of the trench is below the elevation of the foundation. Another rule that can be applied to protect building basements is to set back the infiltration trench 1.5 times the distance of the building foundation depth<sup>13</sup>.

**Groundwater protection:**

To avoid contamination of shallow groundwater, infiltration trenches should not be applied on sites such as automobile service facilities and sites where there is potential for stormwater to come in contact with hazardous materials. The invert of the infiltration trench shall be at least two-feet (2')<sup>14</sup> above the seasonal high water table.

To protect public water supplies, infiltration trenches require a minimum separation of 100-feet from private wells<sup>15</sup> and 400-feet from public water supply wells.

**Permanent sedimentation control and protection:**

Infiltration trench design requires provisions for sedimentation control to prevent failure through clogging. Any design that incorporates infiltration trenches must have an erosion and sedimentation control plan in place and the practices must be maintained. It is imperative that stormwater bypass the infiltration trench area during construction until the contributing watershed is fully stabilized.

If a temporary sedimentation pond is placed in the area of the planned infiltration trench, a minimum 12-inches separation between the bottom of the sedimentation pond and the final invert of the infiltration trench is necessary<sup>16</sup>.

To protect the infiltration trench from clogging over its lifetime, direct discharge of runoff into the trench should be avoided wherever possible. Instead, the runoff should be filtered through vegetated amended top soil.

**Infiltration trench drain time:**

The duration of ponding within an infiltration trench should not exceed 72- hours to ensure that the volume is available for subsequent events and to avoid sealing of the subgrade soils due to growth of biological slimes. The duration that water will be contained within in the trench is approximately equal to the storm duration plus the drain time. (Drain time is equal to the time required to drain the trench from full assuming no inflows.) For a 24-hour storm duration, the drain time should be limited to 48-hours.

The maximum allowable drain time, along with the subgrade permeability, will contribute to the maximum depth of the infiltration trench.

**Overflow and subsurface drainage design:**

To assure safe bypass for excess runoff flows, infiltration trenches require an overflow.

Infiltration trenches in combination with vegetated swales or rain gardens may or may not require a subsurface drainage mechanism to dispose of excess water when the retention storage capacity is exceeded.

If the infiltration trench is combined with a vegetated swale and sized for the 1.0-inch Volume Reduction standard only, no subsurface drain structure is needed. The trench can be allowed to fill up through the vegetated amended top soil, where excess runoff is drained through surface conveyance in the vegetated swale.

If the infiltration trench is combined with a rain garden and sized to drain the 1.0-inch Volume Reduction standard within the required time frame, no subsurface drain structure is needed since the excess runoff can drain through the rain garden overflow.

The outfall of any subsurface drainage system must be designed to prevent erosion, scour and concentrated flows.

A backflow prevention flap valve may be necessary to prevent sediment laden runoff from entering the system.<sup>17</sup>

Observation wells and clean outs:

It is recommended that all infiltration trenches be outfitted with an observation well (four to six-inch perforated pipe with a cap on an anchor plate) located in the center of the trench.

Infiltration trenches with subsurface drainage structures (perforated pipes) should have a cleanout at each end, which can also be modified to serve as observation wells. Cleanouts should also be provided at each significant change in direction. Another function of the observation wells and cleanouts is to provide air vents while the trench fills with runoff<sup>18</sup>.

Materials:

The infiltration trench should be lined with a 6-inch sand layer (IDOT FA2) at the bottom<sup>19</sup>. The sand will act as a filter layer and prevent compaction of the trench invert during the aggregate fill placement. The bottom 2-inches of the sand should be vertically mixed 2-inches into the subgrade<sup>20</sup>.

The aggregate fill shall consist of open graded IDOT CA1 or CA7, preferably washed to prevent the introduction of remaining fines. The porosity for these open graded aggregates is approximately 0.36. Rigid perforated pipes or storm chambers can be integrated into the infiltration trench to reduce the amount of gravel and increase the trench storage.

The vertical sides of the infiltration trench should be lined with a non-woven needle punch geotextile to prevent migration of the adjacent soils into the open graded aggregate. A separate piece of non-woven needle punched geotextile should be placed on top of the open graded aggregate fill as a filter and sediment barrier. It is further recommended to place a one-inch sand layer (IDOT FA2) on top of the geotextile, prior to the placement of the amended top soil. The sand layer will reduce the risk of “blinding” the geotextile and sustain the capacity to pass runoff into the infiltration trench<sup>21</sup>.

Infiltration trench sizing:

To meet the Kane County Volume Reduction standards, infiltration trenches should be sized for 1.0-inch of runoff over the impervious area draining to the trench. Trenches may also be sized for larger events to increase retention and reduce downstream detention needs.

Trenches may also be used for detention credit. The drawdown for trench should be a minimum of one (1) day and a maximum of four (4) days. The drain pipe can be fitted with a restrictor for controlled and slow release. The restrictor shall be located at a cleanout or manhole for easy maintenance access.

## **Construction considerations**

The area set aside for infiltration trenches should be protected with construction fencing during grading operations to protect it from construction traffic and compaction<sup>22</sup>.

#### Sedimentation control:

Construction of the infiltration trench should not start until the all erosion and sedimentation control measures are in place or the contributing watershed is stabilized and/or runoff diverted from the infiltration trench site. It is imperative that stormwater bypass the infiltration trench area during construction until the contributing watershed is fully stabilized. Furthermore, the infiltration trench should not go into service until the entire contributing watershed is stabilized and the risk of erosion and sedimentation eliminated.

An excavated infiltration trench should never be used as a temporary sediment trap for construction site runoff<sup>23</sup>. If a temporary sedimentation pond is placed in the area of the planed infiltration trench prior to excavation, a minimum of 12-inches of undisturbed soil between the bottom of the sedimentation pond and the final invert of the infiltration trench are necessary<sup>24</sup>.

#### Excavation:

To preserve the infiltration capacity of the infiltration trench, it is imperative that the invert is not compacted or smeared during the excavation process. Suitable excavation equipment is backhoes (with toothed buckets) or similar equipment that can be staged outside the infiltration trench area. Bulldozers or front end loaders are not suitable for infiltration trench excavation.

The excavated material should be placed 10-feet away and to the downstream side of the trench to prevent re-deposition during storm events<sup>25</sup>. Larger tree roots should be cut flush with the walls to protect the geotextile from puncturing and tearing during placement and filling of the infiltration trench.

#### Geotextile placement:

The vertical infiltration trench walls should be lined with a non-woven needle-punched geotextile. The geotextile must be installed flush with the vertical trench walls. It is recommended to cut the geotextile to the appropriate dimensions prior to placement. Allow for six-inch overlap at the top of the trench. The overlap between two ends should be at least two feet, where the upstream section must overlap the downstream section<sup>26</sup> (shingle effect). A separate precut geotextile should be placed horizontally over the aggregate prior to covering the infiltration trench with torpedo sand and amended top soil layers. The horizontally placed geotextile must be installed as an individual unit to allow for easy removal in case of remedial maintenance (see Figure 79 – Infiltration Trench Detail).

It is imperative that the geotextile is placed properly, with the indicated overlaps to prevent immediate and future sedimentation and subsequent clogging of the infiltration trench.

Filling of infiltration trench:

It is recommended to line with infiltration trench with a 6-inch torpedo sand layer (IDOT FA2) at the bottom<sup>27</sup>. The sand will act as a filter layer and reduce the risk of compaction of the trench invert during the aggregate fill placement. In case of a very broad trench, all sand must be placed ahead of the loader to prevent compaction and smearing of the trench invert. The first three inches of sand should be vertically mixed with the subgrade soils to a minimum depth of 2-inches prior to placing the remaining three inches.

As with the sand, the aggregate should be placed with a low ground pressure backhoe or front loader and the gravel should be placed ahead of the equipment to minimize compaction. The aggregate should be placed in lifts of 12-inches and compacted lightly with plate compactor.

All aggregate must be kept clean and uncontaminated at all times. Materials contaminated with soil, silt, or sediments must be removed and replaced.

### **Operation and Maintenance**

Once the infiltration trench is online, it should be inspected several times after rain events to assure proper functioning and drain times. Routine maintenance inspections should be conducted on an annual basis<sup>28</sup>, preferably after a significant rain event. The observation well should be inspected for proper drainage and the surface should be inspected for sediment accumulation, vegetation health, and proper drainage through the amended top soil.

If the subsurface trench is continuing to hold water long after the design drain time, the trench bottom has likely become clogged with sediments. Provided that the trench was properly installed and protected from construction site runoff, this is a very unlikely scenario. However, if clogging occurs the infiltration trench will need to be reconstructed to remove the sediments and restore the exfiltration capacity.

If water is ponding for extended periods on top of depressional areas above the trench (but not within the subsurface trench), there two are likely causes:

1. If water is found ponding on top of the depressional area, whereas the bottom of the top soil does not seem as saturated (as determined with a soil probe), it is likely that sediment accumulation on top of the topsoil has clogged the soil. Removal of the sediments and replacement of the top one (1) inch above the topsoil above the may suffice to restore the infiltration rate.
2. If water is ponded and the topsoil is saturated throughout its profile (as determined using a soil probe), it is likely that the geotextile on top of the infiltration trench is clogged. This will require replacement of the geotextile and reapplication of the top soil and vegetation. The placement of a one-inch torpedo sand layer (IDOT FA2) on top of the geotextile, prior to the placement



of the top soil will reduce the risk of blinding the geotextile and sustain its capacity to pass runoff through to the infiltration trench<sup>29</sup>.

### **Infiltration Trench Easement**

The Kane County Stormwater Management Ordinance requires that stormwater features (such as infiltration trenches) be protected by an easement (Category II) or Declaration of Restriction and Covenant (Category I). Thus, all infiltration trenches that are part of the submitted and approved stormwater management system are required to be in an easement. If infiltration trenches are not part of the stormwater management system, such as a trench installed by a homeowner on his or her own accord, it is exempt from the easement requirement.

## Typical Detail

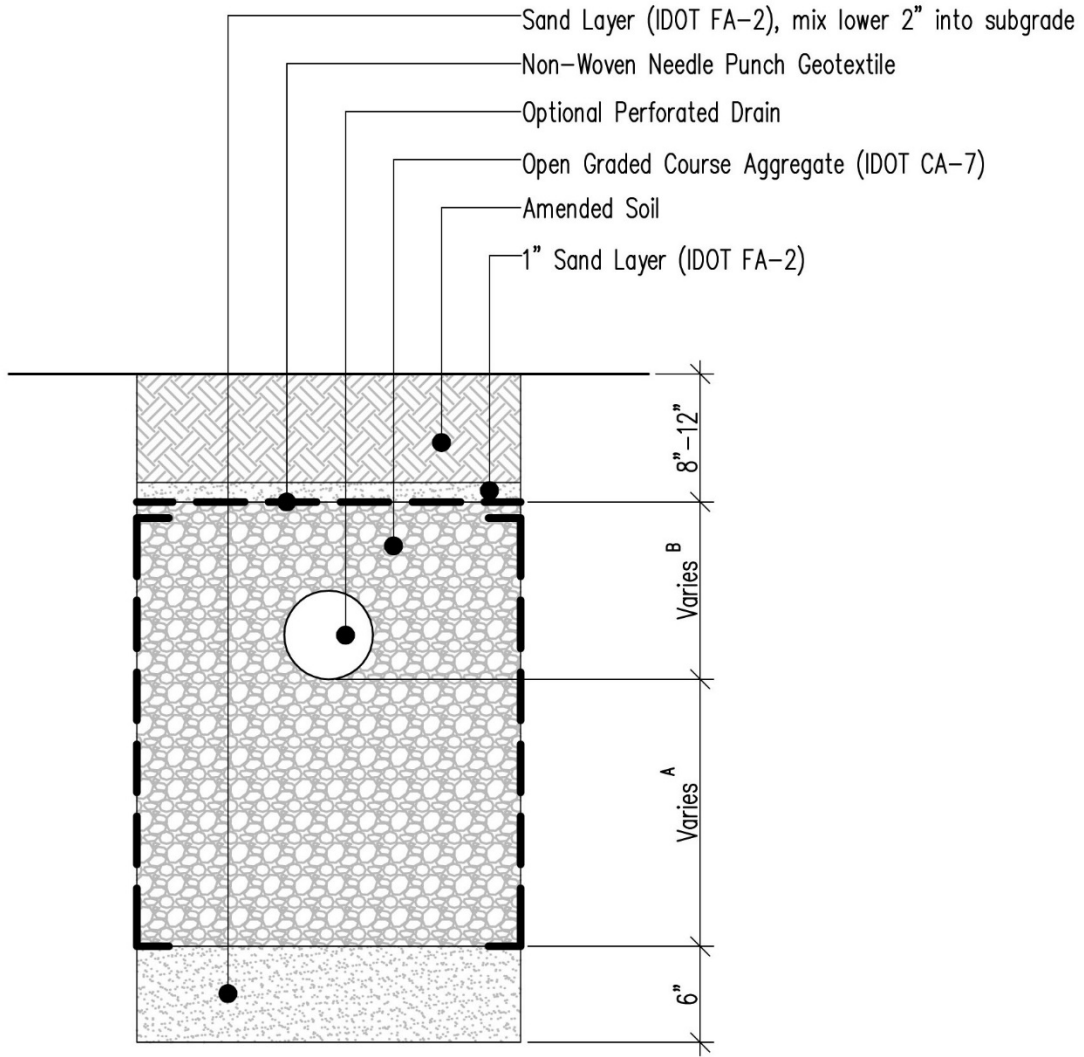

- A) Retention volume (exfiltrated into soils)
- B) Detention volume (drained through perforated pipe)

Note: Duration of ponding shall not exceed 72 hours

## Infiltration trench

Not to Scale

Figure 7 – Infiltration Trench Detail

- <sup>1</sup> Northern Virginia Planning Commission and Engineers and Surveyors Institute (1992); MA Department of Environmental Protection (1997); Lowndes (2000); Los Angeles County Department of Public Works (2002)
- <sup>2</sup> Schueler (1987); Northern Virginia Planning Commission and Engineers and Surveyors Institute (1992); Schueler *et al.* (1992)
- <sup>3</sup> Schueler (1987)
- <sup>4</sup> Schueler (1987); Lowndes (2000)
- <sup>5</sup> WDNR (2004b)
- <sup>6</sup> MA Department of Environmental Protection (1997); Lowndes (2000)
- <sup>7</sup> Lowndes, M.A. (2000)
- <sup>8</sup> WDNR (2004a)
- <sup>9</sup> MA Department of Environmental Protection (1997)
- <sup>10</sup> Schueler (1987); Horner *et al.* (1994); EPA (1998); Barr Engineering Company (2001)
- <sup>11</sup> WDNR (2004b)
- <sup>12</sup> Mahabadi (2001)
- <sup>13</sup> Schueler (1987); Lowndes (2000)
- <sup>14</sup> Mahabadi (2001)
- <sup>15</sup> Schueler (1987); Horner *et al.* (1994); EPA (1998); Barr Engineering Company (2001)
- <sup>16</sup> Schueler (1987); Northern Virginia Planning Commission and Engineers and Surveyors Institute (1992); Lowndes (2000)
- <sup>17</sup> Lowndes, M.A. (2000)
- <sup>18</sup> Northern Virginia Planning Commission and Engineers and Surveyors Institute (1992)
- <sup>19</sup> Mahabadi (2001)
- <sup>20</sup> Mahabadi (2001)
- <sup>21</sup> Northern Virginia Planning Commission and Engineers and Surveyors Institute (1992); MA Department of Environmental Protection (1997); Los Angeles County Department of Public Works (2002); WDNR (2004b)
- <sup>22</sup> WDNR (2004b)
- <sup>23</sup> Mahabadi (2001)
- <sup>24</sup> MA Department of Environmental Protection (1997)
- <sup>25</sup> MA Department of Environmental Protection (1997)
- <sup>26</sup> Northern Virginia Planning Commission and Engineers and Surveyors Institute (1992)
- <sup>27</sup> Lowndes (2000)
- <sup>28</sup> Northern Virginia Planning Commission and Engineers and Surveyors Institute (1992)
- <sup>29</sup> Northern Virginia Planning Commission and Engineers and Surveyors Institute (1992); MA Department of Environmental Protection (1997); Los Angeles County Department of Public Works (2002)
- <sup>30</sup> Lowndes (2000)
- <sup>31</sup> Mahabadi (2001)

- Barr Engineering Company (2001), Minnesota Urban Small Sites BMP Manual Stormwater Best Management Practices for Cold Climates, Metropolitan Council Environmental Services.
- Los Angeles County Department of Public Works (2002), Development Planning for Storm Water Management: A Manual for the Standard Urban Storm Water Mitigation Plan (SUSMP).
- Lowndes, M.A. (2000), The Wisconsin Storm Water Manual: Infiltration Basins and Trenches (G3691-3). Wisconsin Department of Natural Resources, Madison, Wisconsin.
- MA Department of Environmental Protection (1997), Stormwater Management, Volume Two: Stormwater Technical Handbook.
- Mahabadi, Mehdi (2001), Regenwasserversickerung, Planungsgrundsätze und Bauweisen. Thalacker Medien.
- Northern Virginia Planning Commission and Engineers and Surveyors Institute (1992), Northern Virginia BMP Handbook: A guide to planning and designing best management practices in Northern Virginia.
- Schueler, T.R. (1987), Controlling Urban Runoff: A Practical Manual for Planning and Designing Urban BMPs. Department of Environmental Programs, Metropolitan Washington Council of Governments, Washington, D.C.
- Schueler, T.R., Kumble, P., and Heraty, M. (1992), A Current Assessment of Urban Best Management Practices: Techniques for Reducing Nonpoint Source Pollution in the Coastal Zone. Anacostia Research Team, Metropolitan Washington Council of Governments, Washington, D.C.
- Wisconsin Department of Natural Resources (2004a), Site Evaluation for Stormwater Infiltration, Conservation Practice Standard, (1002) 02/04.
- Wisconsin Department of Natural Resources (2004b), Bioretention for Infiltration, Conservation Practice Standard, (1004) 10/04.

## Level Spreader and Filter Strips

### **Definition**

Level spreaders and filter strips represent two separate BMPs that have been combined for more effective stormwater management treatment. The effectiveness of filter strips alone in urban applications is often compromised by concentration of runoff that causes erosion. This problem can be resolved through use of a level spreader that directs runoff evenly over the filter strip<sup>1</sup>. Level spreaders and filter strips can also be combined with other BMPs. They can, for instance, receive discharge from rain gardens, porous pavement areas, and naturalized detention for further treatment, infiltration, and de-concentration of flow.

#### Level spreader:

A level spreader is a device used to dissipate concentrated runoff into uniform surface sheet flow. The concentrated runoff may be received through subsurface structures (such as perforated pipes) or surface structures (such as parking lot curb cuts). The conversion of concentrated flow into sheet flow greatly reduces the risk of erosion and scouring and creates conditions for proper filter strip function. The uniform sheet flow from the level spreader is released to an adjacent filter strip on the downstream side.

#### Filter strip:

The filter strip receives evenly distributed overland sheet flow, typically from either a level spreader or a level pavement edge. The filter strip is sloped such that the overland runoff drains slowly, providing an opportunity for runoff treatment (pollutant removal) and infiltration (surface ground water recharge)<sup>2</sup>. Preferably, filter strips are vegetated with native prairie grasses and forbs that will improve the water quality and infiltration performance of the strip. However, filter strips can be vegetated with turf and still provide a benefit. (Where filter strips are used to offset impervious area, they must be vegetated with native species.)

### **Suitable Applications**

Filter strips can be applied to a variety of urban land uses. They are particularly well suited for residential developments<sup>3</sup> and campus type commercial and industrial developments. Since these developments usually have large expanses of areas that can readily be planted with native vegetation and used to accept runoff from impervious surfaces or other BMPs. The strips can easily be incorporated into the site layout and landscape designs. However, smaller filter strips can also be used to treat runoff from almost any parking lot.<sup>4</sup>

Vegetated filter strips function best on gradual slopes, ideally less than 5%. Slopes steeper than 15% should be avoided<sup>5</sup>. Only smaller drainage areas (e.g. roadway pavement draining across a vegetated embankment) should be connected to filter strips with slopes of 5% to 15% to prevent erosion and scour of the filter strip.

Urban stormwater systems often produce concentrated discharges that require a level spreader to disperse flows to the filter strip<sup>6</sup>. The level spreader can be applied as a

flow interceptor device at small culverts or other surface discharges to redistribute the flow. Another application is within a filter strip (mid slope) where re-concentrated runoff can be intercepted and redistributed.

In other applications, concentrated runoff is discharged to a perforated distribution pipe within the level spreader trench. The perforated pipe distributes the runoff over the length of the level spreader and the flow wells up out of the trench over the length of the spreader. In many cases, impervious surfaces, such as small parking lots and roads that produce unconcentrated sheet flow can drain directly onto the filter strip with no level spreader.<sup>7</sup>

### **Benefits**

In addition to dissipating energy and distributing the runoff, level spreaders provide cooling of the first flush runoff from high temperature paved or roof surfaces. Filter strips also help to reduce runoff temperature<sup>8</sup> prior to the introduction of excess runoff into local waterways.

The uniform sheet flow of level spreaders and filter strips can provide effective infiltration and filtration. Filter strips with native vegetation serve as effective buffers between developments and sensitive features such as streams, lakes, and wetlands<sup>9</sup>.

Level spreaders and filter strips can reduce both the rate and volume of stormwater runoff on a site. In addition to dispersing concentrated flows, level spreaders can also serve as infiltration trenches (without the vegetated cover), if sized accordingly. The majority of smaller rain events are exfiltrated through the bottom of the trench, whereas larger flows are discharged as sheet flow onto the filter strip. However, it should be recognized that the infiltration performance of level spreaders may be lost over time due to the lack of sediment filtration prior to introducing runoff into the trench.

Filter strips provide a level of rate control by increasing the length of flow paths and reducing the velocity to the primary drainage system<sup>10</sup>. This can reduce runoff volumes by providing greater opportunity for infiltration of runoff into the soil<sup>11</sup>. Well maintained filter strips can be very effective in reducing runoff volumes, particularly when the impervious drainage area is less than two to three times the filter strip area<sup>12</sup>. NIPC<sup>13</sup> found that annual storm runoff volumes could be reduced by up to 40 to 45% with conservatively designed and maintained filter strips.<sup>14</sup>

### **Limitations**

Impervious areas connected to the filter strip should be no more than two or three times the filter strip area to assure runoff filtering and volume reduction unless the flow rates are controlled upstream of the filter. The length of the impervious area (parallel to the flow) should not exceed 200-feet<sup>15</sup>.

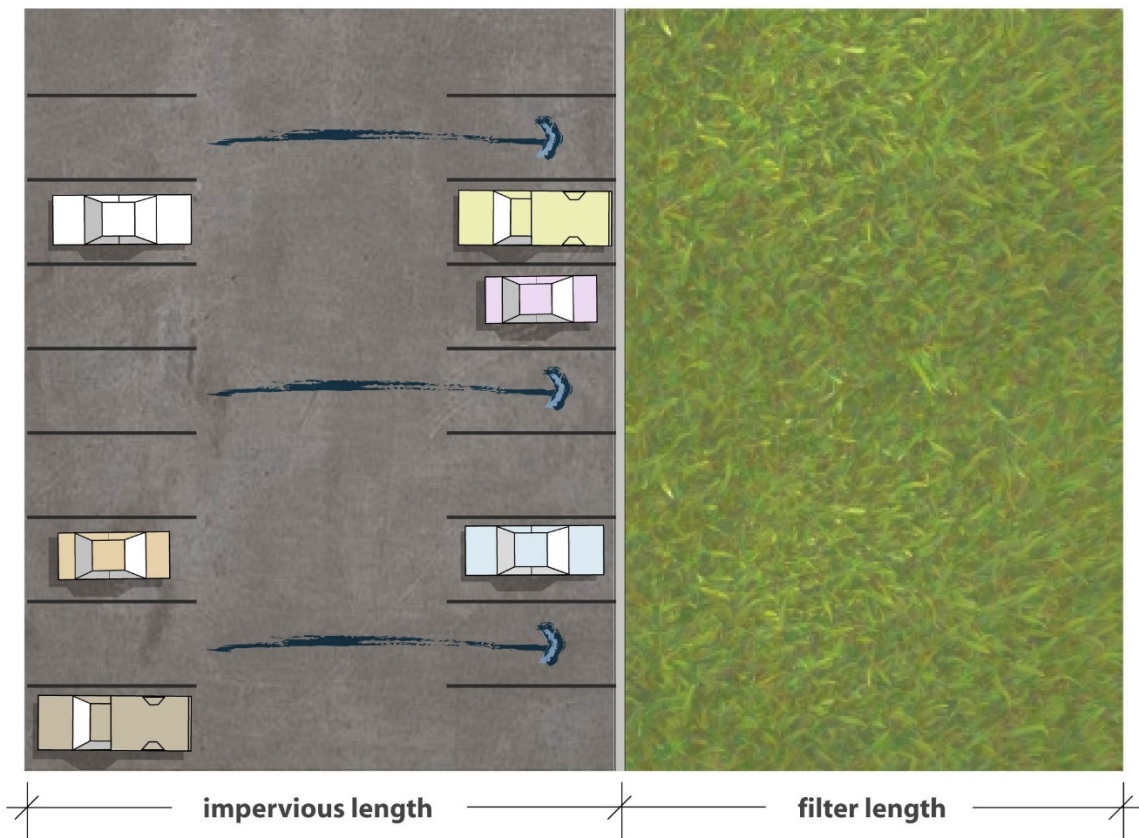

Figure 8 – Filter strip schematic

Filter strips should be located such that they do not conflict with the project site programming and are protected from heavy foot or any vehicular traffic. This will protect the native vegetation and prevents soil compaction<sup>16</sup>.

Filter strips are not suitable for hilly or highly paved areas because of high runoff velocities<sup>17</sup>. Some topographic challenges, however, may be resolved with frequent level spreader placement within the filter strip to intercept re-concentrated flows. The area considered for the filter strip application must be free of gullies and rills<sup>18</sup>.

Areas considered for a filter strip application that will be subject to applications of fertilizers and pesticides are not suitable as filter strips<sup>19</sup>.

Level spreaders and filter strips may not be economically suitable for dense developments with high land values due to the limited availability of space for the filter strip.

### Required Design Data

The ultimate design objective is to maintain evenly distributed sheet flow and very low runoff velocities. Design parameters are the length and slope of the filter, surface area and nature of the drainage area, existing soil types, type of planned vegetation cover,

and runoff velocity<sup>20</sup>. The following data should be collected to inform the design process:

1. Character, geometry, and size of the impervious area tributary to the level spreader and filter strip.
2. Topographic information, including slopes, for the planned filter strip area.
3. Soil type information, from county soil survey to assess erosion risk and type composition of native vegetation mix.

### **Level Spreader Design**

Level spreaders are similar to infiltration trenches. Typical differences include the trench size (level spreaders tend to be smaller) and the trench cover. Level spreaders are not covered with a vegetated amended top soil, but rather with an open graded aggregate (IDOT CA 7).

The primary performance objective of level spreaders is to convert concentrated flows into uniform overland sheet flows. They may further provide nominal retention through runoff exfiltration through the trench bottom.

Level spreader function can, however, be combined with infiltration trench function and sized for Volume Reduction. With this combination, only excess runoff that exceeds the capacity of the infiltration/level spreader trench is released into the adjacent filter strip. It should be recognized that since level spreaders are not protected from sediment by a topsoil filter, they will be more prone to subgrade clogging and the infiltration benefit of the level spreader will be reduced over time.

The minimum depth of the level spreader should be 6-inches<sup>21</sup> when there is no distribution pipe, and the minimum width should be 6- to 12-inches or greater. The level spreader will need to be deeper and wider when it includes a distribution pipe. The bottom of the level spreader trench should be lined with 2- to 4-inches of torpedo sand (IDOT FA 2) vertically mixed into the subgrade. The vertical infiltration trench walls should be lined with a non-woven needle-punched geotextile to prevent migration of the adjacent soils into the open graded aggregate. The overlap between two ends of the fabric should be at least two feet (shingle effect). The level spreader is filled to 2-inches above the surrounding grade and the gravel should extend minimum 6-inches downstream of the trench to protect the downstream lip of the trench from erosion. The trench should be filled with open graded, preferably washed, aggregated (IDOT CA7). A separate piece of non-woven needle-punched geotextile should be placed near the top of the open graded aggregate fill but below the top of the trench as a filter and sediment barrier. This piece can be removed and replaced as part of remedial maintenance if necessary. The remaining depth of the level spreader is filled with the same aggregate (IDOT CA7) as in the lower trench portion.

Runoff can be conveyed into the level spreader through surface flow, or a perforated distribution pipe.

Level spreader surface inflow design:



Parking lots without curbs or with curb cuts and small culverts are examples of the surface discharge option to a level spreader. Parking lots with a level edge and flush curb should not need a level spreader. The surface flow runoff into the level spreader should be free of sediments to prevent clogging of the trench and premature failure. Another surface inflow application is within a filter strip (mid-slope) where re-concentrated runoff is intercepted and redistributed.

Level spreader subsurface inflow design:

Runoff is conveyed to the level spreader through a stormwater sewer pipe that connects to a standard perforated pipe or slot drain in the level spreader. A standard perforated pipe allows runoff to uniformly fill the level spreader trench and overflow at the downstream edge onto the filter strip. A slot drain will drain water out of the slot. The base of the slot drain should be perforated to allow drainage between events. The discharge to the level spreader should be free of sediments to prevent clogging of the trench and premature failure.

It is essential that the level spreader be surveyed level. If a slot drain is used, the rim of the slot that must be level. If a slot drain is not used, the downstream lip of the level spreader trench and the low gravel mound must be level. If grades are such that the full length of the spreader cannot be installed on the same contour, the spreader should be broken into multiple reaches with each reach located on its own contour.

The first pipe reach of level spreader pipe from the inflow pipe (minimum of five pipe diameters or five feet, whichever is less) should be solid pipe with no slot drain. This is necessary to prevent excessive surface discharge at an elbow or tee where there may be significant head loss associated with the change in direction in flow.

Slot drains or perforated pipes within the level spreader should include cleanouts at the ends and at significant changes in direction to allow for maintenance. Cleanouts may also be required at intermediate points for long level spreader lengths. The cleanout covers should be located at a higher elevation than the rim of the level spreader such that hydraulic head will not lift the cap.

Level spreader discharge:

The pipe within the level spreader (slot drain or standard perforated pipe) should be sized for less than 0.1-foot of head loss from the inflow to the end of the pipe under the design flow. If there is greater head loss, the runoff will discharge from less than the full length of the level spreader. Level spreaders should not be constructed on a slope to compensate for a smaller pipe as this will cause most of the flow to discharge at the far end of the spreader during events less than the design event.

The allowable flow rate per foot of level spreader is determined by the downstream slope, the allowable flow velocity on the slope, and the allowable depth of flow on the slope. The flow should not exceed 1-inch<sup>22</sup> in depth during the design event under full vegetative cover, which translates roughly into 0.01 to 0.02 cfs per linear foot of level spreader, depending on slope. Also, to prevent scour, the velocity should not exceed

the allowable velocity for the soil type, vegetation, and slope, assuming dormant season vegetative cover.

### **Filter Strip Design**

The most important design factors for a filter strip are the drainage area tributary to the filter strip, width, length, and slope of the filter, and the permeability of the soils. Filter strips should be designed to promote shallow, slow velocity, sheet flow through the filter to allow for settling and infiltration. The health and density of the vegetation will also significantly affect the in-situ performance of the filter strip<sup>23</sup>.

During growing season storm events, velocities across the strip will be very low which will promote settling and infiltration. However, during the dormant season, when vegetative cover may be less dense and lower height, velocities may be greater but must not exceed the maximum permissible velocity for the soil and vegetation being used on the filter strip<sup>24</sup>.

If at least temporary vegetative cover cannot be established prior to discharge of runoff to the level spreader, erosion control blanket should be applied over the area of the filter strip.

Longitudinal slopes up to 5% are ideal for level spreaders. Such slopes reduce the risk of re-concentrating flows and erosion and gully formation<sup>25</sup>. Slopes of 5% to maximum 15% may be acceptable for shorter flow lengths. Flow lengths can be reduced through placement of additional level spreaders within the filter strip.

#### **Vegetation:**

Native prairie grasses, sedges, and forbs that achieve a good, dense stand at the soil interface are preferred over turf grass and should be the first choice for vegetate filter strips. Prairie vegetation has the distinct advantage of a deep fibrous root system that can significantly enhance infiltration<sup>26</sup>. Native vegetation further reduces maintenance needs compared to turf vegetation and eliminates the introduction of pollutants through turf pesticides and fertilizers.

Furthermore, when the drainage area is relatively large, slopes flatter than 2% could lead to periods of prolonged inundation and difficulty in maintaining healthy turf<sup>27</sup>. Slope concerns are less critical for filter strips planted with prairie vegetation tolerant to temporarily saturated soil conditions<sup>28</sup>.

The filter strip vegetation should be fully stabilized with cover crop and erosion blanket before the contributing impervious surface is created and its runoff directed onto the filter strip<sup>29</sup>.

#### **Filter strip length:**

The required filter strip area and the limitations on flow rates will generally determine the length of the filter strip. However, the maximum length of the filter will be determined by the length over which sheet flow can be maintained. Level spreaders

should be installed every 50-feet of filter strip length on slopes greater than 5% and every 100-feet of filter strip length on slopes 5% or less<sup>30</sup>. Filter strips exceeding 100- to 150-feet without any flow interception and redistribution should be avoided to prevent concentration of flow that naturally occurs as the length of flow increases<sup>31</sup>.

### **Hydraulic and Hydrologic Analysis**

#### **Depth of flow:**

The depth of flow within filter strips should not exceed approximately one inch under full vegetative cover to prevent re-concentration of flow and submergence of the vegetation, which will lead to reduced filter strip effectiveness. The depth of flow within the filter strip will depend on the slope, vegetation, and discharge rate within the filter strip. Because flow depths will be very shallow, retardance should be used to determine the appropriate n-value (see also Table 56 and Figure 911). For shallow flow, under native vegetative cover, retardance A or B should be used, which translates into an n-value of 0.30 or higher for determining the depth of flow.

#### **Level spreader pipe size:**

The perforated pipe located within the level spreaders is intended to distribute the inflow over the length of the level spreader, ensuring uniform discharge over the length of the level spreader. The perforated pipe must be adequately sized such that the head loss from the upstream to the downstream end of the pipe is less than 0.1-feet to avoid concentration of flow at the upstream end.

Growing Season Retardance Factors for Vegetated Swales <sup>1</sup>		
Retardance	Cover	Conditions
A Very High	Cattail Smooth Brome River Bulrush Hard-stem Bulrush	Excellent stand, tall Excellent stand, tall (avg. 30") Excellent stand, tall Excellent stand, tall
B High	Smooth Brome Tall Fescue Alfalfa Native grasses	Good stand, mowed (avg. 12–15") Good stand, unmowed (avg. 18") Good stand, uncut (avg. 15") Good stand, unmowed
C Moderate	Kentucky Blue Grass Red Fescue Redtop Smooth Brome	Good stand, headed (12–18") Good stand, headed (12–18") Good stand, headed (15–20") Good stand, mowed (6–8")
D Low	Kentucky Blue Grass Red Fescue Redtop Smooth Brome	Good stand, mowed (3–4") Good stand, mowed (3–4") Good stand, mowed (3–4") Good stand, mowed (3–4")
E Very Low	Kentucky Blue Grass	Good stand, cut (2" or less)
<p><sup>1</sup> For turf and other low growing grasses, a dormant season retardance factor one less than the growing season factor should be used. For native vegetation and other tall growing vegetation <u>mowed or burned in the fall</u>, a dormant season factor two less than the growing season factor should be used.</p> <p>Adapted from Natural Resource Conservation Service (NRCS)</p>		

Table 5 – Growing Season Retardance Factors for Vegetated Swales

Figure 5.1.6

### Manning's "n" Related to Velocity, Hydraulic Radius, and Vegetal Retardance

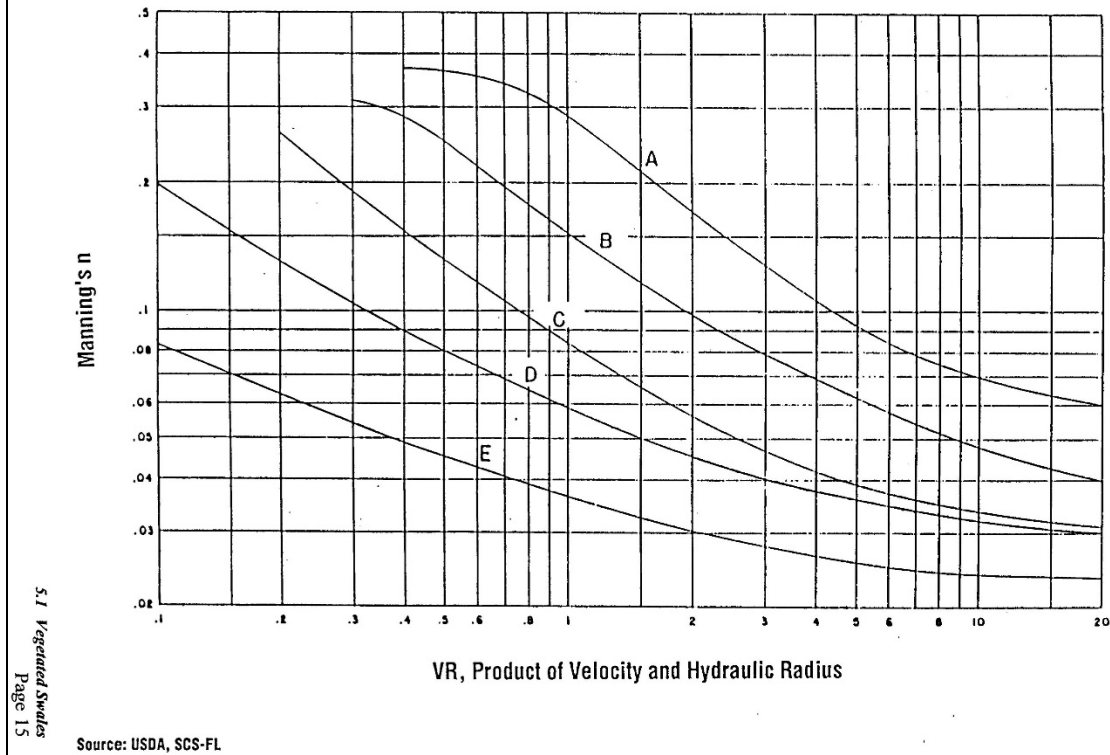

Figure 9 – Manning's "n" Related to Velocity, Hydraulic Radius, and Vegetal Retardance

Maximum permissible velocity:

To avoid scour within the filter strip, the velocity should not exceed the maximum permissible velocity for the slope, vegetation, and soils of the filter strip (see Table 67). For native landscapes, the dormant season, after burn management has occurred, will be the conditions under which retardance will be lowest and the potential for exceeding permissible velocities will be the greatest. Under these conditions, retardance E should be used, which translates into a Manning's n value of 0.08 to 0.10 for shallow flow.

Permissible Velocities for Channels Lined with Vegetation <sup>1</sup>		
Channel Slope <sup>2</sup>	Lining	Permissible Velocity (ft/sec) <sup>3</sup>
0 to 5%	Tall Fescue Kentucky Blue Grass Smooth Brome	4
	Grass-legume mixture Native grass mixture	3
	Red Fescue Redtop	2.5
	Small grains <sup>4</sup>	2
5 to 10%	Tall Fescue	4
	Kentucky Blue Grass Smooth Brome	3
	Grass-legume mixture Native grass mixture	2.5
Greater than 10%	Tall Fescue Kentucky Blue Grass Smooth Brome	2.5
<sup>1</sup> Use velocities exceeding 4 to 5 ft/s only where good cover and proper maintenance can be assured. <sup>2</sup> Slopes greater than 10% should be avoided unless it is for a short distance or the flow rate is low. <sup>3</sup> Cohesive (clayey) fine-grained soils and course grained soils with cohesive fines and a plasticity index of 10 to 40 (CL, CH, SC, and GC) are erosion resistant. Soils that do not meet this criteria should be considered easily erodible. <sup>4</sup> For temporary seedings. Source: IL Natural Resource Conservation Service (NRCS)		

Table 6 – Permissible Velocities for Channels Lined with Vegetation

**Maximum flow rate:**

The maximum flow rate will typically be determined by the allowable maximum depth, slope, and vegetation of the filter strip. However, under some conditions, maximum permissible velocity may control. For native vegetation cover with a Manning’s n of 0.30 and an allowable flow depth of one inch, the flow rate would be 0.01 to 0.02 cfs/foot of level spreader, depending on filter strip slope.

**Construction Considerations**

Sediment laden construction site runoff should not be discharged to the level spreader as it will clog the gravel trench and cause premature failure. Areas where level spreaders and filter strips are to be located should be protected from construction traffic using construction fencing or other barriers to prevent compaction. Maintenance of the soil permeability will both protect the infiltration potential and facilitate the establishment and maintenance of a dense, deep-rooted vegetative cover<sup>32</sup>.

Filter strips should be cleared of stumps, brush, rocks and similar obstacles that may lead to runoff flow concentration. Machinery used to work on the filter strip and level spreaders should be low ground pressure equipment.

Vegetation must be established on the filter strip as soon as possible to prevent erosion and scour. Filter strips should be graded and vegetated early in the construction schedule, preferably before paving increases the rate of runoff. If the latter is impossible, runoff from the hydraulically connected area must bypass the level spreader and filter strip until they are fully stabilized with cover crop and erosion blanket.

### **Operation and Maintenance**

Proper maintenance of the filter strip to prevent loss of vegetation and erosion of the strip may be as important as the initial design. Vegetation should be inspected and replaced as necessary during the first year after construction<sup>33</sup>.

Filter strips and level spreaders should further be inspected for proper distribution of flows and signs of rilling and other erosion during and after major storm events, particularly during the first one or two years. After the first one or two years, the strip and spreader may be inspected annually. If erosion is discovered, the eroded areas should be filled, reseeded, and mulched. Then, the causes for the erosion should be determined and prevented from recurring<sup>34</sup>.

After sufficient graminoid (grasses and sedges) development to provide an adequate fuel source on the filter strip with native prairie vegetation, annual burn management should be implemented. Burning dead plant material reduces weed growth, stimulates native grass and forb growth, and increases nutrients available to the plants. On filter strips where burning is difficult or impossible, the vegetation should be mowed annually in fall or spring. To mimic the burn cycle, all clippings and thatch must be removed after mowing. If the filter strip is mown, low ground pressure equipment should be used to prevent compaction. Mowing should not be conducted under saturated soil conditions to prevent rutting. Note that mowing does not provide the full benefit to native prairie vegetation that fire provides and will often result in a lower ratio of wildflowers (forbs) relative to the grasses.

### **Easement**

The Kane County Stormwater Ordinance requires that stormwater features (such as level spreaders and filter strips) be protected by an easement (Category II) or Declaration of Restriction and Covenant (Category I). All level spreader and filter strip areas that are part of the submitted and approved stormwater management system thus are required to be in an easement. If level spreaders and filter strips are not part of the permitted stormwater management system, such as those installed by a homeowner on his or her own accord, they are exempt from the easement requirement.

## Typical Detail

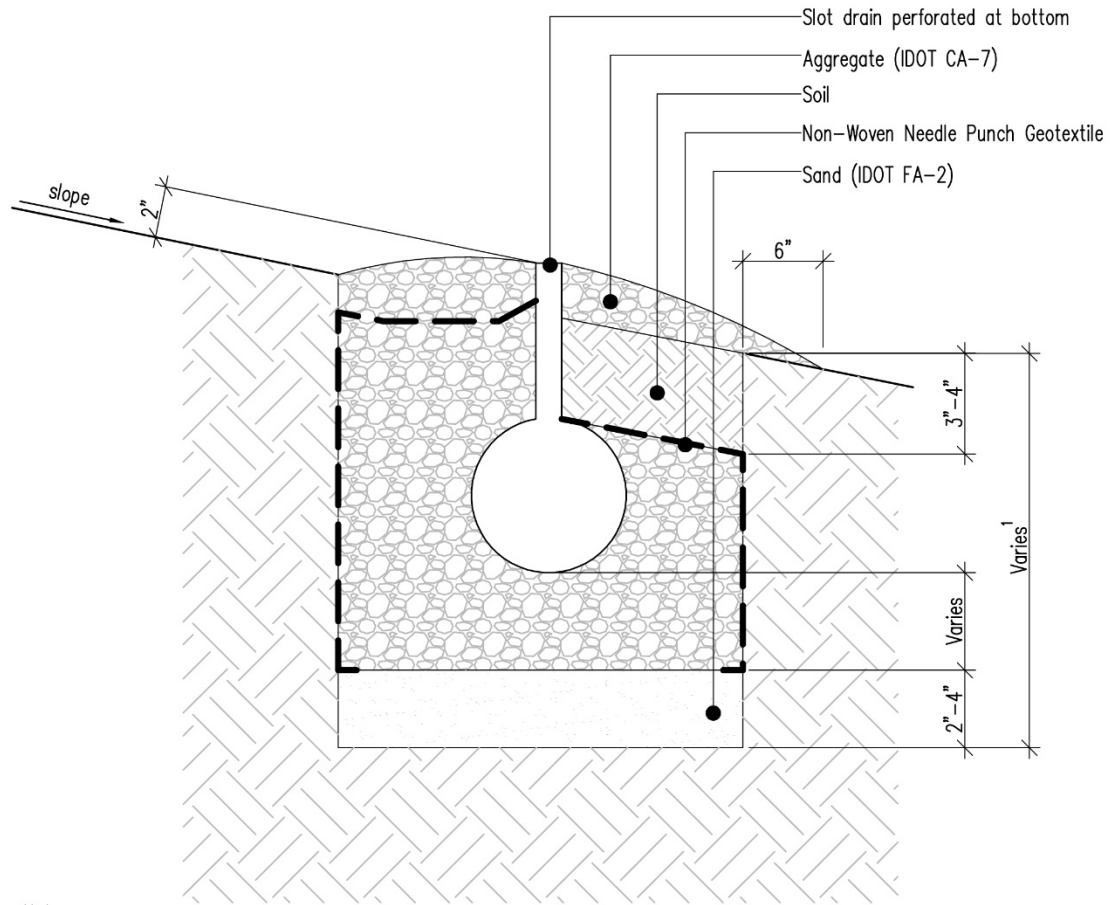

### Notes:

1. Depth shall not exceed that which will drain in 72 hours.

## Level Spreader with Inflow via Slot Drain

Not to Scale

Figure 10 – Level Spreader Detail (with slot drain)



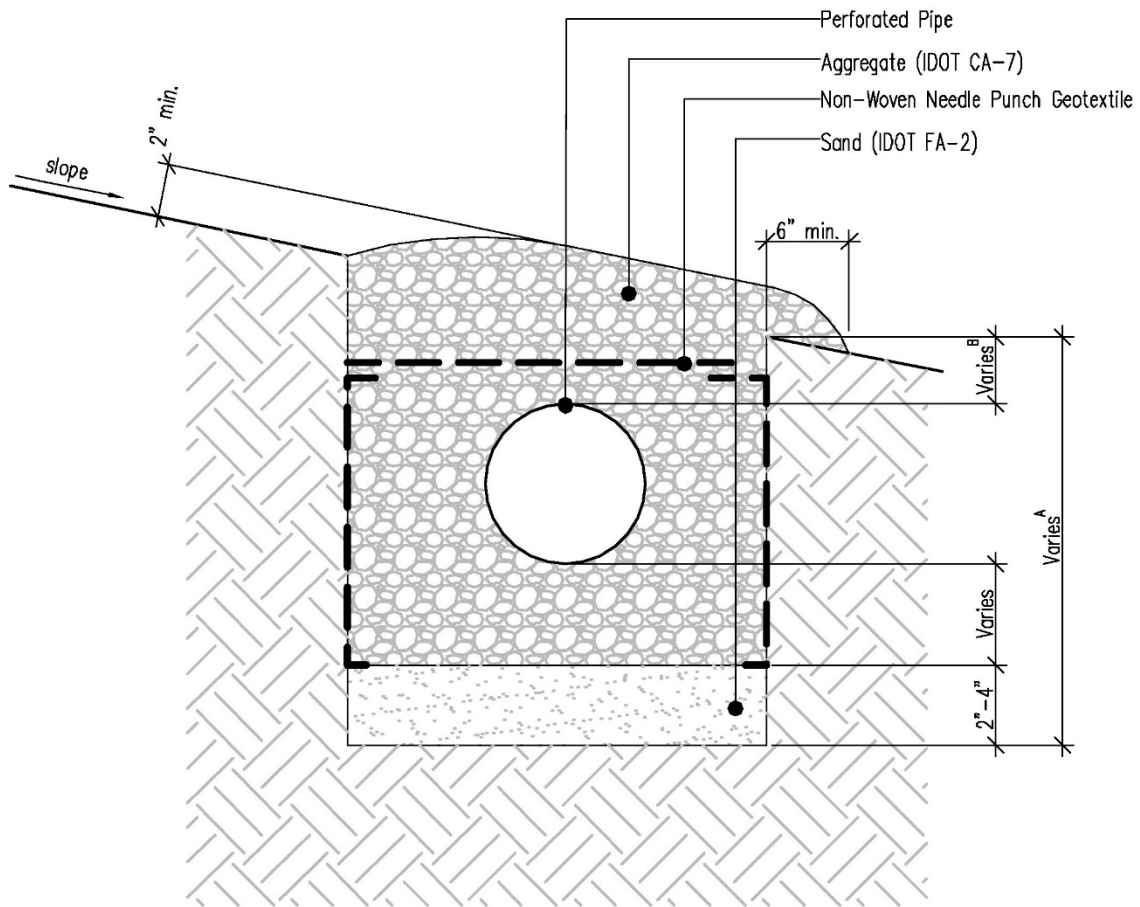

- A) Depth shall not exceed that which will drain in 72 hours.
- B) Perforated Pipe located minimum of one pipe diameter below grade.

### Level Spreader with Inflow via Perforated Pipe

Not to Scale

Figure 11 – Level Spreader Detail (with perforated pipe)

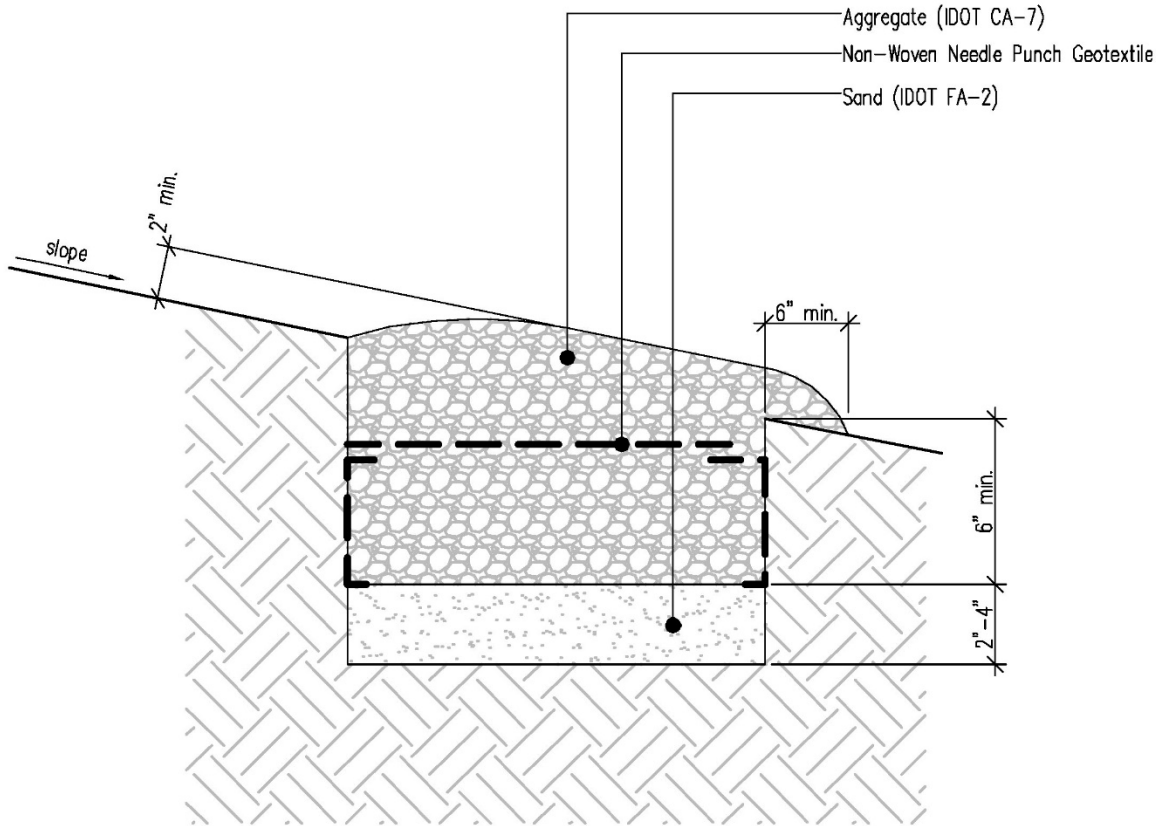

Level Spreader (Flow Interceptor within Filter Strip)

Not to Scale

Figure 12 – Level Spreader Detail (within filter strip (mid-slope))

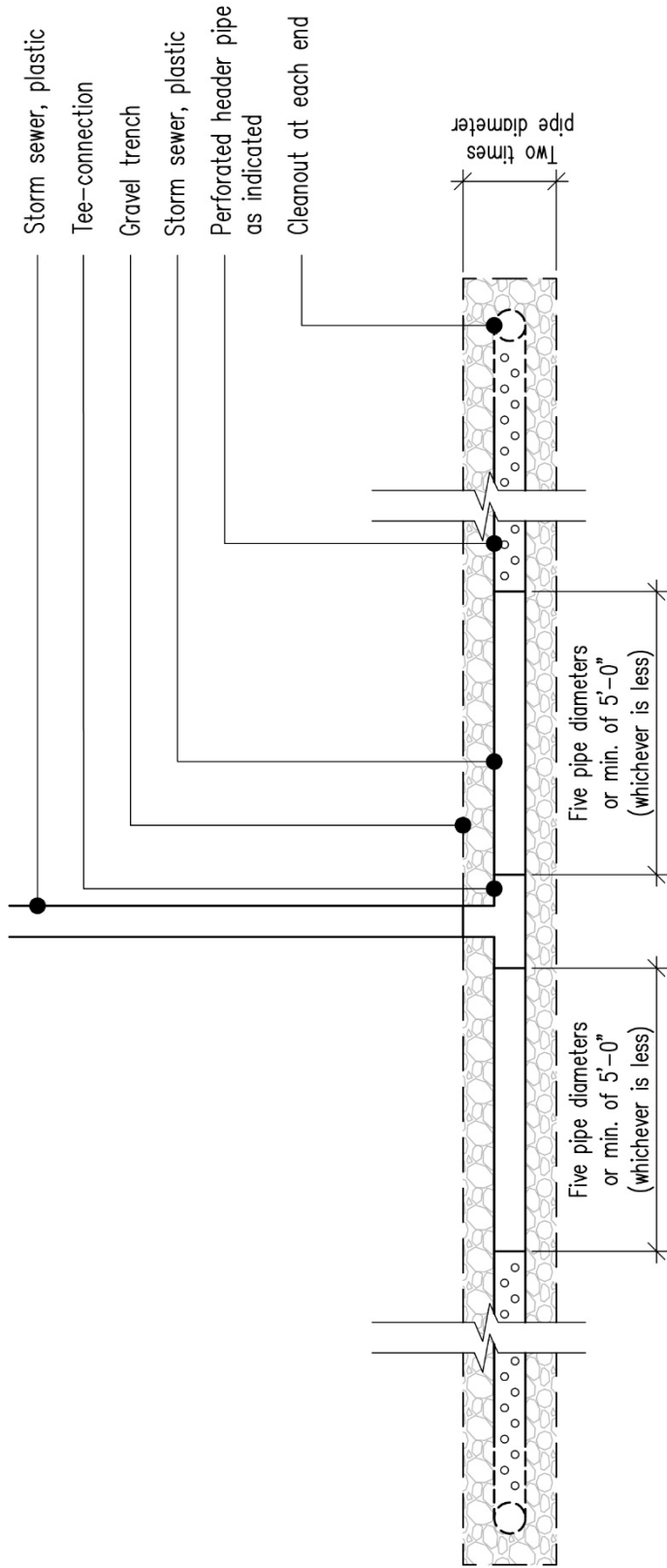

Figure 13 – Level spreader plan view

Level Spreader Plan

Not to Scale

- <sup>1</sup> Yu *et al.* (1992)
- <sup>2</sup> Schueler (1987); Northern Virginia Planning Commission and Engineers and Surveyors Institute (1992); Lowndes (2000)
- <sup>3</sup> Lowndes (2000)
- <sup>4</sup> Price *et al.* (1998)
- <sup>5</sup> Horner (1993); NRCS-II (2001); Los Angeles County Department of Public Works (2002)
- <sup>6</sup> Price *et al.* (1998); NRCS-II (2001)
- <sup>7</sup> Price *et al.* (1998)
- <sup>8</sup> USDA (1994)
- <sup>9</sup> Schueler *et al.* (1992); Price *et al.* (1998)
- <sup>10</sup> Price *et al.* (1998); Lowndes (2000)
- <sup>11</sup> Schueler (1987); NRCS-II (2001)
- <sup>12</sup> Price *et al.* (1998)
- <sup>13</sup> Price *et al.* (1994)
- <sup>14</sup> Price *et al.* (1998)
- <sup>15</sup> Price *et al.* (1998)
- <sup>16</sup> Northern Virginia Planning Commission and Engineers and Surveyors Institute (1992); NRCS-II (2001)
- <sup>17</sup> USDA (1994)
- <sup>18</sup> Schueler (1987)
- <sup>19</sup> Northern Virginia Planning Commission and Engineers and Surveyors Institute (1992)
- <sup>20</sup> Lowndes (2000)
- <sup>21</sup> NRCS-II (2001)
- <sup>22</sup> Minton (2005)
- <sup>23</sup> Price *et al.* (1998)
- <sup>24</sup> Price *et al.* (1998)
- <sup>25</sup> Md DNR ((1984)
- <sup>26</sup> Price *et al.* (1998)
- <sup>27</sup> Price *et al.* (1998)
- <sup>28</sup> NRCS-II (2001)
- <sup>29</sup> NRCS-II (2001)
- <sup>30</sup> Price *et al.* (1998)
- <sup>31</sup> NRCS-II (2001)
- <sup>32</sup> Price *et al.* (1998)
- <sup>33</sup> Price *et al.* (1998)
- <sup>34</sup> Price *et al.* (1998)
- <sup>35</sup> Price *et al.* (1998)

- Bicknell, B.R., Imhoff, J.C., Kittle Jr., J.L., Donigian Jr., A.S., and R.C. Johnson (1993), Hydrologic Simulation Program - Fortran (HSPF): Users Manual for Release 10.0. Aqua Terra Consultants and University of the Pacific, for Environmental Research Laboratory, Office of Research and Development, U.S. Environmental Protection Agency and Office of Surface Water, U.S. Geological Survey. September 1993.
- Dreher, D.W. and Price, T.H. (1997), Reducing the Impacts of Urban Runoff: The Advantages of Alternative Site Design. Northeastern Illinois Planning Commission, Chicago, IL.
- Horner, R.R. (1993), Biofiltration for Storm Runoff Water Quality Control. Prepared for: Washington State Department of Ecology, Center for Urban Water Resource Management, University of Washington, Seattle, WA.
- Los Angeles County Department of Public Works (2002), Development Planning for Storm Water Management: A Manual for the Standard Urban Storm Water Mitigation Plan (SUSMP).
- Lowndes, M.A. (2000), The Wisconsin Storm Water Manual: Filter Strips (G3691-6). Wisconsin Department of Natural Resources, Madison, Wisconsin.
- Maryland Department of Natural Resources (Md DNR), Water Resource Administration (1984), Standards and Specifications for Infiltration Practices. Annapolis, Maryland.
- Minton, G. R. (2005), Revisiting Design Criteria for Stormwater Treatment Systems. Stormwater, March/April 2005, pp.28-43.
- Natural Resource Conservation Service, Illinois (NRCS-II) (2001), Illinois Urban Manual.
- Northern Virginia Planning Commission and Engineers and Surveyors Institute (1992), Northern Virginia BMP Handbook: A guide to planning and designing best management practices in Northern Virginia.
- Price, T.H. and Dreher D.W. (1994), Model Best Management Practice Selection Methodology. Prepared for Lake County Stormwater Management Commission. Northeastern Illinois Planning Commission.
- Price, T.H. and Dreher, D.W. (1998), Urban stormwater best management practices for Northeastern Illinois – Course Notebook. Northeastern Illinois Planning Commission, Chicago, IL.
- Schueler, T.R. (1987), Controlling Urban Runoff: A Practical Manual for Planning and Designing Urban BMPs . Department of Environmental Programs, Metropolitan Washington Council of Governments, Washington, D.C.
- Schueler, T.R., Kumble, P., and Heraty, M. (1992), A Current Assessment of Urban Best Management Practices: Techniques for Reducing Nonpoint Source Pollution in the Costal Zone, Anacostia Research Team, Metropolitan Washington Council of Governments, Washington, D.C.

United States Department of Agriculture (USDA) (1994), Planning and Design Manual for the Control of Erosion, Sediment, and Stormwater.

Yu, S., Kasnick, M, and Bryne, M. (1992), A Level Spreader/Vegetative Buffer Strip System for Urban Stormwater Management. In: Integrated Stormwater Management (Fields, R. et al. editors). Lewis Publishers, Boca Raton, FL.

## Naturalized Stormwater Basins

### Definition

Naturalized stormwater basins, for purposes of this technical manual, are wet detention basins or constructed wetland systems designed to provide greater water quality and habitat benefits relative to standard detention basin designs. Naturalized basin designs consist primarily of constructed wetland systems that consist of a shallow marsh habitat interspersed with open water habitat (less than twenty-four [24] inches). Naturalized stormwater basins also incorporate native vegetation on the side slopes of the basin. Appropriate native vegetation used within a naturalized basin can tolerate inundation and modest water level fluctuations, has deeper root systems to better stabilize side slopes, and typically deters usage of upland areas by geese.

Naturalized stormwater basins can and should be combined with other BMPs in this guidance manual, such as rain gardens, infiltration trenches, and filter strips as pretreatment measures to reduce sediment loads and water level fluctuations within the basin. Level spreaders and filter strips can also be located downstream of the naturalized basin to deconcentrate runoff prior to discharge to a stream or wetland buffer.

### Suitable Applications

Naturalized basins can be applied virtually anywhere that standard basins can be applied. When drainage areas are small, it may be difficult to maintain permanent water and therefore the vegetation may need to be adjusted for small drainage areas and/or for more permeable soils. Since on-stream detention basins are generally not allowed per the Kane County Stormwater Ordinance, this will tend to limit the maximum drainage area to detention basins.

Naturalized stormwater basins are appropriate for residential, commercial and mixed-use developments. The naturalized aspect of these basins is most suitable for an overall landscape plan that is less formal. However, due to their relatively large size, naturalized basins are often located within more formalized landscape plans as well.

### Benefits

Naturalized stormwater basins provide the following benefits:

1. Enhancement of vegetation diversity and wildlife habitat in urban settings<sup>c</sup>.
2. Increased pollutant removal efficiencies due to settling of particulate pollutants and biological uptake by wetland plants<sup>ci</sup>; wet basins are better able to prevent settled pollutants from resuspending and washing out of the basin during subsequent storms<sup>ci</sup>.
3. Downstream environmental benefits include improved water quality, attenuation of runoff rates, and prevention of increased downstream flooding associated with development.
4. Improved aesthetics; can provide value to community open space.
5. Passive recreation opportunities.

6. Relatively low maintenance costs.

### **Limitations**

Naturalized stormwater basins have the following limitations:

1. Large land area requirement for generally single purpose facility (stormwater management).
2. Can be expensive when land costs are considered since detention basins are not as readily integrated into site plans as other BMPs such as permeable paving, rain gardens, and infiltration trenches that typically do not displace developable land.
3. Pollutant removal efficiencies are limited until vegetation is established<sup>ciii</sup>.
4. Less pollutant removal/assimilation during non-growing season<sup>civ</sup>.
5. Potential habitation by undesirable vegetative species if pollutant load and water level fluctuations are not controlled<sup>cv</sup>.
6. Naturalized stormwater basins and other urban stormwater BMPs are typically not intended to address runoff with very high sediment concentrations, such as construction sites, agricultural fields or plant nurseries. However, sediment basins used to address construction site runoff can often be converted to naturalized stormwater basins once the site is stabilized.
7. Naturalized stormwater basins are not a substitute for adequate source controls on manufacturing, industrial, refueling, and other sites where toxic and other pollutants are used or stored.
8. Per the Kane County Stormwater Ordinance, naturalized stormwater basins should not be constructed within natural wetland systems or constructed as on-stream facilities.

### **Required Design Data**

Soil type:

Determine on-site soils within the area proposed for naturalized stormwater basin. If soils are relatively permeable or well drained, such as soil types A and B, it may be difficult to maintain a permanent pool. Usage of a clay liner or adequate compaction of bottom soils may be necessary<sup>cvi</sup>.

Contributing drainage area:

The contributing drainage area and level of imperviousness will determine size requirements to meet the Kane County allowable release rate. The drainage area will also partially determine the ability to maintain a permanent pool of water.

### **Naturalized Stormwater Basin Design**

As previously mentioned, a naturalized stormwater basin can have many variations to its design. The primary features or characteristics that all naturalized basins should include are:



1. Settling feature that also dissipates the energy of incoming flows, such as a forebay, settling basin, or open water area;
2. Slopes (above and below water) that are more gradual than standard detention basins to create greater habitat opportunities;
3. Pool depths (twenty-four [24] inches or less for Volume Reduction credit) that encourage particulate pollutant removal and prevent resuspension;
4. Pool depths (twenty-four [24] inches or less for Volume Reduction credit) that vary to provide a range of habitat opportunities;
5. Native vegetation that is tolerant of the designed hydrologic conditions (depth and duration).

These primary naturalized stormwater basin design features, as well as other design considerations, are further discussed in the following sections.

#### Pretreatment/energy dissipation:

Pre-treatment and/or energy dissipation should be provided at all concentrated discharges to detention basins. An open water forebay provides both energy dissipation and provides an opportunity for settling of the heaviest sediment in an easily maintainable location. The forebay will also prevent scour at the inlet and minimize disturbance of established vegetation during dredging of accumulated sediments. The forebay should be designed following recommendations for settling basins. The NIPC recommendations state that the forebay should be designed with both active storage and a permanent pool. The permanent pool volume should include both treatment volume and sediment storage<sup>cvii</sup>. Please note that while generally the ponding depth in the pond cannot be greater than twenty-four (24") inches in order to receive Volume Reduction credit, the depth requirement does not apply to forebays or outlet micropools.

In general, the forebay should have the following features:

1. Inlet stabilization, such as rip rap, to prevent scour.
2. Length to width ratio that provides a flow path length of at least two to three times the width of the forebay.
3. Side slopes from 6-inches below the NWL to 6-inches above NWL should be 5:1 or flatter to facilitate the establishment of emergent vegetation. Side slopes below this zone should be no greater than 4:1 to prevent potential slope failure and improve safety.
4. The forebay should be located for easy access by sediment removal equipment.
5. The permanent pool volume within the forebay should be sized for treatment as well as sediment storage.
6. The treatment volume should be a minimum 500 cubic feet/impervious acre.
7. The sediment storage volume should be a minimum 100 cubic feet/impervious acre. For a stabilized watershed, this should provide for approximately 10-years of sediment storage.

8. The forebay should be designed with a minimum depth of 3-feet to prevent resuspension of sediments.
9. To distribute discharge from the forebay, a 1-foot high berm of rip rap should be installed between the forebay and the constructed wetland to create a small amount of active storage. The low berm will prevent scour and act as a level spreader.

#### Basin/marsh depths (below normal water level):

The basin/marsh permanent pool depth can vary based on the desired appearance of the stormwater facility. In general, a basin with permanent pool depths of two feet (2') to three feet (3') may be populated by rooted aquatic vegetation. However, in order to meet the Volume Reduction requirement within the Ordinance, the maximum allowable ponding depth is twenty-four inches (24"). A mixture of emergent, rooted aquatic, and open water zones will provide the greatest habitat and visual diversity.

#### Naturalized stormwater basin configuration:

To minimize short circuiting between the basin inlet(s) and outlet, the basin inflow point(s) should be as far from the outlet structure as possible and the configuration of the naturalized stormwater basin should provide a flow path at least three (3) times longer than the average basin width. This can be accomplished by a basin length to width ratio of 3:1, and/or through the addition of design features such as shallow berms. This will ensure that inflow runoff is distributed throughout the basin and there are no stagnant zones. For example, wet basins may include underwater berms that can be designed as emergent shelves and positioned to increase the flow path length. In addition to preventing short circuiting, these emergent shelves can provide habitat opportunities. Increasing emergent shelf area also increases runoff water/soil substrate contact area, improving water quality.

#### Slopes:

The side slopes at the shoreline, from twelve inches (12") above to twelve inches (12") below the NWL, should be no steeper than 10:1. The flatter the slope is graded, the greater the potential for vegetation establishment and habitat opportunities. The side slopes above the shoreline should be 5:1 to facilitate establishment of native vegetation, prevent slumping during drawdown, improve safety, and improve maintainability (e.g. mow management along slope during early stages of plant establishment). Where space is constrained or due to site topography, a 4:1 side slope above the shoreline may be used. At no time should the side slope be designed with a slope steeper than 4:1.

#### Vegetation selection and planting:

Native vegetation should be integrated into the design as much as possible. Certain conditions or situations may warrant use of non-native species, which is discussed in further detail later in this section. Selection of vegetation should consider hydroperiod and light conditions, with preference given to species that are adaptable to the broadest ranges of depth, frequency, duration of ponding, and at least moderate tolerance to nutrient loads<sup>cviii</sup>. Where possible, water level fluctuation should be

controlled to minimize excessive inundation during the first growing season, particularly after seed installation<sup>cix</sup>. This may be accomplished by delaying the installation of the restrictor until the seeded material has established through a growing season. Delayed installation of the restrictor will require coordination with construction schedules related to installation of impervious cover and may need approval by the regulatory body.

Generally, three to four planting zones can be created based on slope, NWL, and anticipated water level fluctuations. The following tables illustrate water depth planting zones. The given elevation ranges are generalized; the actual design elevation ranges should consider the proposed water fluctuations for the specific stormwater facility, in particular, the 2-year stage elevation. It is not uncommon to have some species overlap between zones. As previously discussed, gradual slopes will provide more microclimate conditions that will favor vegetation establishment and a diversity of vegetation habitats. Given the typically unnatural conditions of a stormwater facility, it is recommended to limit plant species to those that are known to grow in such conditions, are native to Kane County, and are considered less conservative (i.e. those species with a coefficient of conservatism (C value) of 5 or less as described in Plants of the Chicago Region. It is recommended to also refer to the Native Plant Guide for Streams and Stormwater Facilities in Northeastern Illinois and Plants for Stormwater Design Species Selection for the Upper Midwest for selection of species and placement within the stormwater facility (see also References at the end of this Section).

<b>Zone</b>	<b>Elevation Range</b>
Deep Emergent	2" to 24" below NWL
Shallow Emergent	2" above NWL to 2" below NWL
Wetland Fringe	12" above NWL to NWL
Mesic Prairie	> 12" above NWL

Table 7 - General Planting Zones and Water Depth Elevation Ranges

**Emergent Zone:**

The following are recommendations for planting within an emergent zone. Some species are tolerant of deeper water conditions, e.g., 6-24 inches below NWL; these have been identified in the Deeper Emergent category. These emergent species generally should be planted in water depths no greater than 6-inches although most of these identified species will tolerate deeper water depths. Other emergent species prefer shallower water depths, e.g., 2- to 3-inches to mudflat conditions; these species have been identified in the Shallow Emergent category.

The emergent zone should be plugged rather than seeded. Plugging rates may vary depending on budget constraints. The minimum installation rate should be approximately 2-foot on centers. Some species, however, have a slow rate of spread and therefore should be planted at a higher frequency rate. The following table provides several recommended species for the emergent planting zones.

<b>Typical Planting Zone Water Depths</b>	<b>Scientific Name</b>	<b>Common Name</b>
Deeper Emergent: 2" to 6" below NWL	<i>Acorus calamus</i>	Sweet Flag
	<i>Carex lacustris</i>	Common Lake Sedge
	<i>Polygonum amphibium</i>	Marsh Smartweed
	<i>Pontederia cordata</i>	Pickereel Weed
	<i>Sagittaria latifolia</i>	Common Arrowhead
	<i>Scirpus acutus</i>	Hard-stem Bulrush
	<i>Scirpus fluviatilis</i>	River Bulrush
	<i>Scirpus validus creber</i>	Great Bulrush
	<i>Sparganium eurycarpum</i>	Common Bur Reed
Shallow Emergent: 2" above NWL to 2" below NWL	<i>Acorus calamus</i>	Sweet Flag
	<i>Alisma subcordatum</i>	Common Water Plantain
	<i>Bidens cernua</i>	Nodding Bur Marigold
	<i>Calamagrostis canadensis</i>	Blue Joint Grass
	<i>Carex comosa</i>	Bristly Sedge
	<i>Carex hystericina</i>	Porcupine Sedge
	<i>Carex pellita</i>	Wooly Sedge
	<i>Carex stricta</i>	Tussock Sedge
	<i>Carex vulpinoidea</i>	Brown Fox Sedge
	<i>Eleocharis obtusa</i>	Blunt Spike Rush
	<i>Eupatorium maculatum</i>	Spotted Joe Pye Weed
	<i>Glyceria striata</i>	Fowl Manna Grass
	<i>Iris virginica shrevei</i>	Blue Flag
	<i>Juncus effusus</i>	Common Rush
	<i>Scirpus atrovirens</i>	Dark Green Rush
	<i>Scirpus pungens</i>	Chairmaker's Rush
<i>Spartina pectinata</i>	Prairie Cord Grass	

Table 8 - Recommended Species for Emergent Planting Zones

**Wetland Fringe Zone:**

The wetland fringe zone can be installed as a combination of plug and seed material. This zone should be seeded with a cover crop and protected with an erosion blanket. The following provides a list of recommended species for the wetland fringe zone. The specific species identified to be installed within this zone as well as the elevation of the zone will depend on the proposed water fluctuations for the designed stormwater facility. A variety of species that are tolerant of periodic wetness as well as mesic conditions should usually be considered for this fringe zone. If, however, the designed slope for the wetland fringe zone is too steep (3:1 or more), and/or the proposed water fluctuation for the 2-year storm event is greater than 2-feet, an alternative planting scheme may be necessary. Designed planting plans, for these conditions or others that pose severe growing conditions, should focus on usage of a few species that may grow under these constraints. An example would be to seed Creeping Bent as the dominant species within a wetland fringe zone, along with typical annual species, such as Bidens, Rice Cut Grass, and other species typically found along mudflats or eroded slope habitats such as Common Water Horehound, Spike rushes, etc.

Typical Planting Zone Water Depths	Scientific Name	Common Name
Wetland Fringe: 12" above NWL - NWL	<i>Actinomeris alternifolia</i>	Wingstem
	<i>Agrostis alba palustris</i>	Creeping Bent
	<i>Asclepias incarnata</i>	Swamp Milkweed
	<i>Aster novae-angliae</i>	New England Aster
	<i>Aster simplex</i>	Panicled Aster
	<i>Bidens cernua</i>	Nodding Bur Marigold
	<i>Calamagrostis canadensis</i>	Blue Joint Grass
	<i>Carex cristatella</i>	Crested Oval Sedge
	<i>Carex stipata</i>	Common Fox Sedge
	<i>Elymus virginicus</i>	Virginia Wild Rye
	<i>Eupatorium perfoliatum</i>	Common Boneset
	<i>Helenium autumnale</i>	Sneezeweed
	<i>Helianthus grosseserratus</i>	Sawtooth Sunflower
	<i>Juncus dudleyi</i>	Dudley's Rush
	<i>Juncus torreyi</i>	Torrey Rush
	<i>Leersia oryzoides</i>	Rice Cut Grass
	<i>Liatris pycnostachya</i>	Prairie Blazing Star
	<i>Liatris spicata</i>	Marsh Blazing Star
	<i>Lobelia siphilitica</i>	Great Blue Lobelia
	<i>Lycopus americanus</i>	Common Water Horehound
<i>Lythrum alatum</i>	Winged Loosestrife	
<i>Mimulus ringens</i>	Monkey Flower	
<i>Panicum virgatum</i>	Switch Grass	
<i>Penthorum sedoides</i>	Ditch Stonecrop	

	<i>Physostegia virginiana</i>	Obedient Plant
	<i>Pycnanthemum virginianum</i>	Common Mountain Mint
	<i>Rudbeckia laciniata</i>	Wild Golden Glow
	<i>Rudbeckia subtomentosa</i>	Sweet Black-eyed Susan
	<i>Scirpus cyperinus</i>	Wool Grass
	<i>Scirpus pendulus</i>	Red Bulrush
	<i>Silphium perfoliatum</i>	Cup Plant
	<i>Solidago graminifolia</i>	Grass-leaved Goldenrod
	<i>Solidago riddellii</i>	Riddell's Goldenrod
	<i>Spartina pectinata</i>	Prairie Cord Grass
	<i>Thalictrum dasycarpum</i>	Tall Meadow Rue
	<i>Verbena hastata</i>	Blue Vervain
	<i>Vernonia fasciculata</i>	Ironweed
	<i>Veronicastrum virginicum</i>	Culver's Root
	<i>Zizia aurea</i>	Golden Alexanders

Table 9 - Recommended Species for Wetland Fringe Planting Zone

Mesic Prairie Zone:

A prairie zone should be established for the remaining slope of the naturalized stormwater basin. The prairie zone will provide additional habitat value, as well as stabilization and filtration functions. The prairie area should also be established using native vegetation. Typically, a mesic prairie seed mix is used for this zone as is provided below. The mesic prairie zone should be seeded at rates standard for the native landscape industry – usually, grasses seeded at eight (8) to ten (10) pounds per acre, forbs seeded at two (2) to three (3) pounds per acre. Applicable cover crop rates should be used based on whether it is installed during the growing season or as a dormant seed installation.

Mesic Prairie	Scientific Name	Common Name
>12" above NWL	<i>Andropogon gerardii</i>	Big Bluestem Grass
	<i>Andropogon scoparius</i>	Little Bluestem Grass
	<i>Aster azureus</i>	Sky-blue Aster
	<i>Aster laevis</i>	Smooth Blue Aster
	<i>Aster novae-angliae</i>	New England Aster
	<i>Astragalus canadensis</i>	Canada Milk Vetch
	<i>Baptisia leucantha</i>	White Wild Indigo
	<i>Bouteloua curtipendula</i>	Side-oats Grama
	<i>Coreopsis palmata</i>	Prairie Coreopsis
	<i>Desmodium canadense</i>	Showy Tick Trefoil
	<i>Echinacea purpurea</i>	Broad-leaved Coneflower

Elymus canadensis	Canada Wild Rye
Heliopsis helianthoides	False Sunflower
Lespedeza capitata	Round-headed Bush Clover
Monarda fistulosa	Wild Bergamot
Panicum virgatum	Switch Grass
Parthenium integrifolium	Wild Quinine
Penstemon digitalis	Foxglove Beard Tongue
Petalostemum purpureum	Purple Prairie Clover
Ratibida pinnata	Yellow Coneflower
Rudbeckia hirta	Black-eyed Susan
Silphium integrifolium deamii	Deam's Rosin Weed
Silphium laciniatum	Compass Plant
Silphium terebinthinaceum	Prairie Dock
Solidago rigida	Stiff Goldenrod
Sorghastrum nutans	Indian Grass
Veronicastrum virginicum	Culver's Root
Zizia aurea	Golden Alexanders

Table 10 - Recommended Species for Mesic Prairie Planting Zone

**Outlet control structure and outlet protection:**

There are various outlet control structures that may be used. A submerged orifice outlet located within a wet basin or within a permanent pool will provide clog protection. It should be noted that the twenty-four inch (24") standard for Volume Reduction ponding depth does not apply to outlet micropools, as the typical micropool should be at least 4-feet deep<sup>cx</sup>. A deeper micropool at the outlet may provide for cooler water discharges that may help to alleviate downstream impacts to temperature sensitive aquatic life<sup>cxii</sup>. The restrictor, which controls the flow rate, should be located at least 1-foot below the NWL.

Outlet protection must be provided for detention discharges to prevent scour. Discharges from a basin that are directed to a stream, lake, or wetland should be directed to the buffer adjacent to the water body rather than to the water body itself<sup>cxii</sup>. The discharge to the buffer must be distributed and the velocity dissipated using a level spreader or other BMPs.

**Maintenance access:**

Maintenance access to the forebay, safety shelf (if applicable), and outflow structure should be provided. Any access routes located on top of berms used to impound the detention volume must be designed and constructed to carry the load associated with maintenance equipment (e.g. small backhoe and dump truck).

**Construction Considerations**

**Soil Preparation:**

Topsoil should be stripped and stockpiled prior to grading. If invasive species or weed seed are expected to be an issue, the top 2-inches of surface soil should be removed/scrapped to remove primary weed seed source prior to stripping of topsoil. The topsoil should be a silt loam based on the U.S.D.A. classification system; uniformly obtained from the A-horizon of the soil profile without admixture of subsoil. Soil compaction should be kept to a minimum within the areas to be planted. If soil compaction occurs or if the soils have a high clay content, the area(s) should be deep disked prior to placement of topsoil.

Stockpiling of topsoil should be kept to a minimum. The longer topsoil is stockpiled, the greater the loss of organic carbon, which is needed for soil fertility and friability. Topsoil should contain 6-10% organic content. At the time of placement, topsoil should be tested for organic content and amended with additional organic matter if the content is less than 6%. The loss of organic carbon will diminish the quality of the topsoil as a growing medium and will affect its ability to absorb runoff.

Topsoil should be spread to a minimum thickness of 6-inches over the entire area to be planted. The topsoil should be blended with the top 2-inches of subsoil to avoid creation of a potential root barrier and to prevent potential slope failure due to slippage at the subsoil/topsoil interface.

#### Timing of Planting/Seeding:

To provide optimal growing conditions and allow the roots to become established prior to warmer and drier conditions, live plantings should be installed in spring prior to June 1st. Planting can occur later, until August 1st, if provisions are made for adequate watering to ensure plant and root establishment.

Seeding may occur in spring, March 1st (or when the soil thaws) through May 31st. Many of the native seeds require moist, cool conditions for germination, which is generally the condition during this time period. A late fall/winter dormant seeding, however, may also be done. A dormant seeding should not occur prior to November 1st, but prior to frozen ground or snow cover conditions. A dormant seeding is more appropriate for those portions of the naturalized stormwater basin that are unlikely to flood and flush the seed from the basin<sup>cxiii</sup>.

#### Erosion and sedimentation control:

Immediately following seed installation of the wetland fringe and mesic prairie zones, a biodegradable erosion blanket should be installed. It is recommended that a double net erosion blanket with a 100% straw matrix can be used from the NWL up to the 2-year stage elevation. A single net erosion blanket with a 100% straw matrix may be used from the 2-year stage elevation up to the top of slope. Clean straw mulch applied at a 2,000 lbs/acre rate and crimped in place may be used instead of an erosion blanket above the 2-year stage elevation. The usage of an erosion blanket or straw mulch has been noted to have benefits that typically outweigh the additional cost factor. These benefits include increased slope stabilization until vegetation is established, seed protection, and enhancement of seedling development.



Predation protection:

Most newly planted areas will need some type of predation protection. Various herbivore predation protection methods are readily available and should be incorporated into the design.

## **Operation and Maintenance**

Annual inspections:

The naturalized stormwater basin should be inspected, at a minimum, twice a year for the first three years after construction, and once a year thereafter. The following items should be noted during each inspection:

1. Presence of erosion rills and gullies, as well as sedimentation deposits.
2. Sediment accumulation within forebay. When the portion of the forebay volume allocated to sediment accumulation is full (typically corresponds to a sediment depth of approximately one foot), removal of sediment is necessary.
3. Vegetation species distribution/survival that includes dominant plant species; presence of installed species within the intended zones and if their aerial coverage has increased; what volunteer species have established and are they considered invasive; and what percent of the naturalized stormwater basin remains unvegetated, excluding designed open water areas.
4. Determine if the depth zones and microtopographic features are still persistent<sup>cxiv</sup>.
5. Inspect the condition of outlet structure – removal of debris or trash that may cause blockages.

From these inspections, various activities may be warranted such as erosion repair through various stabilization methods, clean out debris and trash that may clog the outlet structure, vegetation management of invasive species, removal of accumulated sediments, repair herbivore predation controls, etc.

Accumulated sediment removal:

The frequency of removal of accumulated sediments will depend on the adequacy of soil erosion and sediment control during construction and on the presence of BMPs within the upstream watershed<sup>cxv</sup>. If adequate controls are present, sediment removal may not be necessary for ten (10) years or longer depending upon the designed sediment storage volume. Sediments should be tested prior to removal to determine the appropriate method of disposal.

Vegetation maintenance:

Native vegetation maintenance should include mow management for the first two (2) growing seasons following installation. Mowing should be limited to that portion of the side slope that is less frequently inundated. Mowing frequency and blade height should be adjusted to optimize control of annual and biennial weeds and minimize impact to native perennial species. Generally, mowing for the first full growing season

after installation should begin early May and continue through the growing season at approximately four (4) to six (6) week intervals. The blade height should generally be set at 6- to 8-inches above the ground.

A non-native meadow installation should also be mowed the first growing season following installation at the frequency and blade height specified for the native vegetation. Beginning the second growing season, however, a meadow area should only be mowed once a year after approximately July 15<sup>th</sup> to a height of four (4) to six (6) inches.

Other weed control methods, including spot herbicide treatment and hand weeding, should be employed as necessary to control invasive species. Herbicide treatment should only be performed by a licensed applicator.

Burn management should be implemented as a maintenance activity generally after the third full growing season or as soon as an adequate fuel source is present. Burn management should be used as the primary maintenance activity for the long-term care of the naturalized stormwater basin. Although there are varying opinions as to the recommended frequency of a burn, annual burning will typically remove trash and burnable debris within the facility and reduce the intensity of the fire (potentially less damaging) relative to burns conducted every three to four years (minimum frequency).

Reinforcement plantings:

Reinforcement plantings should be planned and budgeted for implementation after the second or third growing season. Regardless of the care taken during the early stages of development, it is likely that various portions of the initial plantings will not survive. This may be caused by various factors such as predation, drought, various changes in water levels, or other unforeseen factors<sup>cxvi</sup>. The selection of the reinforcement species should be based on information obtained during the site inspections. Species should include those that have persisted and increased in aerial coverage.

### **Easement**

The Kane County Stormwater Ordinance requires that stormwater features (such as naturalized stormwater basins) be protected by an easement. All naturalized stormwater basin areas that are part of the submitted and approved stormwater management system thus are required to be in an easement. If naturalized stormwater basins are not part of the permitted stormwater management system, such as those installed by a homeowner on his or her own accord, they are exempt from the easement requirement.

Typical Detail

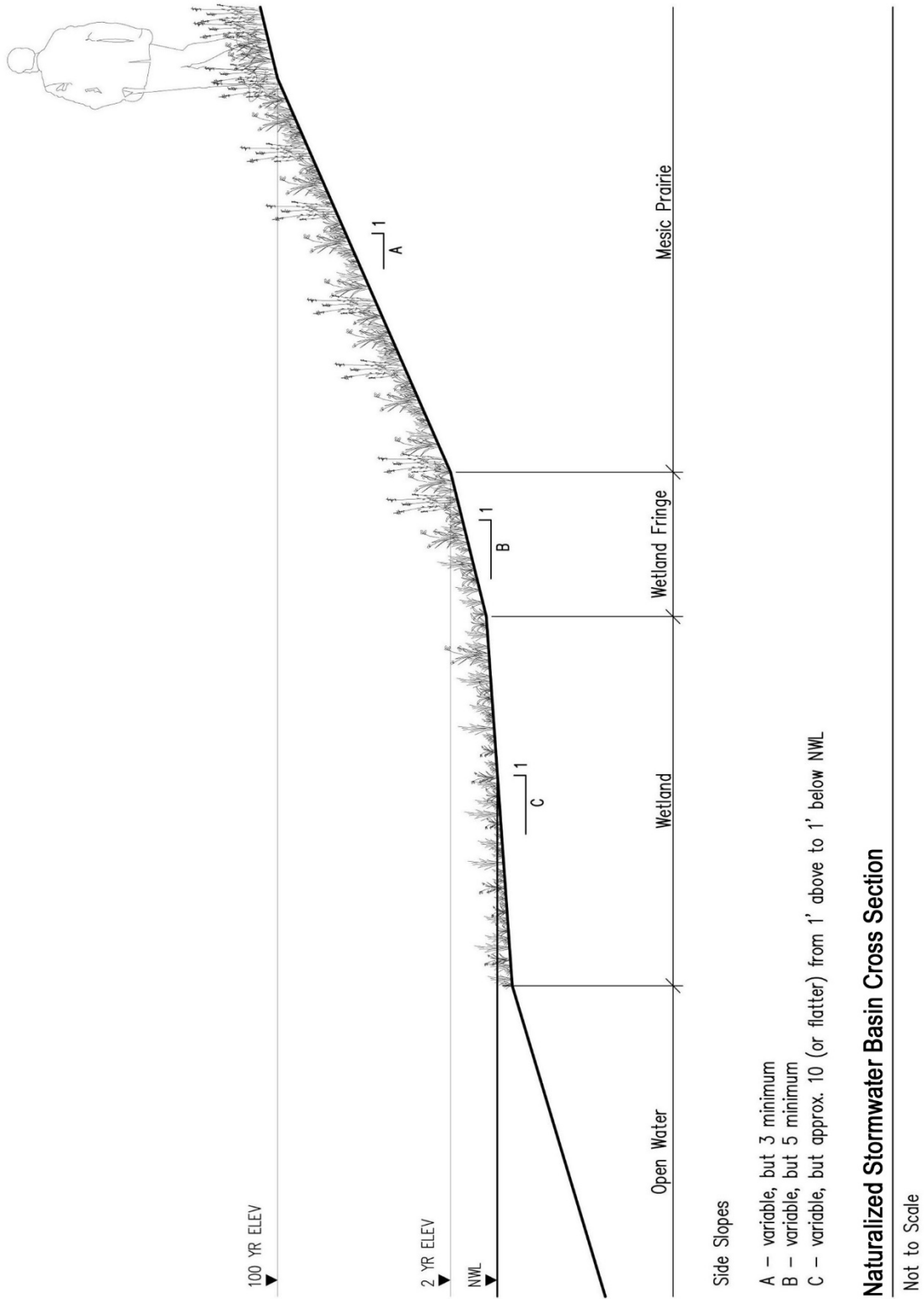

Figure 14 – Naturalized Stormwater Basin Cross Section

- <sup>1</sup> Barr Engineering Company (2001)
- <sup>2</sup> MA Department of Environmental Protection (1997); Barr Engineering Company (2001); Schueler (1992)
- <sup>3</sup> NIPC (2000)
- <sup>4</sup> MA Department of Environmental Protection (1997); Barr Engineering Company (2001); Schueler (1992)
- <sup>5</sup> EPA (1999)
- <sup>6</sup> EPA (1999)
- <sup>7</sup> MA Department of Environmental Protection (1997); NIPC (2000)
- <sup>8</sup> Soil & Water Conservation Society of Metro Halifax (2004)
- <sup>9</sup> NIPC (2000)
- <sup>10</sup> MA Department of Environmental Protection (1997); Barr Engineering Company (2001)
- <sup>11</sup> NIPC (2000)
- <sup>12</sup> Barr Engineering Company (2001)
- <sup>13</sup> EPA (1999)
- <sup>14</sup> NIPC (2000)
- <sup>15</sup> NIPC (2000)
- <sup>16</sup> NIPC (2000)
- <sup>17</sup> Schueler (1992)
- <sup>18</sup> NIPC (2000)
- <sup>19</sup> Schueler (1992)

Barr Engineering Company (2001), Minnesota Urban Small Sites BMP Manual Stormwater Best Management Practices for Cold Climates, Metropolitan Council Environmental Services.

EPA (1999) Storm Water Technology Fact Sheet Storm Water Wetlands.

MA Department of Environmental Protection (1997), Stormwater Management, Volume Two: Stormwater Technical Handbook.

Northeastern Illinois Planning Commission (2000) Urban Stormwater Best Management Practices for Northeastern Illinois.

Schueler, T.R. (1992), Design of Stormwater Wetland Systems, Anacostia Research Team, Department of Environmental Programs, Metropolitan Washington Council of Governments, Washington, D.C.

Soil & Water Conservation Society of Metro Halifax (2004), Stormwater Treatment.

§ T9-108 Requirements for Watershed Benefit Measures

General Requirements

The guidance in this Chapter provides the minimum interpretation of the requirements of the Ordinance as they pertain to Watershed Benefit Measures.

Watershed Benefit Measure Requirements

For certain developments, it may be more feasible to meet the detention storage facility or stormwater mitigation/BMP requirements using a Watershed Benefit Measures. In order to receive credit for Watershed Benefits Measures, developments must meet the requirements noted in Table 9-81 in the Ordinance and must be approved by the Administrator. The allowable watershed benefit measures can vary; however, a list of potential measures can be found on the Natural Resources Conservation Service’s website at the following location:

<https://www.nrcs.usda.gov/wps/portal/nrcs/main/national/technical/cp/ncps/>

For Watershed Benefit Measures, the simple methodology outlined in Investigation of Hydrologic Methods for Site Design in Northeastern Illinois (Dreher and Price, 1991) may be used:

Figure T9-108.A

100-Year Detention Volume vs Percent Impervious  
0.10 cfs/acre Release Rate

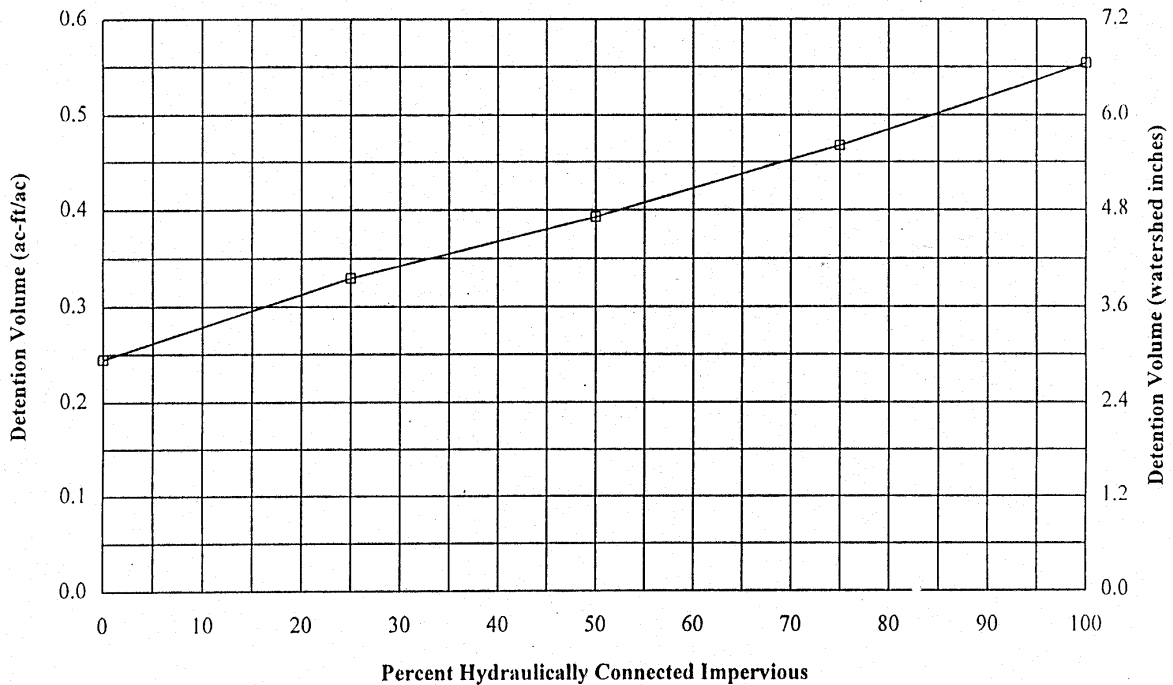

Examples

Table 9-107 of the Ordinance has been provided on the following page. Examples for each row of the table and are provided on the pages following the Table T9-108.A.

Table T9-108.A

Development Category	New Impervious Area for Development or Net New Impervious Area for Redevelopment	Stormwater Mitigation / BMP		Fee-in-Lieu <sup>2</sup> (Section)
		Category I (Section)	Category II (Section)	
Development or Redevelopment	< 5,000 sq.ft <b>See Example T9-107.A.1</b>	X <sup>1</sup> (9-107.C)		A (9-85)
	5,000 sq.ft. – 24,999 sq.ft. <b>See Example T9-107.A.2</b>	X (9-107.C)		A (9-85)
	≥ 25,000 sq.ft. AND < 1% Site area <b>See Example T9-108.A</b>		X (9-107.D)	A (9-85)
	≥ 25,000 sq.ft. AND ≥ 1% Site area <b>See Example T9-107.A.3</b>		X (9-107.D)	A (9-85)
Linear Project (Trails/Roads)	> 1-acre in aggregate for roads and trails that are ≤ AASHTO max. width	X (9-107.C)		A (9-85)
	> 1-acre in aggregate for roads and trails that are > AASHTO max. width <b>See Example T9-107.A.4</b>		X (9-107.D)	A (9-85)
Total Impervious Area > 50% Site area (for Sites < 1-acre) <b>See Example T9-107.A.5</b>		X (9-107.C)		A (9-85)
Hydrologically Disturbed Area > 3-acres			X (9-107.D)	A (9-85)
X = Required; A = Allowed				

<sup>1</sup>Required at the discretion of the **Administrator** where known flooding or drainage issues are in the immediate vicinity of the project, in areas without **Adequate Downstream Stormwater Capacity**, or that outlet to a **Volume Sensitive Watershed**.

<sup>2</sup>Fee-in-lieu requires approval of the **Administrator** and compliance with the requirement listed under Subsection 9-81.B.4.

*Example T9-108*



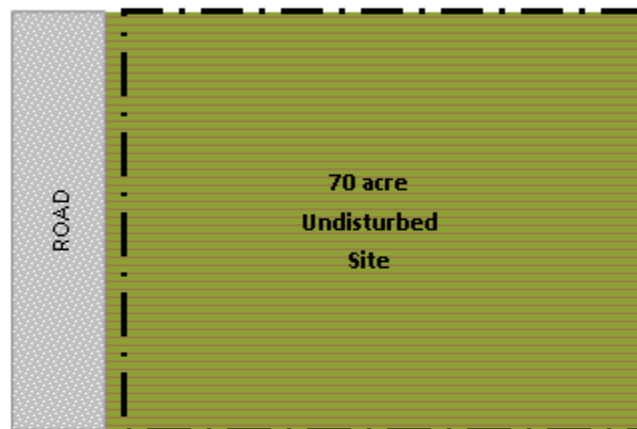

Development of an undisturbed 70 acre agricultural Site with a 25,500 sq. ft. pole barn/driveway with 0.6 acre of Hydrologically Disturbed Area.

Existing Site:

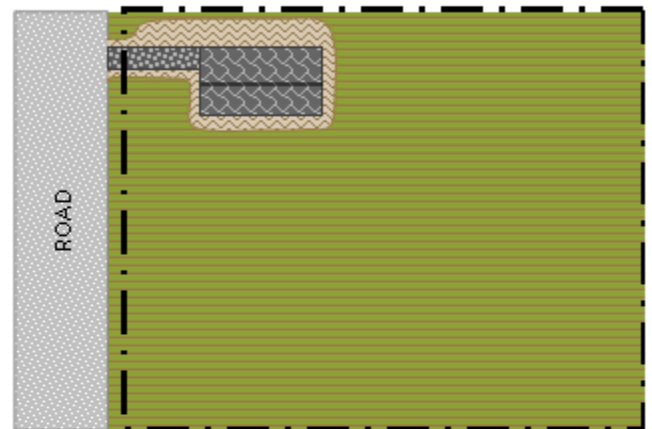

Proposed Site:



-  Existing Undisturbed (not a Hydrologically Disturbed Area) = 70 acres
-  Existing Impervious = 0 sq. ft.
-  Proposed Pervious (Hydrologically Disturbed Area) = 0.25 acre (21,780 sq. ft.)
-  New Impervious Area (Hydrologically Disturbed Area) = 0.58 acre (25,500 sq. ft)

Total Impervious Area =  $0.57 / 70 = 0.008 * 100 = 0.8\%$  of Site area

Detention Required = Yes<sup>1</sup>, > 25,000 sq. ft. New Impervious Area but less than 1% of the Site area

Stormwater Mitigation/BMP = Yes<sup>1</sup>, New Impervious Area > 5,000 sq. ft. and greater than 1% of the Site area

<sup>1</sup>A **Watershed Benefit Measure** may be provided in lieu of the required **Detention Storage Facility** and **Stormwater Mitigation/BMP** at the discretion of the **Administrator**.



Watershed Benefit Measure Volume & Sizing:

Hydrologically Disturbed Area (HDA) Calculations:

$$HDA = P_{HDA} + NI_{HDA}$$

$$0.25 \text{ ac} + 0.58 \text{ ac} = 0.835 \text{ ac}$$

Where:

Proposed Pervious Hydrologically Disturbed Area ( $P_{HDA}$ ) = 0.25 acre

New Impervious Hydrologically Disturbed Area ( $NI_{HDA}$ ) = 0.585 acre (25,500 sq. ft)

Detention Storage Volume Calculations:

$$V_{DSF} = HDA \times V_{UAD}$$

$$0.835 \text{ ac} \times 0.45 \text{ ac-ft} = 0.375 \text{ ac-ft}$$

$$0.375 \text{ ac-ft} \times \frac{43,560 \text{ ft}^2}{1 \text{ ac}} = 16,367 \text{ ft}^3$$

Where:

Percent Hydraulically Connected Impervious = %HCI =  $\frac{NI_{HDA}}{(P_{HDA} + NI_{HDA})} \times 100$

$$\left( \frac{0.585 \text{ ac}}{(0.25 \text{ ac} + 0.585 \text{ ac})} \right) * 100 = 70\%$$

Unit Area Detention Volume ( $V_{UAD}$ ) Determine using Figure below:

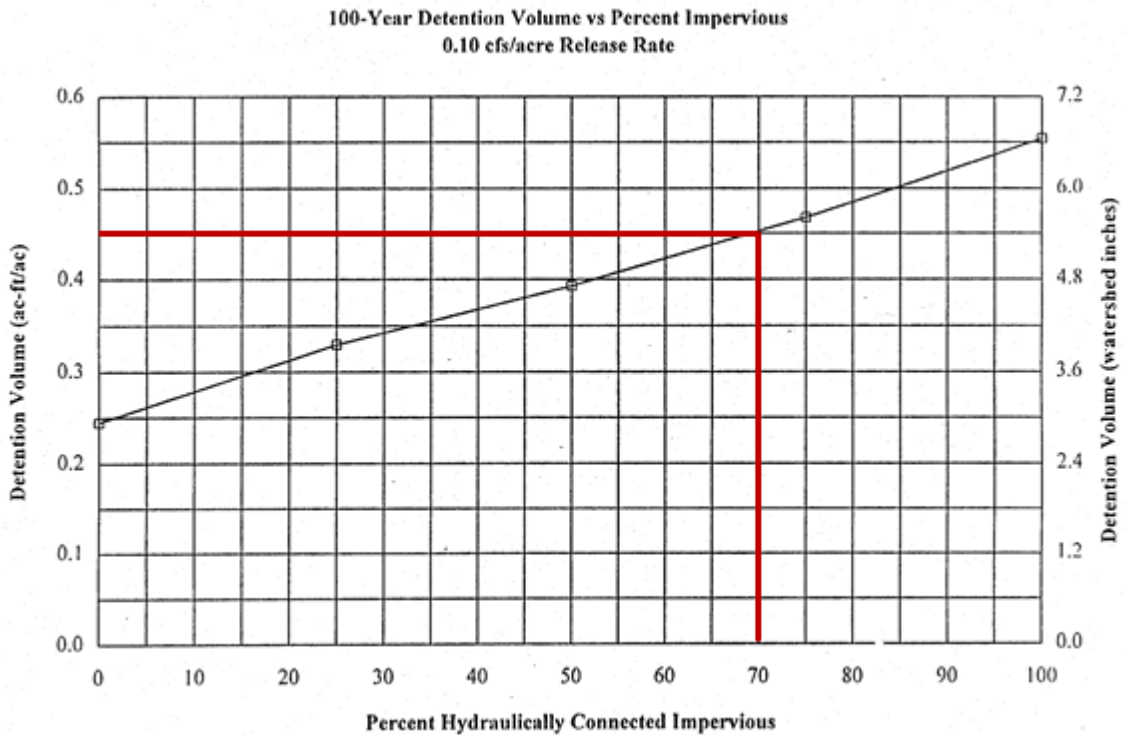

Watershed Benefit Measure Volume & Sizing (continued):

Stormwater Mitigation/BMPs Volume:

$$V_{BMP} = 1in \times NI_{HDA}$$

$$1in \times \frac{1ft}{12in} \times 25,000ft^2 = 2,116.5ft^3$$

Watershed Benefit Measure Volume:

$$V_{WBM} = V_{BMP} + V_{DSF}$$

$$2,116.5ft^3 + 16,367.0ft^3 = 18,483.5ft^3 = \frac{1ac}{43,560ft^2} = 0.42ac-ft$$

The Applicant chooses to provide a Linear Watershed Benefit Measure. Therefore, the required square footage must equal or exceed the square footage of the Detention Storage Facility.

## ARTICLE VI – REQUIREMENTS FOR FLOOD HAZARD AREAS AND BUILDING PROTECTION STANDARDS

### § T9-134 Statewide and Regional Permits

The Ordinance recognizes the general and specific conditions of the Statewide Permits and Regional Permits. For projects which meet the tests for applicability, and can meet the requirements of these permits, no additional requirements of the Ordinance with respect to floodplains apply. The applicant shall send the Administrator documentation that the project complies with a Statewide or Regional permits.

### § T9-135 Floodplain Management

The applicant must identify floodplain limits using the best available information, or the applicant, Director, or Administrator may choose to develop a project-specific floodplain delineation.

The best available information may include reports and studies published by the U.S. Army U.S. Army Corps of Engineers (USACE), the U.S. Department of Agriculture – Natural Resources Conservation Service (NRCS), the U.S. Geological Survey (USGS), the Illinois State Water Survey (ISWS), the Illinois Department of Transportation, Illinois Department of Natural Resources-Office of Water Resources (IDNR-OWR) or the Chicago Metropolitan Agency of Planning (CMAP). The Administrator will need to approve the use of any floodplain study not previously designated as a regulatory study prior to the use of the BFEs, flood profiles or delineations. Applicants should check for the best available information with ISWS Floodplain Repository for BFE data associated with “A Zone” delineations on FEMA maps. Project specific floodplain delineation may require detailed and sophisticated studies. Determining the relationship between the project site and the floodplain is the responsibility of the applicant.

### § T9-136 Floodplain, Regulatory Floodplain, Base Flood Elevation (BFE) and Regulatory Floodway Locations and Standards

Developers must identify all floodplains (regulatory and non-regulatory) on the property proposed for development. Developers also must identify Regulatory Floodway affected by the development. Developers should check with the community official or Administrator to determine if any LOMRs have been published for the development area. Kane County also maintains a listing of applicable regulatory maps within the County or its website. If Regulatory Floodway is shown on a Flood Boundary and Flood Insurance Study or Flood Insurance Rate Map (FIRM) for the project area, it shall also be clearly depicted on site topographic plans.

For projects where no Regulatory Floodplain is shown on the FEMA FIRM, the applicant is responsible for determining the project site BFE. If there is 640 acres (one square mile) or more of upstream tributary drainage area at the outlet point of the site this analysis must be accepted for permitting by IDNR-OWR. The BFE can be determined using a hydrologic and hydraulic (H&H) analysis. Any project-specific floodplain analysis for areas greater than 640 acres may also need to identify a floodway consistent with IDNR-OWR requirements. For project sites with less than 640 acres of upstream tributary drainage area and no riverine Regulatory Floodplain, the Administrator or Director may require a project-specific floodplain analysis.

It should be noted that BFEs which appear on FEMA FIRMs are rounded to the nearest whole foot. It is necessary to consult the FIS flood profiles, which can be read to the nearest 0.1 foot. The flood profile, used in conjunction with site-specific topography, is the definitive floodplain for permitting purposes, but the FEMA mapping is considered definitive for flood insurance and floodway boundaries. If there are inconsistencies, map revisions may be required.

Figure T9-136

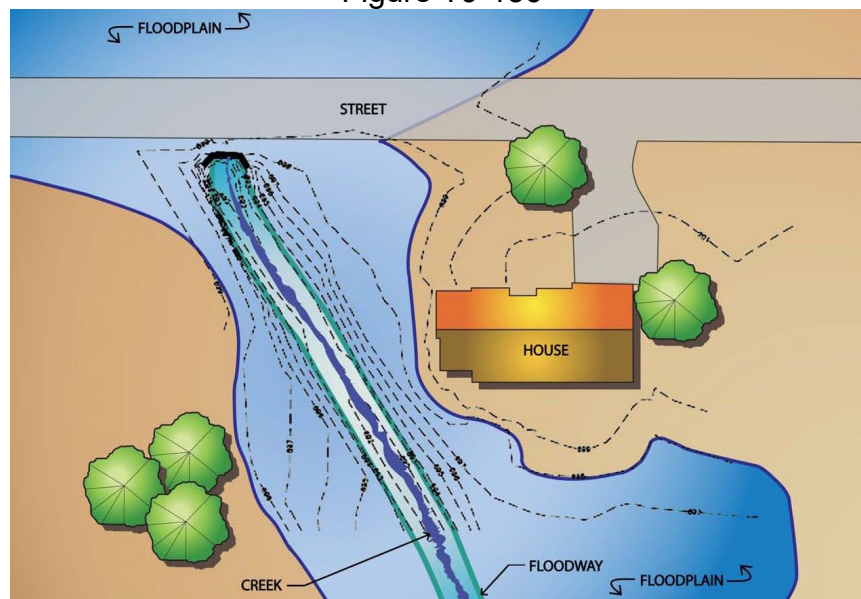

The location of the Regulatory Floodway shall be delineated from the IDNR-OWR designated Regulatory Floodway maps. To locate the floodway boundary, the Regulatory floodway limits should be scaled from the Regulatory Floodway map and transferred to the project site plan using reference marks common to both maps. Typical reference marks are: street intersections, corporate limits, and section lines. It is important that the accurate floodway width be maintained during the data transfer process from the regulatory floodway maps to the applicant's site plan. As with the regulatory floodplain maps, an accurate delineation of the floodway boundary is important to determine the applicable floodway requirements of the Ordinance. The

applicant should then check the floodway location in relation to the stream and the site topography. If it appears that the floodway location is unreasonable, the applicant may wish to pursue a Letter of Map Revision (LOMR) based on improved site topography. The LOMR request is made to FEMA through the IDNR-OWR or its designee and the Director.

An applicant may apply to the Administrator for conditional approval of a site plan with respect to the floodway boundaries prior to finalizing project design. This will provide 1) the Administrator an opportunity to verify the accuracy of the applicant's floodway boundary delineation on the site plan, and 2) the applicant with a level of assurance from the Administrator prior to spending additional time and money on plan and site design.

In the case of property with an elevation higher than the BFE, but located within the regulatory floodway, the property is subject to the regulations of the Ordinance until such time as the LOMR is received from FEMA.

## § T9-139 Building Protection Standards

### Lowest Opening

Proposed structures within or adjacent to the Regulatory Floodplain shall be built with the lowest opening above the FPE, typically two feet above the BFE, unless the structure is within the floodplain or backwaters of the Fox River, which requires three feet above the BFE.

Figure T9-139

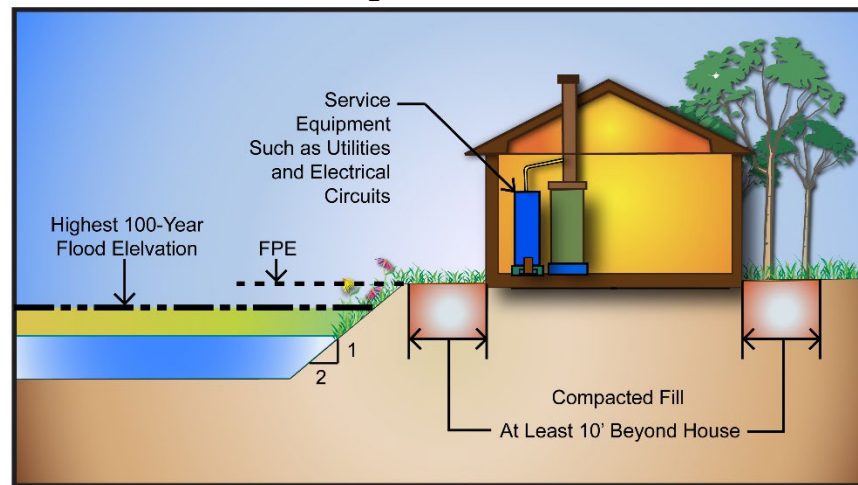
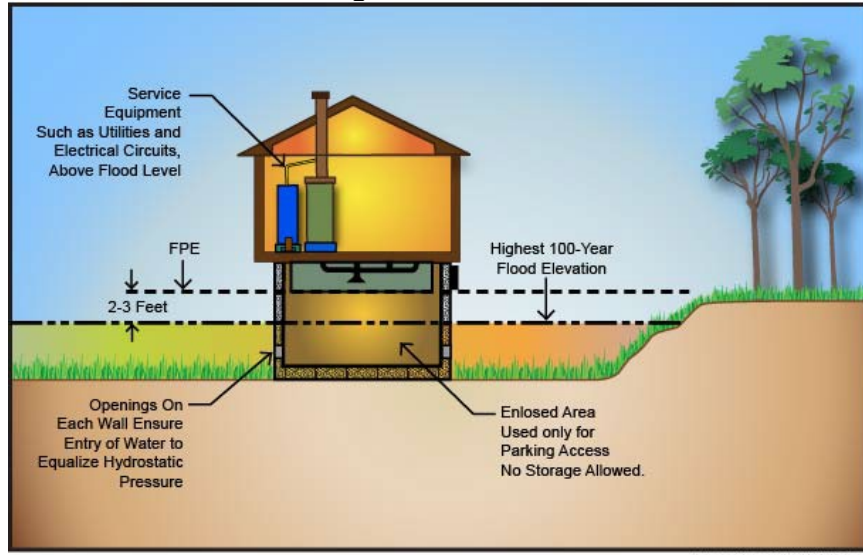
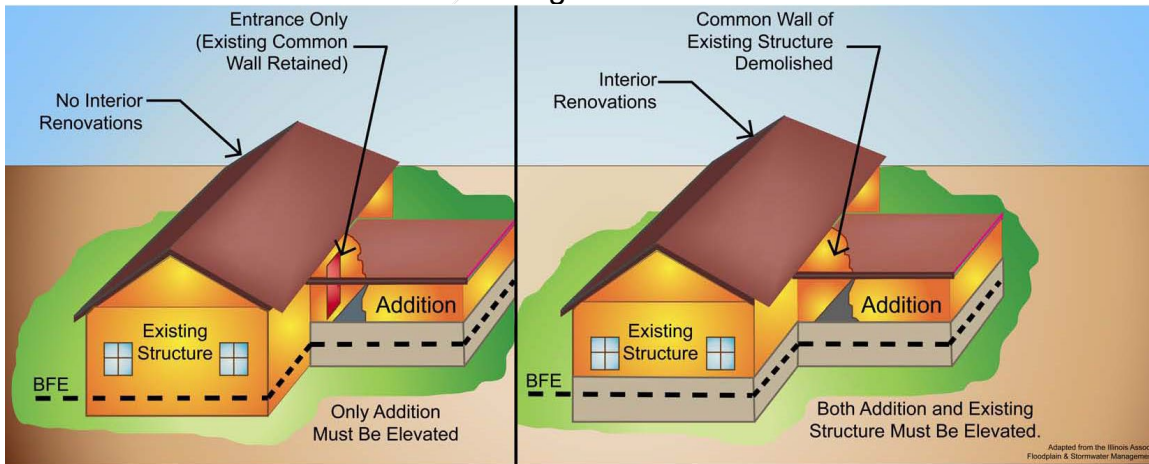

Figure T9-139.B



The Ordinance states explicitly that any new construction or changes to existing structures shall meet the Ordinance requirements. However, the Ordinance does not require that all existing structures located in the regulatory floodplain prior to adoption of the Ordinance be brought into compliance with the current regulations. In the special case of substantial improvement of a structure in the floodplain, the Ordinance requires that the entire structure, both the improvement and the pre-existing portions, be brought into full compliance with the Ordinance. A structure is considered to be improved substantially whenever the improvement exceeds 50 percent of the fair market value of the structure.

Figure 9-139.C



Lateral addition to an existing structure. Addition does not constitute a substantial improvement.

Lateral addition to an existing structure. Addition constitutes a substantial improvement.

## Substantial Improvement/Substantial Damage

The Ordinance stipulates that the lowest floor, including basement, of new or substantially improved residential buildings (altered buildings that increase the first floor area by more than 20%; or manufactured homes), must be elevated above the Flood Protection Elevation (FPE), which is two feet above the BFE. For sites that are located in the floodplain and backwater of the Fox River, the factor of safety is increased to 3 feet above the BFE. The requirement for a minimum elevation in new or substantially improved residential buildings reflects the fact that other floodproofing methods have a poor performance record and may become quite costly.

Substantial Improvement is defined as any, reconstruction, rehabilitation, addition, or other improvement of a structure, the cost of which equals or exceeds 50 percent of the market value of the structure before the start of construction of the improvement.. The term includes structures that have incurred “substantial damage”, regardless of the cause of damage or the cost of the repair work actually performed. However, this term does not include:

- Any project for improvement of a structure to correct existing violation of State or local health, sanitary, or safety code specifications that have been identified by the local code enforcement official, and that are the minimum necessary to ensure safe living conditions, or
- Any alteration of a “historic structure”, provided that the alteration will not preclude the structure’s continued designation as a “historic structure”.

For the purpose of this definition “substantial improvement” is considered to occur when the first alteration of any wall, ceiling, floor or other structural part of the building commences, whether or not that alteration, affects the external dimensions of the structure. See the Substantial Improvement, Substantial Damage and Maintenance Form in Part 2 to determine if a Substantial Improvement is proposed.

Substantial damage occurs when it is determined that the cost of restoring the structure to its before-damaged condition would equal or exceed 50 percent of the market value of the structure before the damage occurred.

For purposes of determining substantial improvement/substantial damage, market value pertains only to the structure in question. It does not pertain to the land, landscaping or detached accessory structures on the property. For determining substantial improvement, the value of the land must always be subtracted.

Acceptable estimates of market value can be obtained from the following sources:

1. Independent appraisals by a licensed qualified professional appraiser.
2. Detailed estimates of the structure's Actual Cash Value (used as a substitute for market value based on the preference of the community) including depreciation.
3. Property appraisals used for tax assessment purposes (Adjusted Assessed Value: used as a screening tool).
4. The value of buildings taken from NFIP claims data (used as a screening tool).
5. "Qualified estimates" based on sound professional judgement made by staff of the local building department or local or State tax assessor's office.

As indicated above, some market value estimates should only be used as screening tools to identify those structures where the substantial improvement ratios are obviously less than or greater than 50% (e.g., less than 40% or greater than 60%). For structures that fall between the 40% and 60% range, the more precise market value estimates list above should be used.

The use of assessed value has some limitations that, if not considered and accounted for, can produce erroneous estimates of market value. These limitations are:

1. Appraisal Cycle: How often are the appraisals done and when was the date of the last appraisal? Market value estimated can be grossly outdated if the cycle is long and the community happens to be in the latter stage of its cycle and has not been appraised for many years.
2. Land Values: In most cases, land values and the value of improvements (structures) thereon will be assessed separately and listed as such on the tax roles. In cases where they are not distinguished, a determination of the value of the land will have to be made and subtracted from the total assessed value.
3. Assessment Level: In Kane County the established statutory ratio between the assessor's estimate of the value and the true fair market value is 33.3%.

In cases where the assessment level is unacceptably low or where the projected ratio of cost of repair to market value is close to 50%, adjustments for assessment level must be made. If the use of assessed value is questioned,



an appeal is warranted, but the burden of proof can be placed on the permit applicant who can be required to submit an independent appraisal by a qualified appraiser.

If a structure is rebuilt in violation of the County's floodplain management regulations and not elevated to or above FPE, the flood insurance rates and premiums will be significantly higher. In addition, the Certified Community can pursue legal action. For substantially damaged structures which have their lowest floors, including basements, several feet or more below the BFE, the annual premium cost increase significantly. The guidance provided here on substantial improvement/substantial damage ~~is~~ is contained in *Answers to Questions About Substantially Improved/Substantially Damaged Buildings* (Federal Emergency Management Agency, FEMA – 213, August 2018).. Additional information can be obtained by consulting this document.

Fill Placed to Elevate a Residential Structure must have the top of the fill and lowest floor, including basement, at or above the FPE. A buffer of fill above the FPE is required for a continuous distance of ten feet out from the building to reduce the potential damages associated with hydrostatic forces on the building. The top of the fill for an attached garage must be 0.5 foot above the BFE. The fill shall not settle below the BFE for a residential structure and not below 0.5 foot above the BFE for an attached garage.

Figure 9-139.D

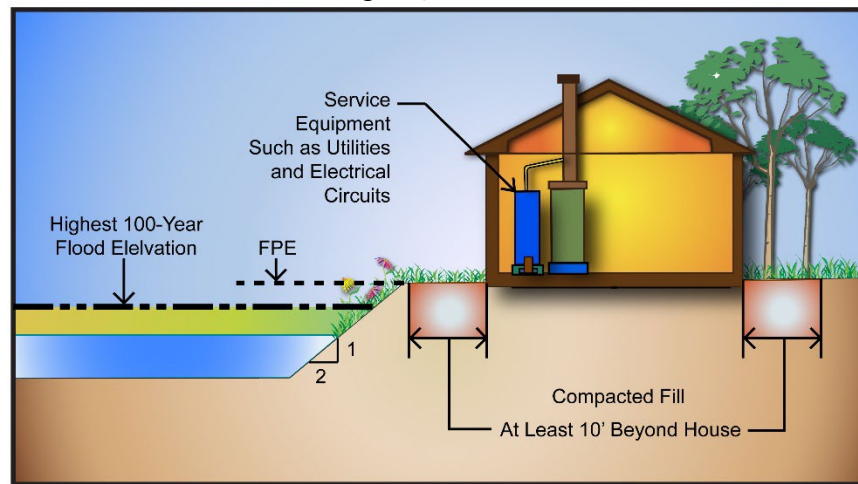

The applicant will need to provide the Administrator with evidence that fill placed to elevate a residential building is protected against erosion and settlement below the FPE. It is strongly recommended that fill be placed in accordance with the FEMA criteria for development. § 65.6 (a)(6) of the NFIP regulations reads as follows:

- (i) Fill must be compacted to 95 percent of the maximum density obtainable with the Standard Proctor Test method used by the

American Society for Testing and Materials (ASTM Standard D-698).

- (ii) Fill slopes for granular materials are not steeper than one vertical on one-and-one-half horizontal unless substantiating data justifying steeper slopes is submitted.
- (iii) Adequate protection is provided for fill slopes exposed to flood waters with expected velocities during the occurrence of the base flood of five feet per second or less by covering them with grass, vines, weeds, or similar vegetation undergrowth.
- (iv) Adequate protection is provided for fill slopes exposed to flood waters with velocities during the occurrence of the base flood of greater than five feet per second by armoring them with stone or rock slope protection.”

Because the flood carrying capacity of the regulatory floodplain must be maintained, fill placed in the regulatory floodplain must be shown to not singularly or cumulatively create a damaging increase in flood heights or velocities or impair the natural hydrologic functions of the floodplain or channel. Therefore, for any development involving fill placement, whether for a building pad or other reasons, the applicant must evaluate the impacts of the fill upon the existing floodplain storage and provide compensatory storage. The requirements for compensatory storage are defined in § T141.

When a residential building is elevated by a means other than filling in the floodplain, restrictions apply to how the structure can be elevated and how the space below the elevated structure may be used. New or substantially improved residential buildings that are elevated by crawl space, walls, pilings or stilts require that the support structure be permanently open below the lowest floor, including basement and not subject to hydrostatic pressures of the base flood. The openings must have a total net area of not less than one square inch for every one square foot of enclosed area subject to flooding below the BFE. These criteria basically allow the area under the elevated structure to be used for storage and conveyance of flood waters. Using this space for flood storage may avoid the need for compensatory storage. The requirements are similar to those of the NFIP and should be familiar to the professional engineer or architect responsible for the design and certification of the permit submittal. The foundation and supporting members must be anchored and aligned in relation to flood flows and adjoining structures to minimize exposure to known hydrodynamic forces such as current, waves, ice, and floating debris. This reduces the risk of structural damage. These considerations are also required by the NFIP regulations. Storage of materials beneath the elevated structures is prohibited. The materials used to elevate the structure, and any other

materials in the space below the elevated structure, must be able to withstand several days of inundation by flood waters without sustaining damage.

Figure T9-139.E shows the required flood protection elevation for a structure being placed on fill and a structure elevated without fill.

FIGURE T9.139.E  
Required Flood Protection Elevation

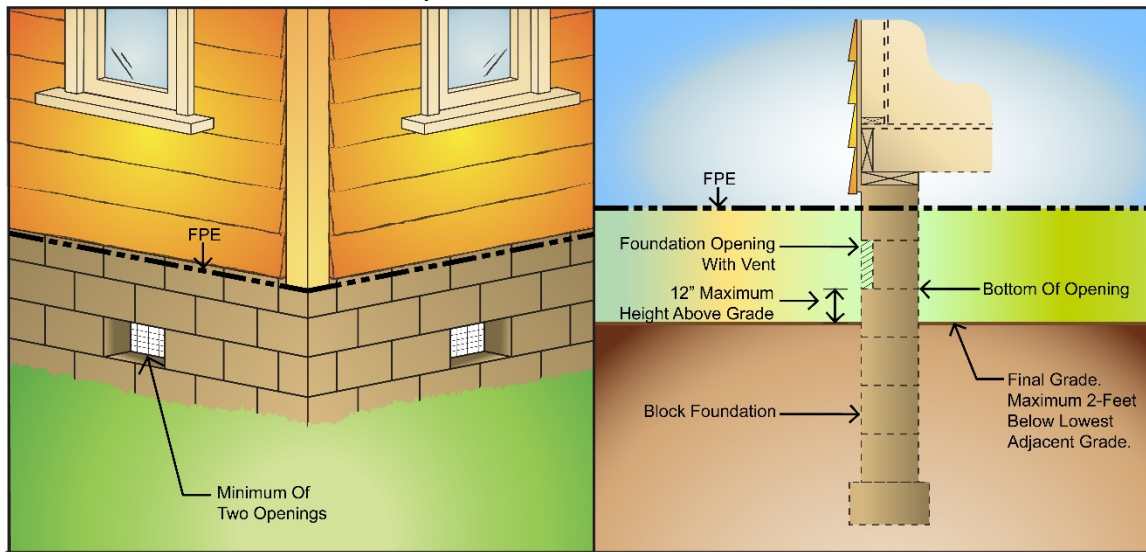

#### § T9-141 Compensatory Storage Volume Standards

Compensatory storage is the replacement of the existing floodplain and, in rare exceptions, the floodway storage lost due to fill. Compensatory storage is required in both riverine and non-riverine floodplain systems. Compensatory storage is required when a portion of the floodplain is filled, occupied by a structure, or a change in the channel hydraulics reduces the existing available floodplain storage. An example is the placement of fill for the construction of a structure. It is important that the natural storage volume be preserved, since it functions like a flood control reservoir to reduce peak flood flows. The Figures on the following page provides an example of compensatory storage and its relationship with the 10-year and 100-year floods.

FIGURE T9-141.A  
Compensatory Storage Example Plan View

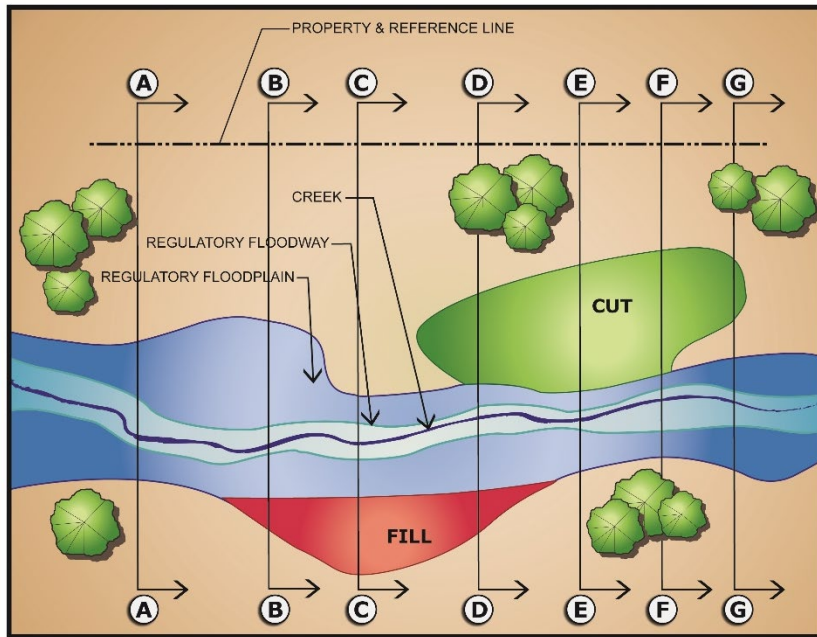

\* Topography not shown for clarity.

Plan View D-D

FIGURE T9-141.B  
Compensatory Storage Example Cross Section View

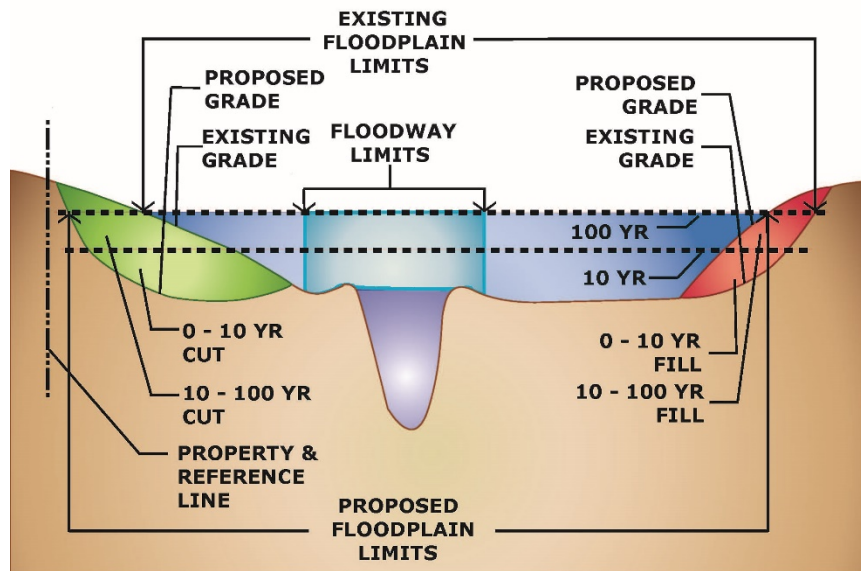

CROSS SECTION D-D

Flood storage is measured between the normal water surface elevation and the BFE for a particular cross-section. Hydraulically equivalent compensatory

storage is storage placed between the proposed normal water surface elevation and the proposed BFE which functions the same as the floodplain volume proposed to be filled. All lost storage below the existing 10-year flood elevation is replaced below the proposed 10-year flood elevation and the storage lost above the existing 10-year flood elevation is replaced above the proposed 10-year flood elevation. It is important that the distinction between existing and proposed water surface elevations be maintained, since large scale regrading of the floodplain by excavation and fill will often result in a change in flood elevation for a given flood frequency. Isolated areas of minor fill in the floodplain will not normally change the flood profile of streams with larger drainage areas, so the existing and proposed flood profiles may be the same.

The Ordinance requires that the compensatory storage for fill or structures in the floodplain. The ratio of compensation storage is based upon the type of development and the extent of hydrologic and hydraulic modeling performed.. The increment of storage compensated over 100% may be at any elevation below BFE and above normal water surface elevation, as long as at least 100% of the lost storage increment between the existing normal water surface elevation and the existing 10-year flood elevation, and between the existing 10-year flood elevation and the existing BFE, is replaced within the respective proposed flood elevations.

Compensatory storage required for Non-riverine floodplain fill, bridge, roadwork or public trail projects, streambank stabilization or restoration projects need to be replaced with compensatory storage at the rate of one to one, between the normal water surface elevation and the BFE.

When developing a grading plan to provide compensatory storage, the Ordinance provisions concerning channel modifications, grading transitions, and buffers must also be followed. The compensatory storage should be located adjacent or opposite the site of the fill, but must also comply with the other Ordinance provisions. This requirement will often limit the extent to which a floodplain may be filled at a particular location.

Where regulatory floodways are mapped, the compensatory storage must be contained within the proposed floodway boundaries. Shifting of the floodway boundaries outside of the existing floodway may be permissible as a way of providing floodway compensatory storage, but all other provisions of the Ordinance regarding floodplains and flood easements must be met and both IDNR-OWR or its designee and FEMA must approve the floodway boundary change. Hydraulically equivalent compensatory storage for fill in the floodway associated with roadway crossings shall meet the same requirements stated above. Artificially created storage upstream of a restrictive bridge or culvert need not be replaced, provided that damages will not occur downstream. Normally, regulatory flows are not attenuated by restrictive stream crossings

and are therefore unchanged upstream and downstream of the restrictive crossing. The floodplain downstream of the crossing should be reviewed to determine whether structures are damaged. If it appears that there is a risk of additional damage, a detailed hydrologic investigation should be performed to establish the extent to which the artificial storage decreases flood flows and to determine what damages might be incurred.

For riverine floodplains, or any floodplain with a regulatory floodway, calculations for floodplain volume submit calculations in tabular form showing calculations by cross-section. The volume of floodplain storage under the without-project conditions and the with-project conditions should be determined using the average end-area method with plotted cross-sections.

Floodplain storage cross-sections should be prepared as follows:

1. Cross-sections should be located parallel to each other and perpendicular to a stream reference line shown on the grading plan. The cross-sections used in the hydraulic analysis should be located perpendicular to flood flows and may not be suitable for volumetric calculations.
2. All cross-sections should be plotted at the same standard engineering scale and should be at a horizontal:vertical ratio of between 5:1 and 10:1.
3. The scale chosen should be large enough to show the intent of the proposed grading.
4. Cross-sections should reflect both the existing and proposed conditions on the same plot.
5. All cross-sections should show the normal water level and the 100-year flood elevation. For riverine floodplains, the cross-sections should also include the 10-year flood frequency elevation and where there is a regulatory floodway, the regulatory floodway encroachments should be scaled onto the cross-sections.
6. Cross-section should span the full floodplain and should include all existing and proposed structures.

In non-riverine floodplains, where the grading plan utilizes a one-foot contour interval and the drawing is at a scale of 1"=50' or less, floodplain storage can be effectively calculated by measuring contour areas.

A grading plan of the project site should be provided to show existing and with-project conditions for the following details:

1. Planimetric Data for All Structures and Construction (Including Location and Dimensions);
2. All Property Lines:
3. Certified Elevation Data, Including Ground Contours at Intervals of 2 Feet or less;
4. Location of Drainage and Flood Control Easements; and
5. Location and Orientation of Cross-Sections.

#### § T9-142 Floodway Standards

Development proposed within the regulatory floodway will require hydraulic calculations to analyze the impacts of the development upon the floodway and floodplain. Backwater models such as HEC-HMS, and WSPRO are acceptable models. For simple crossings such as culverts or clear-span bridges, hand calculations such as USGS regression equations or the equations found in the Federal Highway Administration (FHWA) manuals may be sufficient.

#### Appropriate Uses

Development in the floodway must be an appropriate use of the floodway as stated in the Ordinance Section 9-142.A. Only developments classified as an appropriate use are allowed in the floodway.

Modifications to an existing building that would not increase the enclosed floor area of the building below the BFE, and which will not obstruct flood flows are an appropriate use of the floodway and will require a permit from the Certified Community. Allowable modifications include fireplaces, bay windows, decks, patios, and second story additions.

If the proposed development within a regulatory floodway is not an appropriate use under the Ordinance, the development may only take place by revising the regulatory floodway designation on the site. It will be necessary to construct that portion of the project that revised the floodway on the property prior to the initiation of any building construction. In order to do this, the applicant must obtain local government concurrence of the revised floodway and an agreement from the unit local government to maintain it. The FEMA Community Acknowledgement form, to accompany the request for a proposed revision to the floodway is include as Form 11 in the next part of the manual. The maintenance agreement should be a statement from a community official that acknowledges the revised floodway and that the unit of local government will either assume responsibility to operate and maintain any revised floodway or

will agree, upon default of the party responsible for such operation and maintenance, to undertake such operation and maintenance. In addition, all the information required to obtain a CLOMR must be submitted to IDNR-OWR or its designee and then FEMA (depending on the source of the map). A stormwater permit may then be issued to proceed with the revision of the floodway. Upon completion of the construction necessary to revise the floodway, as-built plans must be submitted to the Administrator and FEMA to have a LOMR issued. Once a LOMR is issued revising the floodway map, and all necessary permits have been obtained, development may proceed in the former floodway area.

## Engineering Criteria

### *Conveyance*

Regulatory floodway conveyance shall be maintained for all flood events up to and including the 100-year frequency flood except at bridges, culvert crossings, and dams. Conveyance is defined as:

$$K = \left( \frac{1.486}{n} \right) * A * (R^{2/3})$$

*Where:*

n = Manning's roughness factor

A = effective area of the cross-section

R = hydraulic radius

The same Manning's n-value shall be used for both existing and proposed conditions unless a recorded maintenance agreement with a federal, state, or local unit of government can assure the proposed conditions will be maintained or the land cover is changing from a vegetative to a non-vegetative land cover. (For a discussion of conveyance, consult *Open Channel Hydraulics* by Ven Te Chow, 1959, McGraw-Hill, New York, New York.)

### *Transition Sections*

Expansion and contraction of flow require transition sections to determine effective regulatory floodway conveyance and shall be located and determined as described in the Ordinance. Alternative transitions shall require review and approval by IDNR-OWR. Expansion is the hydraulic condition of water flowing from a narrower section to a wider section and shall be assumed to occur no faster than at a rate of one foot horizontal for every four feet of the stream length. Contraction, the condition of water flowing from a wider section to a narrower section, shall be assumed to occur no faster than at a rate of one foot horizontal for every one foot of stream length. The floodplain area outside of the expansion and contraction flow area is considered to be ineffective flow area. Effective conveyance transition sections and expansion and contraction of flow are demonstrated in many hydraulic textbooks and manuals for



hydraulic computer programs. When considering effective conveyance in a vertical direction, the expanding and contracting vertical transition shall be one foot vertical transition for every ten feet of stream length. The compensatory storage required by the ordinance may be placed within areas of ineffective conveyance within the floodway.

#### *Average Channel Velocities*

Channel velocities shall not be increased as a result of development. Minor increases may be permissible at some cross-sections along the project reach but the flow velocity of the change must remain below the scour velocity. Channel conditions vary, but channel scour must be considered if a velocity of above five feet per second is attained.

#### Flood Elevations

Flood elevations generated by the regulatory model must first be duplicated before updated data to reflect the existing conditions is input to the model. The flood profiles, flows and floodway data in the regulatory floodway study must be used for analysis of the regulatory conditions. If the study data appears to be in error or conditions have changed, IDNR-OWR or its designee shall be contacted for approval and concurrence on the appropriate existing conditions data. Once the output of the regulatory model has been duplicated to within 0.1 foot of the regulatory profile, revisions should be input to reflect the existing conditions.

If existing conditions in the watershed outside of the applicant's project site will be affected by the development, the applicant shall obtain the best available information of the proposed off-site changes to anticipate the impacts of the proposed change. The existing and with-project conditions shall be modeled based on this data.

On-stream structures built for the purpose of retaining water must be approved by the Dam Safety Section of IDNR-OWR by way of a permit or a letter stating that a permit is not required. The address for the Dam Safety Section is:

Illinois Department of Natural Resources  
Office of Water Resources  
One Natural Resources Way, 2<sup>nd</sup> Floor  
Springfield, Illinois 62702-1271

Attn: Dam Safety Section

#### Floodway Permit Applications Involving Hydraulic Analysis

There are two different conditions for development within a regulatory floodway. Either the applicant is trying to maintain the existing regulatory profile and floodway boundaries or a LOMR is requested.

The discharges from the regulatory model shall be used except where the Administrator requires new discharges. The necessity for new discharges will depend on the correlation between the existing conditions profile, the regulatory profile, and the magnitude of the impacts on the profile due to the project. If the existing conditions profile is calculated to be lower than the regulatory profile, the effects of lost storage must be analyzed, and the new hydrologic analysis must reflect the future land use. The Administrator or the applicant may contact the Director for an opinion on the suitability of the regulatory discharges. New discharges shall be developed based on stream gage analysis (if available) or shall follow the methodologies outlined in the “Hydrologic Techniques” section within the “Stormwater Runoff” portion of this manual.

The first step to determine if a revision of the regulatory floodway conditions is desired, is to duplicate the regulatory profile using the same hydraulic model (usually HEC-HMS). Data input into the duplicate model should be identical to the data, which generated the regulatory profile. It is not necessary to duplicate the entire regulatory profile but the applicant should start the profile at least four cross-section downstream of the project site. Once the input from the regulatory model has been duplicated, the output of the duplicate model should be verified against the output of the regulatory model. A copy of the regulatory profile should be submitted along with the duplicate model run as part of the permit application package.

Where there is a designated floodway mapped, but there is no computer model available, the engineer should consult the Director about how to proceed with the specifics of modeling the existing conditions.

Once the duplicated model has been prepared and is operational, it must be updated to create an existing conditions model for a comparison against the with-project conditions. As discussed in “Floodplain Performance Standards”, cross-sections should be added to the regulatory model where it is appropriate to add them for both the existing and with-project hydraulic analyses. The existing conditions model should include all corrections to the regulatory profile and should be modeled with attention to areas of ineffective conveyance. The applicant is responsible for all existing field conditions within the watershed which may affect the existing conditions hydraulic model. These areas can be maintained in the model for storage volume and area calculations by imputing an artificially high n-value for these areas (such as 99). This will cause the computer model to treat these areas as ones of ineffective flow, but the cross-sectional area is still maintained for the area and volume calculations. Ineffective flow areas should be clearly annotated on the plans and cross-sections.

The existing conditions profile must tie-in to the regulatory profile to within 0.5 foot, based on FEMA requirements, upstream and downstream of the project reach. Where it is not possible to meet the regulatory profile, a new hydrology study is required.

If the applicant is trying to maintain the existing regulatory floodway boundaries, he should scale the floodway encroachments off the regulatory floodway map and input this data into the existing conditions model. This will create the existing conditions floodway model. The with-project model must demonstrate that the proposed development has no incremental impact if the with-project condition maintains the conveyance, storage, and travel time of the existing conditions model and the flood stages are not increased.

If the applicant is trying to establish or revise a regulatory floodway, one of the standard floodway encroachment methodologies from the computer models shall be utilized. The floodway must meet the floodway definition of this Ordinance.

The floodway is considered to meet the surcharge criteria of no more than a 0.1 foot increase if the floodway meets the requirements of the Ordinance. It will be necessary for the applicant to check that the 10% velocity rule is met and these calculations should be part of the submittal to the Administrator.

The preferred approach for developing floodway encroachments involves the use of an equal amount of flood conveyance on each side of the stream centerline. Modifications to the floodway encroachment, which reduce conveyance on one side of the stream, shall first consider an increase of conveyance on the streamside directly opposite the modified encroachment. When proposed floodway modifications form the affected property owners. Floodway encroachment methodologies generally create floodways by removing conveyance from the ends of the cross-sections and will typically create floodways with a considerably narrower floodway than necessary to meet the velocity criteria. The routines are a useful tool in developing a floodway that centers its conveyance about the centerline of the stream. The applicant will have to manually adjust the encroachments to develop a floodway which meets all the criteria of the Ordinance floodway definition.

When manually adjusting the floodway encroachments at every cross-section, the applicant should start at the most downstream cross-section and work upstream. In using a backwater model floodway encroachment methodology, the upstream cross-sections should generally not have any effect on the generated encroachments from the downstream section.

The with-project conditions model will use the same regulatory discharges and cross-section locations as the regulatory conditions model to reflect the

development on the site. The applicant should first run the model using the with-project topography with the fixed encroachments set at the existing condition. If the conveyance, storage, and travel time are maintained and the flood stages are not increased, the with-project floodway will be allowed if it does not differ from the existing conditions floodway. If the rules are not yet met, there are two options: to revise the design to meet the criteria of the Ordinance or to develop a new floodway that meets the Ordinance definition and obtain a LOMR from FEMA, revising the regulatory floodway. Table 9 identifies the data requirements and reviewing agencies for the various types of revisions.

**TABLE T9-142**  
**Data Requirements for Revisions to Mapped Areas**

<b>Type of Revision</b>	<b>Data or Hydraulic Model (H.M.) Utilized</b>	<b>Reviewing/Approving Agency</b>
LOMA	Elevation	Administrator, FEMA
LOMR Based on Fill	Elevation, Certification of Fill Compaction	Administrator, FEMA
Revision to Regulatory BFEs Based on Existing Conditions	Regulatory Conditions H.M. Existing Conditions H.M.	Administrator, IDNR-OWR, FEMA
Revision to Regulatory BFEs Based on Proposed Project	Regulatory conditions H.M. Existing Conditions H.M. With-Project H.M.	Administrator, IDNR-OWR, FEMA
Revision to Regulatory Floodplain Boundaries	Elevation	Administrator, IDNR-OWR, FEMA
Revision to Regulatory Floodway Based on Existing Conditions	*Regulatory Conditions Floodway H.M. *Existing Conditions Floodway H.M.	Administrator, IDNR-OWR, FEMA
Revision to Regulatory Floodway Based on a Proposed Project	Regulatory Conditions H.M. Existing Conditions H.M. With-Project Conditions Floodway H.M.	Administrator, IDNR-OWR, FEMA

\* Where applicable, otherwise use the regulatory profile with scaled and encoded floodway encroachments.  
Note: Forward copies of all submittals to the Director.

### § T9-144 Bridge and Culvert Standards

Permits involving new stream crossings or any significant modifications to existing structures requires a hydraulic model if the stream has a regulatory floodway. Both the existing and with-project conditions should contain the same cross-section locations so that each case can be compared at all locations along the reach.

For modification or replacement of existing structures, a determination must be made whether or not the existing structure is a source of flood damage. This is done by comparing the profile of the natural channel (as if the structure did not exist) against the profile of the channel with the existing structure in place. By delineating the floodplains of each of the two profiles upstream of the restrictive structure, the applicant can determine the area that is impacted by backwater created by the restrictive structure. If a building is located in the floodplain when

analyzing a restrictive structure, but not in the floodplain when the structure is removed, the structure may be a source of flood damage. The applicant must then evaluate the feasibility of redesigning the structure to reduce the existing backwater, taking into consideration the effects on flood stages on upstream and downstream properties.

All excavations for new construction or modifications to existing structures at crossings shall be designed in accordance with Section 9-144 of the Ordinance.

Lost floodway storage must be compensated for as required in Section 9-137 B. of the “General Performance Standards” of the Ordinance. Artificially created storage lost due to a reduction in head loss behind a bridge need not be replaced, provided no damage will be incurred downstream.

Application submittal material should be submitted to IDNR-OWR for stream crossings over public bodies of water so that IDNR-OWR may issue a public notice. Also, where hydraulic analyses are required for road crossings, the application submittal material should also be submitted to IDNR-OWR for concurrence that a conditional LOMR is not required. If required, a submittal will need to be made to FEMA for the issuance of a CLOMR.

## ARTICLE VII – REQUIREMENTS FOR WETLANDS, LINEAR WATERCOURSES, NON-LINEAR WATERBODIES, BUFFERS AND MITIGATION

### § T9-168 General

A permit for any Wetland Impact, modification to a Linear Watercourse, Nonlinear Waterbody, or Buffer disturbance needs to be obtained from the Director (or Administrator in a Community certified to administer this Article). Some examples of these activities include, but are not limited to:

- Dredging a Wetland, Linear Watercourse, or Nonlinear Waterbody;
- Filling a Wetland, Linear Watercourse, or Nonlinear Waterbody;
- Relocating a Linear Watercourse;
- Stabilizing streambanks or shorelines of a Linear Watercourse or Nonlinear Waterbody;
- A Temporary Wetland Affect such as construction access through a wetland, directional bore pits or trenching utilities in a wetland, etc.; and
- Draining or flooding a wetland such that the resulting Wetland Hydrology would fall below 80 percent, or exceed 150 percent, of the existing condition storm event Runoff volume to the Wetland for the 2-year, 24-hour storm event.

### § T9-169 Requirements for Wetland Delineation

#### Delineation of On-Site Wetlands

Wetland delineations are required for all developments which have on-site Linear Watercourses, Nonlinear Waterbodies, Wetlands, and Buffers. The wetland delineation report shall identify the boundaries, location, limits and area of all on-site Linear Watercourses, Nonlinear Waterbodies, and Wetlands.

This wetland delineation will follow the current federal guidance, which is: U.S. Army U.S. Army Corps of Engineers. 2010. Regional Supplement to the U.S. Army Corps of Engineers Wetland Delineation Manual: Midwest Region (Version 2.0), ed. J.S. Wakely, R.W. Lichvar, and C.V. Noble. ERDC/EL TR-10-16. Vicksburg, MS: U.S. Army Engineer Research and Development Center. A copy of this publication may be found here:

<https://usace.contentdm.oclc.org/utis/getfile/collection/p266001coll1/id/7630>

The limits of a Linear Watercourse and Nonlinear Waterbody is the Ordinary High Water Mark. The OHWM needs to be flagged. If wetlands exist outside of the OHWM of the Linear Watercourse and Nonlinear Waterbody, flag the outermost limit of Linear Watercourse, Nonlinear Waterbody, and Wetland as one area, do not flag them as separate areas.

Farmed wetlands shall be determined by the methodology referenced in the Food Security Act program, located in the exhibit in section 514.8(A) of that document, which may be found here:

<https://directives.sc.egov.usda.gov/rollupviewer.aspx?hid=29340>

A link to the wetland identification procedures publication is here:

<https://directives.sc.egov.usda.gov/40305.wba>

The USACE also provides additional guidance on delineating farmed wetlands within the Chicago District Boundaries on their website here:

<https://www.lrc.usace.army.mil/Missions/Regulatory/Illinois/Determinations-of-Wetlands-on-Agricultural-Lands/>

Coordination of wetland delineation tasks with the NRCS is encouraged to minimize disagreements in identifying the boundary of such wetlands.

Kane County lies within the boundaries of the USACE Chicago District. Specific information on the current delineation of wetlands may be obtained from the District.

U.S. Army Corps of Engineers  
Chicago District  
Regulatory Branch  
231 South LaSalle Street, Suite 1500  
Chicago, Illinois 60604  
Phone (312) 846-5530  
Fax (312) 353-4110  
Website: <https://www.lrc.usace.army.mil/Missions/Regulatory/>  
Email: [lcregweb@usace.army.mil](mailto:lcregweb@usace.army.mil)

### Non-Jurisdictional Wetlands and Waters

The areas identified in Section 9-169.B are not considered to be Linear Watercourses, Nonlinear Waterbodies, or Wetlands. Documentation is required to verify the purpose and use of the facility and that the area was excavated or diked in an Upland area. This documentation may include, but not be limited to the following:

- Valid stormwater management permits, construction plans, as-built plans or other documentation including dedication on plats;
- A soils map depicting the area has an upland soil and historic aerials showing the area has does not have any wetland signatures prior to being excavated or diked;
- Evidence that the wetland is in fact created by drain tile breaks, irrigation, or Detention Storage Facility outlets provided to the area of hydrophytic vegetation. It is on the developer's responsibility to establish

that no other hydrology exists that would support the wetland vegetation if the artificial hydrology were removed; and

- Evidence that pits or quarries have not been abandoned for more than five years, such as: aerial documentation of quarry activities, material tickets, etc.

#### Delineation of Off-Site Wetlands:

In addition to identifying the location, extent, area and quality of on-site wetlands, off-site wetlands need to be evaluated to a distance at least 100 feet beyond the edge of the site to verify buffer requirements. This should be included in the wetland delineation report and shown on the wetland delineation exhibit.

The purpose in including off-site wetland delineation is to determine the overall value of the wetland complexes that occur on more than one property, and to determine whether or not there is a buffer required on a development site due to the existing off-site wetland.

#### Floristic Quality Index (FQI)

The use of the FQI as an indicator of wetland quality requires that a thorough evaluation of all vegetation in the potential wetland site be conducted. It is paramount that the delineator be able to identify not only the dominant plant species but also all of the hydrophytic species found within the suspected wetland area. Because the mitigation of wetlands within the county is based upon their quality, a thorough evaluation of the vegetation is necessary. This may require the evaluator to sample the wetland in more than one season, making sure to obtain both the spring and late summer flora, and will require that any delineation for permitting be conducted in the growing season. The FQI should be based solely upon the wetland vegetation; buffers and adjacent plant communities should not be included in this calculation. The purpose for including only wetland vegetation in the FQI evaluation is so that the FQI value is not falsely increased by including more conservative plants from upland prairie or other specialty habitats.

For all on-site wetlands the FQI needs to be calculated. The procedure can be found in "plants of the Chicago Region", 4<sup>th</sup> ED. by Floyd Swink and Gerald Wilhelm or by using the Chicago Region Floristic Quality Assessment (FQA) Calculator. The Chicago Region Floristic Quality Assessment (FQA) Calculator has been updated with the C values, taxa, and nomenclature found in Wilhelm & Rericha's Flora of the Chicago Region and continues to use the most up-to-date nomenclature and wetland indicator status ratings of the National Wetland Plant List (NWPL). The Chicago Region FQA Calculator also includes all upland taxa found within the Chicago Region following Robert H. Mohlenbrock's most recently published 2014 Vascular Flora of Illinois and



integrates Swink & Wilhelm's 1994 Plants of the Chicago Region nomenclature as synonyms to the NWPL allowing users to enter acronyms for either old or new plant names. This allows the user to create reports for inventory and transect assessments with the most up-to-date nomenclature and wetland indicator status ratings following the NWPL.

The Chicago Region FQA Calculator was reviewed and tested by the National Ecosystem Restoration Planning Center of Expertise and is now approved for use by the US Army Corps of Engineers. In future versions, flora of the states of Michigan, Indiana, Illinois and Wisconsin may also be added. Once a region is selected, their specific floristic information will be used to calculate metrics of the FQA. The FQA Calculator is free for download and will be updated regularly. The FQA program is available from the USACE and can be downloaded here:

<https://www.lrc.usace.army.mil/Portals/36/docs/regulatory/forms/FQA20171212.zip>

### Threatened and Endangered Species Consultation

Before a stormwater management permit is issued, the applicant needs to determine if Federal or State Threatened or Endangered species may be effected by the Development and initiate consultation with the Agencies if required. Such consultation shall reach a positive conclusion prior to the issuance of a stormwater permit.

USFWS:

Compliance with the Endangered Species Act can be achieved by obtaining a Section 7 species list for the site using the on-line application at the U.S. Fish & Wildlife Service website. The application will indicate whether resources (species and habitats) listed or designated under the Endangered Species Act of 1973, as amended (Act), may be present within areas affected (directly or indirectly) by the proposed project. You can access "U.S. Fish and Wildlife Service Endangered Species Program of the Upper Midwest" website at:

<http://www.fws.gov/midwest/Endangered>

Click on the Section 7 Technical Assistance and follow the instructions to completion. Print all documentation pertaining to the species list and include it in the wetland delineation report. If no species or habitats are listed, then a "no effect" determination can be made, and section 7 consultation is not warranted. If species or habitats appear on the list, then a biological assessment or biological evaluation will need to be completed to determine if the proposed action is likely or not likely to adversely affect them. The Corps will request initiation of section 7 consultation with the U.S. Fish and Wildlife Service upon agreement with the applicant on the effect determinations in the Biological assessment or biological evaluation. The consultation needs to reach a positive

conclusion prior to the issuance of a of a stormwater permit. The U.S. Fish and Wildlife Services may be contacted at the:

Chicago Illinois Field Office  
230 South Dearborn St., Suite 2938  
Chicago, IL 60604  
Phone: 312-485-9337  
Website: <https://www.fws.gov/midwest/Chicago/index.html>

IDNR:

The Ecological Compliance Assessment Tool (EcoCAT), was developed to help state agencies, units of local government, and Developers initiate natural resource reviews for:

- Illinois Endangered Species Protection Act [520 ILCS 10/11(b)] and Illinois Natural Areas Preservation Act [525 ILCS 30/17] as set forth in procedures under Title 17 Ill. Admin. Code Part 1075.
- Interagency Wetland Policy Act of 1989 [20 ILCS 830] as set forth in procedures under Title 17 Ill. Admin. Code Part 1090 when state agencies provide funding (including federal pass-through funding) or technical assistance.

These laws require state agencies and units of local governments to consider the potential adverse effects of proposed actions on Illinois endangered and threatened species and sites listed on the Illinois Natural Areas Inventory. EcoCAT uses databases, Geographic Information System mapping, and a set of programmed decision rules to determine if your proposed action may be in the vicinity of protected natural resources. To initiate a consultation with IDNR using EcoCAAt go to:

<http://dnr.illinois.gov/EcoPublic/>

Note that this tool only functions using Internet Explorer.

§ T9-170 Mitigation Required

#### Exceptions

All wetland impacts need to be mitigated with the exception of the following:

- A. Mitigation for dredging a wetland that has a FQI less than seven is not required if they are dredged for the purpose of creating a native vegetated Detention Storage Facility. These wetlands typically have low quality vegetation and do not currently provide significant wetland functions. Dredging is considered to be any excavation of material. Dredging need not be a total removal of the wetland. A portion of the

wetland may be excavated provided that the entire wetland has a FQI less than 7.0.

- B. A Wetland Impact to Isolated Wetlands less than 0.10 acre (4,356 square feet) in aggregate need not be mitigated, provided that one tenth of an acre (4,356 square feet) or more of the Wetlands on the Site have not been dredged or filled, cumulatively, since the Effective Date of this Chapter; and the Wetland(s) has a FQI less than twenty-five (25).

Therefore, if a developer impacts one 0.09 acre wetland on-site then mitigation for that impact is not required. However, if a site has two wetlands that are 0.09 acre each and the Developer desires to impact both, then mitigation would be required for the total impact area at the rate determined per 9-172.

Alternatively, if a developer impacts 0.08 acre of a 0.3 acre wetland on-site with 0.5 acre off-site, then mitigation for that impact is not required. However, if the developer decides to impact wetland area at a later date and the impact exceeds 0.10 acre, including the original 0.8 acre impact, then mitigation is required.

- C. A Temporary Wetland Affect does not need to be mitigated if it is restored to its pre-existing condition pursuant to Subsection 9-174.A. For instance, if a directional drill pit is proposed within a wetland with a FQA of 10, mitigation would not be required if the drill pit is filled back in with the soils at the same profile from which they were excavated and the disturbed area is planted so that the area achieves eighty-five percent coverage and a FQA of 15 within one year of the disturbance.
- D. Mitigation is not required for impacts to wetlands occurring on agricultural land that is enrolled in any program under the Food Security Act (FSA) for the previous three years and is an approved impact under the program's conservation plan. This exemption does not apply to a proposed land use change (i.e. from agricultural to other use) and areas which have been abandoned for five years or more. A USACE permit may be required per Section 9-28.C and the USACE may require mitigation under Section 404 of the Clean Water Act. It is the applicant's responsibility to document what program the Agricultural Land under the Food Security Act is enrolled in and that the impact is approved under the program's conservation plan. Applicants are encouraged to work with a qualified wetland specialist, the NRCS, and Director (or Administrator in a Community certified to administer this Article VII) to determine whether this exemption applies to the Wetlands on-site prior to application for a Stormwater Management Permit.

In order to avoid potential unauthorized impacts to wetlands or loss of USDA benefits, documentation in the form of a Subsurface Drainage Survey should be submitted to the NRCS and Director (or Administrator in a Community certified to administer this Article VII) to verify that Agricultural Subsurface Drainage System repair, replacement or improvements will not impact on-site or adjacent wetlands.

Existing Agricultural Subsurface Drainage Systems in or draining Farmed Wetlands or Wetlands on Agricultural Land that has been abandoned for five years or more, may be maintained or replaced in-kind (i.e. same location, elevation, size, length, material, or material with equivalent conveyance, etc.).

- E. Wetlands having a FQI greater than or equal to 25 are very rare and impact need to be avoided to the maximum extent practicable, unless strict application makes the site completely unbuildable. Unmitigable wetlands include those that have high plant biodiversity and cannot be replaced by creation of wetland via mitigation. Within Kane County, wetlands that score FQIs greater than 25 are those having high biodiversity or are specialized habitats such as fens and calcareous seeps.
- F. Mitigation required for indirect impacts shall be prorated by the percentage of the Tributary Area to the Wetland that is on-site (existing on-site Tributary Area/total existing Tributary Area) multiplied by the Wetland area, excluding any direct impacts via dredge or fill. Examples of which are provided in the Table on the following page:

Table T9-170

80-150 WETLAND HYDROLOGY ANALYSIS

PROJECT: Technical Manual  
 Examples  
 DATE: 2019.05.07  
 BY: ERA

User Input  
 cell w/ formula

A	B	C	D	E	F	G	H	I	J	K	L	M	N	O	P	Q	R	S	T	U	V			W
WETLAND	WETLAND TOTAL SIZE	WETLAND ON-SITE	WETLAND OFF-SITE	DIRECT WETLAND IMPACT	TOTAL REMAINING WETLAND	EXISTING ON-SITE WETLAND TRIBUTARY AREA (W/ WETLAND)	EXISTING ON-SITE WETLAND TRIBUTARY AREA	PROPOSED ON-SITE TRIBUTARY AREA (W/ WETLAND)	PROPOSED ON-SITE TRIBUTARY AREA	TOTAL EXISTING WETLAND TRIBUTARY AREA (W/ WETLAND)	% USED FOR PRORATED IMPACT	% OF WETLAND TO REMAIN	EXISTING CN	EXISTING RUNOFF	EXISTING RUNOFF VOLUME	ADJUSTED EXISTING RUNOFF VOLUME	PROPOSED CN	PROPOSED RUNOFF	PROPOSED RUNOFF VOLUME	80-150 PERCENT CHECK	HYDROLOGIC (INDIRECT) IMPACT?			TOTAL WETLAND IMPACT
	(acres)	(acres)	(acres)	(acres)	(acres)	(acres)	(acres)	(acres)	(acres)	(acres)	%	%		(inches)	(ac-ft)	(inches)		(inches)	(ac-ft)	%	U<80	U>150	Impact (Yes/No)	(E + (LxF)) OR (E)
	(C+D)	User Input	User Input	User Input	(B-E)	User Input	(G-C)	User Input	(I-C)	User Input	(H/K)	(F/B)	(from TR-55 Table 2-2)	(fx from TR-55 Figure 2-1)	(Hx(O/12))	(M x P)	(from TR-55 Table 2-2)	(fx from TR-55 Figure 2-1)	(J x (S/12))	(T/Q)				
EXAMPLE 1	0.25	0.25	0	0	0.25	3	2.75	3	2.75	3	92%	100%	79	1.44	0.33	0.33	83	1.72	0.40	120%	No	No	No	0.00
EXAMPLE 2	0.75	0.5	0.25	0	0.75	5	4.5	3	2.5	9	50%	100%	79	1.44	0.54	0.54	80	1.51	0.31	58%	Yes	No	Yes	0.38
EXAMPLE 3	9	1	8	1	8	20	19	14	13	100	19%	89%	79	1.44	2.28	2.03	83	1.72	1.87	92%	No	No	No	1.00
EXAMPLE 4	1	0.5	0.5	0	1	5	4.5	5	4.5	8	56%	100%	79	1.44	0.54	0.54	98	3.11	1.17	215%	No	Yes	Yes	0.56

## § T9-171 Mitigation to Be Local

The County recognizes that wetlands are a valuable resource to Kane County and each major watershed. Allowing mitigation outside Kane County represents a loss of the benefits that wetlands provide. However, currently there are no wetland mitigation banks within the County in the Kishwaukee River watershed. Allowing mitigation for impacts within the Kishwaukee River watershed outside of the County allows communities inside that watershed to continue to realize the benefits the wetland provided while allowing the Director the ability to approve banking outside the County without a variance. To avoid double mitigation requirements, mitigation for wetland disturbances required under a USACE section 404 permit may be allowed outside the County within a USACE approved bank with available credits in the event that a USACE approved bank with available credits isn't available within the County at the time of approval.

## § T9-172 Mitigation Requirements

### Linear Watercourse

If Linear Watercourses are to be completely or partially relocated, Mitigation may be made through stream restoration. See T9-173 for further details.

### Wetland Mitigation

When wetland mitigation is required, the following approaches may be used to meet the mitigation requirement.

1. Mitigation may occur in a facility designed for wetland mitigation and constructed by the applicant.
2. Mitigation may be satisfied by purchase of credits from a wetland mitigation bank. This bank needs to be an approved mitigation bank by the USACE or the Director and needs to be a mitigation bank occurring within the boundaries of Kane County unless mitigation for the wetland impact is required under a USACE section 404 permit and is required within a USACE approved bank, and credits in a USACE are not available within the County at the time of approval.
3. Mitigation requirements may also be satisfied by paying a fee in lieu of mitigation as described in 9-179.

When mitigation is required, the ratio of mitigation necessary to meet the ordinance is clarified in the Table below.

**TABLE T9-172  
Mitigation Requirements**

<b>FQI</b>	<b>Activity</b>	<b>Mitigation Ratio</b>	<b>Mitigation Options</b>	<b>Comments</b>
Any	Temporary Wetland Affect	N/A	Mitigation not required if restored in-kind within 1 year.	
<7	Dredging for Detention Storage Facility	N/A	Mitigation not required	
<7	Dredging	1:1	Detention Storage Facility, Wetland Mitigation Facility, approved Wetland Bank, or Fee in lieu of Mitigation	0.25:1 wetland credit per acre for enhancement of wetlands w/ FQI less than 7
<7	Fill	1:1	Detention Storage Facility, Wetland Mitigation Facility, approved Wetland Bank, or Fee in lieu of Mitigation	0.25:1 wetland credit per acre for enhancement of wetlands w/ FQI less than 7
7-16	All	2:1	Wetland Mitigation Facility Approved Wetland Bank, or Fee in lieu of Mitigation	
16-25	All	3:1	Wetland Mitigation Facility, approved Wetland Bank, or Fee in lieu of Mitigation	
>25	All	10:1 + 0.5 for each point that the FQI exceeds 25	Not mitigable* Wetland Mitigation Facility, approved Wetland Bank, or Fee in lieu of Mitigation	See example below.
Any with T&E Species	All	3:1	Wetland Mitigation Facility, approved Wetland Bank, or Fee in lieu of Mitigation	

\* See Ordinance Section 9-170.E.

An example mitigation calculation for Wetland Impacts to a Wetland with a FQI greater than twenty-five is as follows:

One tenth of an acre (0.1 acre) of impact is proposed to a four (4) acre wetland with a FQI of 32 in order to obtain economic use of the Site. Mitigation for that impact is required at a ratio of ten to one (10:1) plus one-half (1/2) for each point by which the FQI exceeds twenty-five (25) rounded up to the nearest whole number for Wetland Impacts upon Wetlands with a FQI of more than twenty-five (25).

$$10 + \left(\frac{FQI - 25}{2}\right) = \text{Mitigation Ratio (rounded up)}$$
$$10 + \left(\frac{32 - 25}{2}\right) = 13.5 (\text{round up}) = 14$$

Therefore, the impact is required to be mitigated at a ratio of fourteen to one (14:1). The Developer is be required to provide 1.4 acres of Wetland Mitigation for this impact.

The ratios increase with increasing floristic quality as a “safety factor” because the loss of biodiversity is difficult to replace. It should be noted that if mitigation is required for multiple wetlands on a site, the standards of the highest quality wetland impacted shall be applied. Again, the purpose of this requirement is to ensure that higher quality wetlands receive greater protection or are replaced at higher mitigation ratios. Applicants are encouraged to avoid and minimize impacts to wetlands. The enhanced mitigation ratios are set up to reflect the difficulty in replacing diverse wetlands and the applicant should carefully consider avoiding and minimizing impacts to these resources.

## § T9-173 Wetland Mitigation Plan

### Wetland Mitigation Plan

If mitigation is required and is proposed within a Wetland Mitigation Facility, a mitigation plan needs to be submitted as part of the Stormwater Management Permit application.

A minimum of two wetland plant communities is necessary for an area to qualify as a Wetland Mitigation Facility. These plant communities need to be appropriate for the site on which they are contained and be a naturally occurring wetland type within Kane County. These include, but are not limited to: wet prairie, emergent marsh, hemimarsh, floating vascular, shrub-scrub, wooded, forested floodplain, sedge, meadow, wet meadow, fen or calcareous seep, submerged aquatic, and mudflat annual. It should be noted that certain plant communities including, fens, submerged aquatic environments, hemimarsh,



and mudflat annuals will be more difficult to establish or measure their performance. Thus, to attain the goal FQI, performance standards may be more difficult to meet than for other plant communities.

Open water should not constitute greater than 20% of the entire Wetland Mitigation Facility. As noted previously, detention storage can only be used for wetlands being mitigated with an FQI less than seven and Open water should not constitute greater than 20% of the Detention Storage Facility if used for these purposes.

Buffers are required around the edges of Wetland Mitigation Facilities and these will be in accordance with the Section 9-177 of Article VII for the drainage area or categories of FQI values and size of the wetland. No buffer is required between a wetland mitigation facility and an adjacent wetland that is preserved on site. If protective measures are installed along the perimeter of a Wetland Mitigation Facility's Buffer, the width may be reduced by up to ten percent (10%) immediately adjacent to the protective measure. The reduction in width that may be applied due to installation of protective measures but may not be applied where Buffer width averaging has been used and the Buffer would be more than fifty percent (50%) less than originally specified. Protective measures may consist of fencing, native vegetated Detention Storage Facilities, BMPs or other methods approved by the Director (or Administrator in a Community certified to administer this Article VII). Additionally, Buffer width averaging may be allowed by the Director (or Administrator in a Community certified to administer this Article), if the width is not be more than fifty percent (50%) less, at the narrowest point, than the required width; and is not less than fifteen feet (15'). High potential Buffer function areas may also be re-established to meet Buffer averaging requirements for Developments that are required to provide a Detention Storage Facility, upon approval by the Director (or Administrator in a Community certified to administer this Article).

For instance, a developer proposes to impact a 0.5 acre wetland with a FQI of 7. The Site requires a Detention Storage Facility. A 0.75 acre Wetland Mitigation Facility with a FQI of 10 is required. The resulting required buffer width is 20 feet. The Detention Storage Facility would be allowed to occupy the outer 2 feet of the of the buffer. The Developer may also have the option to construct the Detention Storage Facility in the outer 5 feet of the buffer and increase the buffer width to 25 feet on the opposite side of the Wetland Mitigation Facility where an existing turf grass area can't be utilized.

### Stream Restoration Plan

If Linear Watercourses are modified, a stream restoration plan needs to be submitted as part of the Stormwater Management Permit application.

If a Linear Watercourse is completely or partially relocated, the newly created portion needs to be of equal or greater length than the existing Linear

Watercourse and be constructed in a manner which will allow naturalizing to occur. This discourages relocating and channelizing streams as part of a Development.

Buffers are required around the edges of Wetland Mitigation Facilities and these will be in accordance with the Section 9-177 of Article VII for the drainage area or categories of FQI values and size of the wetlands associated with the Linear Watercourse. If protective measures are installed along the perimeter of a Stream Restoration's Buffer, the width may be reduced by up to ten percent (10%) immediately adjacent to the protective measure. The reduction in width that may be applied due to installation of protective measures but may not be applied where Buffer width averaging has been used and the Buffer would be more than fifty percent (50%) less than originally specified. Protective measures may consist of fencing, native vegetated Detention Storage Facilities, BMPs or other methods approved by the Director (or Administrator in a Community certified to administer this Article VII). Additionally, Buffer width averaging may be allowed by the Director (or Administrator in a Community certified to administer this Article), if the width is not be more than fifty percent (50%) less, at the narrowest point, and the required width and is not less than fifteen feet (15'). High potential Buffer function areas may also be re-established to meet Buffer averaging requirements for Developments that are required to provide a Detention Storage Facility.

For example, 100 linear feet of a stream with 20 acres of tributary area bisects a single family residential Site. In order to build a house on the Site without the stream running under it, the stream needs to be re-meandered around the proposed house. The proposed stream length is 120 linear feet and a 35 foot buffer is required. The Owner proposes to provide a fence between the lawn and buffer and preserve an additional 15 feet of wooded area on the opposite side of the Stream resulting in a 16.5 foot buffer between the re-meandered stream and lawn. The Director rejects the application as the buffer width is less than 50% of the of the required width (17.5 feet). The applicant needs to decrease the lawn width by 1.5 feet and provide a 52.5' wide buffer on the opposite side of the stream.

## § T9-174 Mitigation Performance Standards

### Wetland Mitigation Facilities

The following mitigation performance standards are the minimum requirements for the establishment and maintenance of Wetland Mitigation Facilities under Article VII.

The proposed wetland acreage in the Wetland Mitigation Facility needs to meet the definition of a wetland as defined in this Ordinance. A wetland delineation of the wetlands in the Wetland Mitigation Facility may be required to document

that the proposed acreage is present. Buffers do not count as Wetland Mitigation.

A minimum 85% vegetative cover is necessary prior to acceptance of the wetland mitigation facility as complete. This percentage of coverage is required to prevent erosion and plant herbivory. Several Plant Communities, such as Emergent, floating vascular and Open Water are allowed a lesser coverage requirement as these areas typically do not exhibit 85% coverage in a natural setting. These areas should be designed so as not to expand into other plant communities designed within the wetland mitigation facility. The use of submerged aquatics within the open water area is recommended, particularly for small shallow bodies of water. Open water areas should be designed to minimize the development of algae blooms, to the extent practicable. Open water areas should also be designed to minimize the use of these areas by locally resident nuisance goose populations. A Wetland Mitigation Facility, including the Buffer, may not be dominated or contain cumulatively more than ten percent (10%) cover by non-native or invasive species. The USDA list of noxious, invasive, and introduced plants (required to be eradicated from developed properties) may be found here:

<https://plants.usda.gov/java/noxious?rptType=State&statefips=17>

The IDNR Partner List of Exotic Weeds may be found here:

<https://www.invasive.org/species/list.cfm?id=151>

In addition to these standards, the floristic quality improvements are required as part of the mitigation performance standards and they are detailed in the Table T9-174.A.

TABLE T9-174.A  
Floristic Quality Mitigation Performance

Impacted Wetland FQI	Required FQI
<7	Original FQI + 3
7-25	Original FQI + 5
>25	Not mitigable*

\* See Ordinance Section 9-170.E.

### Stream Restorations

The following mitigation performance standards are the minimum requirements for the establishment and maintenance of stream restoration areas under Article VII.

In a stable stream the amounts of water and sediment that come into the channel on a regular basis are roughly equal to the amounts of both that leave it. Therefore, all constructed in stream structures shall be dynamically stable. This means that degradation, aggradation, width adjustment, or planform changes beyond typical transport of the sediment entering the stream.

Essentially the in stream structures should not be accumulating sediment, down cutting or widening.

No rills or gullies shall be present on stabilized streambanks. Rills and gullies on streambanks are a sign of erosion occurring from concentrated overland flow entering the stream.

A minimum 85% vegetative cover is necessary on the overbank and buffer areas prior to acceptance of the stream restoration as complete. This percentage of coverage is required to prevent erosion. Vegetated areas in the stream and along the toe are allowed a lesser coverage requirement as these areas typically do not exhibit 85% coverage in a natural setting. A stream restoration, including the Buffer, may not be dominated or contain cumulatively more than ten percent (10%) cover by non-native or invasive species. Information regarding non-native or invasive species may be found at the links below:

The USDA list of noxious, invasive, and introduced plants (required to be eradicated from developed properties) may be found here:

<https://plants.usda.gov/java/noxious?rptType=State&statefips=17>

The IDNR Partner List of Exotic Weeds may be found here:

<https://www.invasive.org/species/list.cfm?id=151>

In addition to these standards, the floristic quality improvements are required as part of the mitigation performance standards and they are detailed in the Table below.

TABLE T9-174.B  
Floristic Quality Mitigation Performance

<b>Stream or Stream with Associated Wetland FQI</b>	<b>Required FQI</b>
Stream only, no existing Wetlands	10
Stream with Wetlands with FQI <7	Original FQI + 3
Stream with Wetlands with FQI 7<25	Original FQI + 5
Stream with Wetlands with FQI >25	Not mitigable*

\*See Ordinance Section 9-170.E.

### Buffer (Re)Establishment Areas

See T9-177 for guidance for Buffer (re)establishment areas that are not part of a Wetland Mitigation Facility or stream restoration.

### § T9-175 Mitigation Monitoring

The maintenance and monitoring provisions of wetland mitigation facilities and stream restorations are included in 9-175 and 9-176. A thorough maintenance and monitoring plan includes an annual work schedule describing each task in

detail and its expected effect, the time of year it will be performed, and any measure of success of the technique as employed. Changes to the mitigation and monitoring plan may be approved by the Director as necessary.

### Monitoring Period

All wetland mitigation facilities developed under this ordinance are monitored and managed for five years beginning on the day the wetland planting is complete. All vegetated areas of stream restorations are monitored and managed for three (3) years beginning on the day planting is completed.

### Procedures

The procedures for monitoring wetland mitigation facilities are set by the current Chicago District Corp of Engineers Protocols. These sampling methods should include a vegetation map based upon as-built drawings of the completed grading. This information needs to be descriptive and define the limits of each vegetative community type installed. Permanent transects for sampling vegetation need to be shown on this map. The dominant species and the planting lists should also be submitted with the monitoring plan. Additionally, representative photographs of each vegetative area should be submitted with the annual monitoring report. These photographs should be based upon each transect location and have an overall view of the transect area. An inventory of the vascular plant community needs to be taken according to the procedures identified by Masters (1996) in *Monitoring Vegetation in the Tall Grass Restoration Handbook for Prairies, Savannas and Woodlands* edited by Packard and Corat, Island Press, 1996. The mean C value, FQI, and wetness coefficient needs to be calculated for each quadrat to document compliance with the performance criteria.

An overall mean C value as well as the FQI for each vegetative community needs to be established using the procedures identified in the FQI program. A relative frequency and relative coverage for each species should be identified for each plant community. On an aerial base each plant community should be delineated. The soil in each wetland community will need to be evaluated for morphologic, physical and chemical characteristics to determine whether hydric soil conditions exist. This includes redoxomorphic features and manganese accumulations, oxidized rizospheres, depleted matrices and other mottle colors. Any special mitigation features developed, as part of the wetland mitigation facility should be described, and their function evaluated annually during the monitoring period. The annual report for the monitoring program covers the calendar year from January 1<sup>st</sup> to December 31<sup>st</sup> and needs to be submitted to the Director no later than February 15<sup>th</sup> of the following year.

## § T9-177 Buffer Requirements

## Definition

Buffers are defined in the Kane County Stormwater Ordinance as predominantly vegetated Upland areas within a defined width adjacent to Wetlands and Waters of the U.S. that provide a function that eliminate or minimize adverse impacts to those areas.

Buffer functions include:

- Reducing flood flow rates,
- Velocities and volumes;
- Promoting bank stability;
- Filtration of sediment,
- Nutrients and other pollutants;
- Insulation and moderation of daily water temperatures; and
- Habitat for aquatic and terrestrial fauna and flora.

Areas that do not provide Buffer functions include:

- Impervious non-vegetated surfaces,
- Permanent structures or buildings,
- Land in agricultural production within the past five (5) years, and
- Maintained turf or landscape areas as of the effective date of this ordinance or previously permitted.

Therefore, if an area within the width defined by the Ordinance does not provide a buffer function it is not a Buffer.

## Applicability

Projects that were previously permitted under previous version of the Ordinance that established areas in conservation or drainage easements for the purpose of protecting, enhancing or reestablishing a Buffer. The Buffer within these areas need to be preserved as previously permitted or protected, and if disturbed, shall be re-established.

Buffers are applicable to all development projects, however Buffer (re)establishment may not be required for all projects. Therefore, these requirements have been separated into the two categories: 1. Developments that do not require a Detention Storage Facility; and 2. Developments that require a detention storage facility.

1. For projects that do not require a Stormwater Detention Facility the applicant should follow the steps below in their stormwater permit application to document how this section is applicable to their development:
  - a. Determine the limits of the wetland per 9-169;

- b. Determine the width of the buffer based upon the requirements in 9-177.B;
- c. Show the limits of wetland and buffer on the plan to determine if the development or disturbance is proposed within the buffer;
- d. If the development is within the buffer document areas that are and are not providing buffer functions (i.e. turf grass areas vs. wooded areas);
- e. An applicant may develop an area that is not providing buffer functions without any further requirements;
- f. If the development is within an area providing buffer functions the applicant should try to relocate the development outside of the buffer or minimize the footprint of the development within the buffer.
- g. If the applicant cannot relocate the Development outside of the Buffer the applicant should calculate the area of impact within the portion of the buffer that is providing a Buffer function;
- h. The Developer may provide buffer averaging to offset the impacts to the buffer. Additionally, accessory Structures (i.e., toolshed) and impervious surfaces may occupy a maximum of fifteen percent (15%) of the portion of the required Buffer that extends onto or is part of a Site.

An example Development within a Buffer with these requirements is on the following page.

### Example T9-177.A

#### Existing Conditions:

- Residential Property
- A Wetland is off-site within 100' of the property
- The Wetland has a 100' Buffer as the Stream is Biologically Significant and the FQI is >16
- The property was platted before 2001 and the yard was maintained turf as of the Effective Date of the ordinance

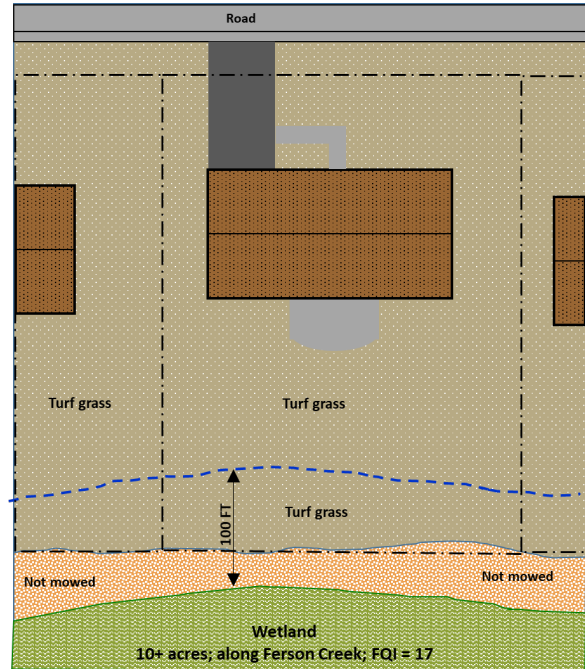

#### Proposed Conditions:

- Owner wants to install a 1,600 sq. ft. pool & patio

#### Wetland Permitting Requirements:

- No wetland impacts (no excavation/fill is proposed in the wetland and Property Tributary area is less than 10% of the tributary area to the wetland)
- No Buffer requirements (no wetland impacts and a Detention Storage Facility is not required)

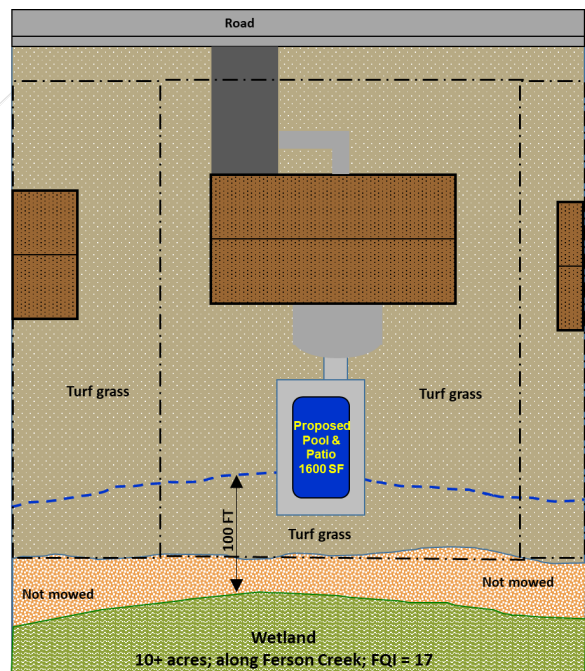



2. For projects that require a Stormwater Detention Facility the applicant should following the steps below in their stormwater permit application to document how this section is applicable to their development:
  - a. Determine the limits of the wetland per 9-169;
  - b. Determine the width of the buffer based upon the requirements in 9-177.B;
  - c. Show the limits of wetland and buffer on the plan to determine if the development or disturbance is proposed within the buffer;
  - d. If the development is within the buffer document areas that:
    - (1) Are providing buffer functions;
    - (2) Are not providing buffer functions (i.e. paved areas);  
and
    - (3) Areas that have high potential to provide Buffer functions (i.e. agricultural land in production).
  - e. If the development is within the Buffer the applicant should try to relocate the Development outside of the buffer;
  - f. If the applicant cannot relocate the Development outside of the Buffer the Applicant should:
    - (1) Calculate the area of impact within the portion of the buffer that is providing a Buffer function;
    - (2) Provide buffer averaging to offset the impacts to the buffer;  
and
    - (3) Re-establish areas that have high potential to provide Buffer Functions. Re-established Buffer areas may be used to meet Buffer averaging requirements at the discretion of the Director or Administrator.

An example Development within a Buffer with these requirements is on the following page.

### Example T9-177.B

#### Existing Conditions:

- Agricultural Property
- A Linear Watercourse runs through the property with a drainage area > 640 acres
- Wetlands are present along the toe of the bank
- Row crops are planted up to the edge of the channel
- Vegetation in the 50 foot Buffer (stream with drainage area > 640 ac) is not providing Buffer function, however this area has high potential to provide Buffer functions

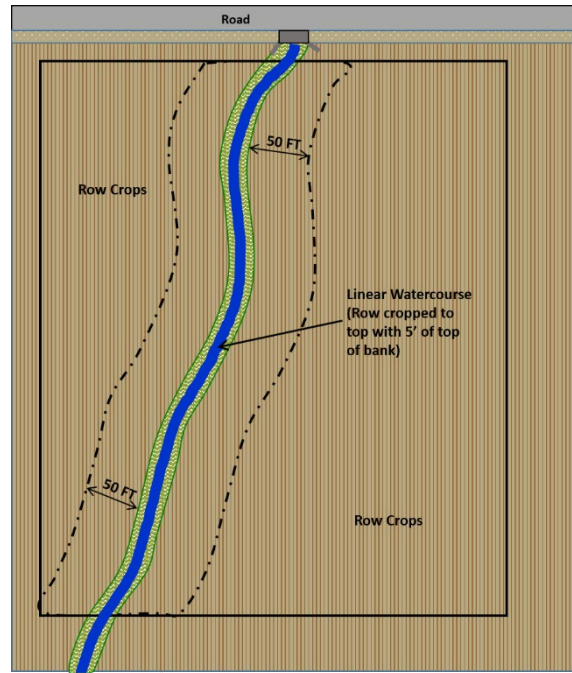

#### Proposed Conditions:

- Proposal to develop property into a residential subdivision
- >25,000 of new Impervious is proposed and Stormwater Management Measures are Required

#### Wetland Permitting Requirements:

- No wetland impacts are proposed (no excavation/fill is proposed in the wetland and Property Tributary area is less than 10% of the tributary area to the wetland)
- Buffer (re)establishment is required 50' from the edge of the wetland
- The Detention Storage Facilities may be located within the outer 50% of the buffer at the discretion of the Director or Administrator.

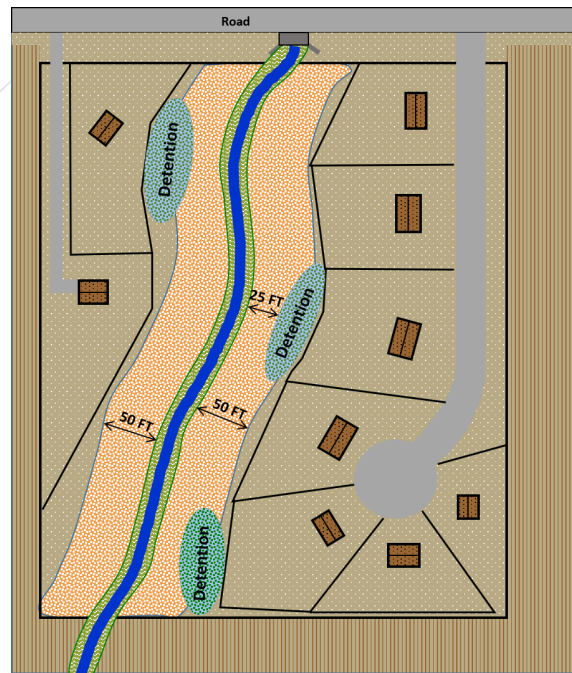

## Exemptions

Buffers are not required for Redevelopment projects on Sites adjacent to the main Channel of the Fox River. No buffers are required for wetlands less than 0.1 acre in size. These wetlands are under the mitigation threshold therefore buffering them would be place additional requirements on areas that may likely be impacted during development. Buffers are not required for Major and Minor Stormwater Systems and Stormwater Mitigation Measures provided they are not a Waters of the U.S. or Wetland.

## Buffer Width Requirements

A Buffer shall not constitute a Linear Watercourse, Nonlinear Waterbody or Wetland. These areas may not be encroached upon to create buffer.

Buffer widths required as part of a USACE Section 404 permit supercede the widths described in the Ordinance unless the width under the Ordinance is greater.

A Site may contain Buffer that originates from a Linear Watercourse, Nonlinear Waterbody or Wetland located on another property. An example of this is below:

Figure T9-177.A

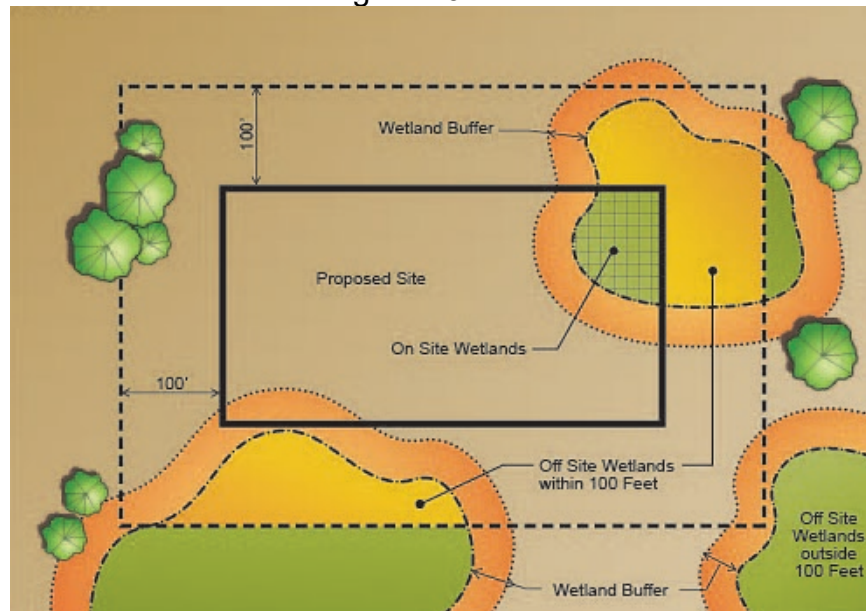

One special, but common occurrence is when a 404 permitted fill occurs. The Buffer width required by the Ordinance immediately adjacent to the area of impact does not apply. "Immediately adjacent" refers to the area within fifteen

feet (15') of the area of impact, which may be used to transition from no Buffer to the required width. However, it should be noted that buffer may be required by the 404 permit. An example of this is illustrated below:

Figure T9-177.B

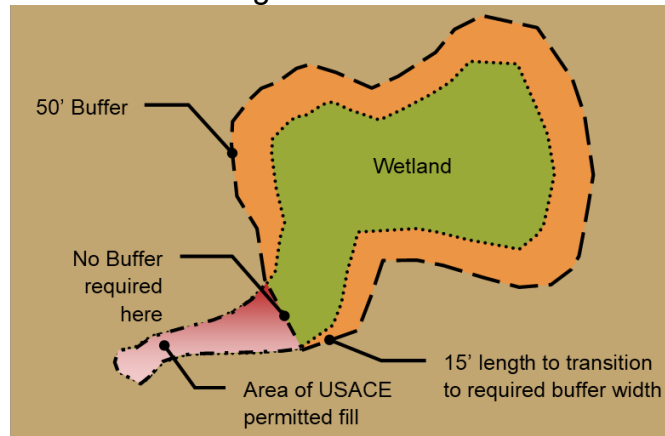

Two types of buffers are recognized: linear buffers and water body buffers (Figure T9-177A). For the purpose of measuring the width of the buffer, the interior edge of the buffer begins at the delineated boundary for wetlands and at the Ordinary High Water Mark for Linear Watercourse and Non-Linear Waterbodies. Typically, this will be the edge of bank for ponds and lakes and the top of bank for linear watercourses.

Buffer widths are a minimum of 50 feet wide unless they are determined otherwise using 9-177.B.5.a or 9-177.B.5.b.

### *Linear Buffers*

Linear buffers are designated along Linear Watercourses including associated wetlands. Examples of these include:

- Intermittent water courses
- Creeks
- Streams
- Rivers

Floodplain wetlands associated with streams are covered by 9-177.B.5.b and include:

- Floodplain wetland
- Backwater slough
- Oxbow
- Bordering wetland complex

Linear buffer widths are 50 feet, if the drainage area is greater than 640 acre or the FQI is >16.0. For drainage areas less than 640 acre and a FQI  $\leq$  16.0, the buffer width may be reduced by using the formula below:

$$X = (A \times 0.0547) + 30$$

Where:  $X$  = buffer area  
 $A$  = drainage area

The buffer width calculated will be rounded up to the nearest five feet. Alternatively, the buffer width may be estimated from Figure 9-177.1 in the Ordinance.

Linear buffer widths are 100' when the Linear Watercourse is rated A or B for diversity or integrity or is mapped as Biologically Significant by the current edition of "Integrating Multiple Taxa in a Biological Stream Rating System" by the Illinois Department of Natural Resources. Streams Rated A or B for diversity or integrity or mapped as Biologically Significant are currently: Tyler Creek, Ferson Creek, Little Rock Creek, Big Rock Creek, Welch Creek, Mill Creek, and Blackberry Creek.

See the Figures below for examples.

Figure T9-177.C Linear Watercourse Buffers with <640 acres Tributary Area

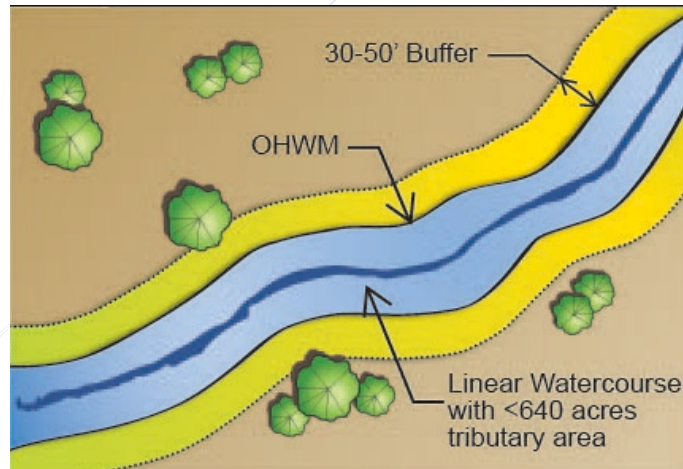

Figure T9-177.D Linear Watercourse Buffers with >640 acres Tributary Area or FQI>16

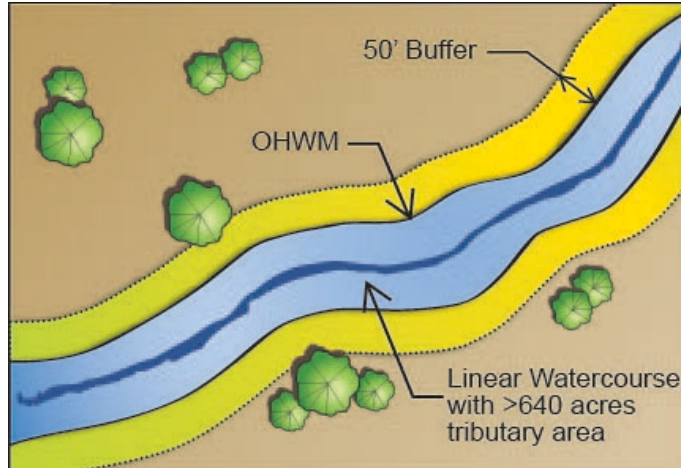
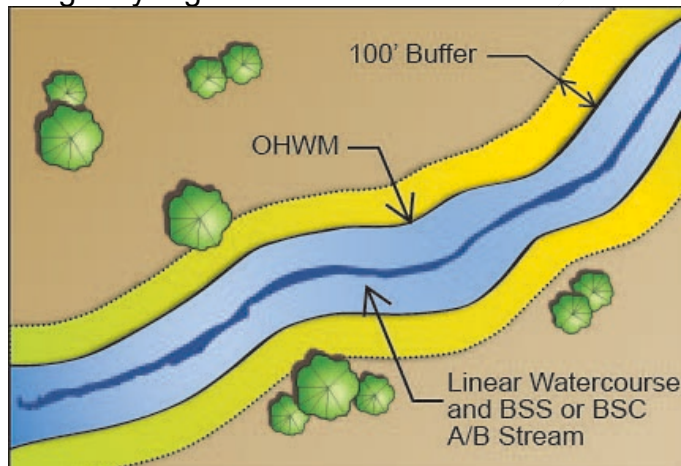

Figure T9-177.E Linear Watercourse Buffers with Stream that is Biologically Significant or Rated A or B for diversity



### *Water Body Buffers*

Water body buffers encompass all non-linear water bodies including, but not limited to lakes, ponds that are Waters of the U.S. and Wetlands that are not located along a Linear Watercourse. The buffer width should be determined using the FQI and the Tables in the Ordinance. An accurate FQI is necessary to determine the appropriate buffer width. If the FQI is performed before May 1st or after October 15th it will be considered preliminary and the maximum buffer width for that size wetland will be assumed. See the Figure below for examples.



Figure T9-177.F Water Body Buffers

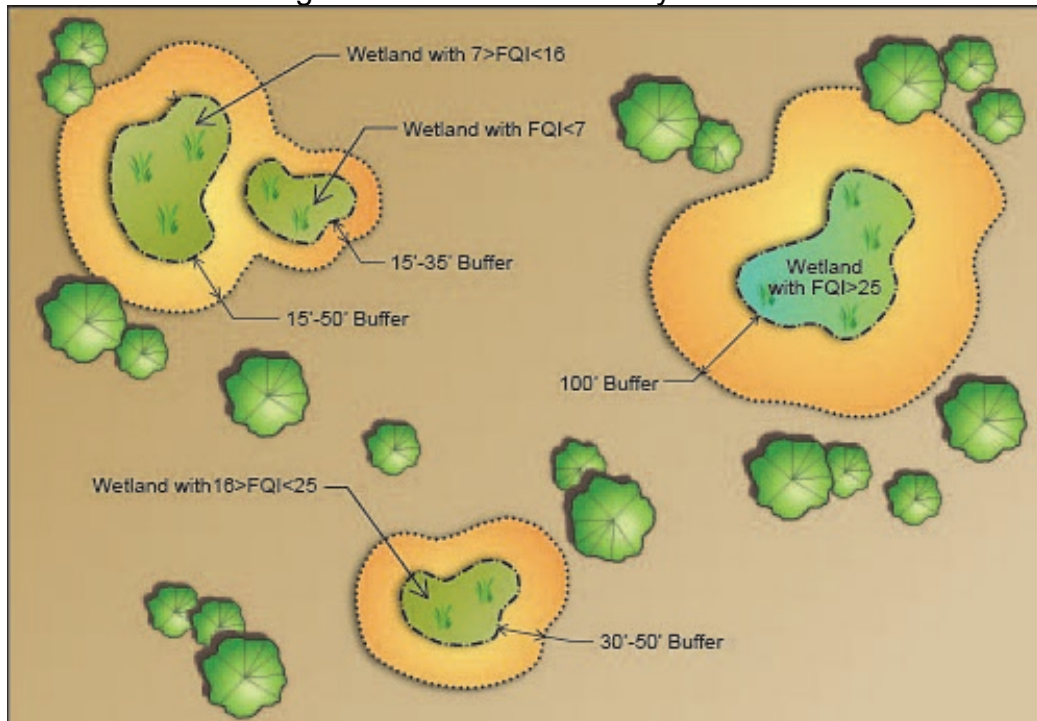

### *Protective Measures*

If protective measures are installed along the perimeter of a Buffer, the width may be reduced by up to ten percent (10%) immediately adjacent to the protective measure. Protective measures may consist of fencing, native vegetated Detention Storage Facilities and BMPs. Other protective measures may be proposed to the Director or Administrator, approval of those measures is at their discretion.

### Buffer Averaging

In both linear and water body buffers, buffer width averaging may be utilized. If Buffer width averaging is proposed the width may not be more than fifty percent (50%) less, at the narrowest point, than the required width. Additionally, if using protective measures and Buffer width averaging, the Buffer may not be more than fifty percent (50%) less than originally specified. Buffer width average should not result in a Buffer width less than fifteen feet (15'). If a site requires a Detention Storage Facility High potential Buffer function areas may be re-established to meet Buffer averaging requirements. Approval of averaging using re-establishment is at the discretion of the Director or Administrator. An example of scenario is depicted in the Figure below.

Figure T9-177.G Buffer Averaging

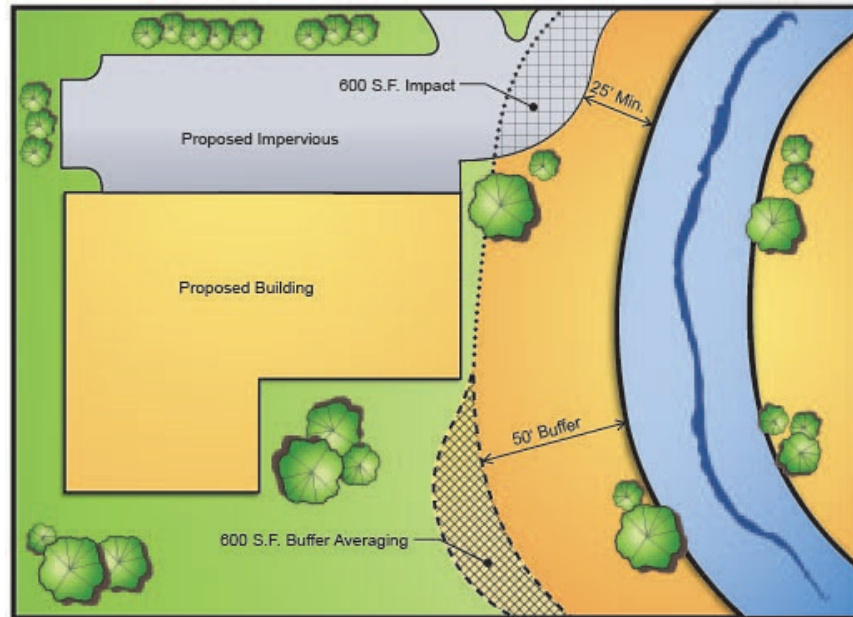

#### Buffer (Re)Establishment:

Native vegetation, particularly deep-rooted warm season grasses and prairie forbs, are required for (re)establishing buffers via seeding, re-seeding, or inter-planting buffers. Only plant species Native to Kane County should be used. "Wild Plants of Kane County" by Richard Young identifies species that are native and non-native to Kane County. The latest edition of the book is available from the Kane County Forest Preserve District and some local book stores. Plants should be obtained from nurseries that acquire seed locally (less than 200 mile radius is recommended). Genetically modified native species are not allowed as some cultivars spread aggressively.

#### *Performance Criteria and Monitoring:*

Buffer (re)establishment has been separated into the two categories: 1. Buffer (re)establishment areas less than five thousand (5,000) square feet, cumulatively on-site; and 2. Buffer (re)establishment areas greater than five thousand square feet (5000 sq. ft.), cumulatively on the Site. Both scenarios require a minimum coverage of 85% to eliminate the potential for erosion. Buffer (re)establishment for small projects requires a one-year monitoring period and no more than 25% dominance by non-native Invasive species. Larger developments with greater areas of (re)establishment require a three-year monitoring period, a FQI greater than 10, and no more than 10% dominance by non-native Invasive species.

The USDA list of noxious, invasive, and introduced plants (required to be eradicated from developed properties) may be found here:



<https://plants.usda.gov/java/noxious?rptType=State&statefips=17>  
The IDNR Partner List of Exotic Weeds may be found here:  
<https://www.invasive.org/species/list.cfm?id=151>

### Disturbance During Construction

Construction disturbance of buffers is allowed provided it was permitted. Therefore, if construction access, grading, etc. is proposed in the buffer it should be illustrated on the plans. If an unpermitted disturbance occurs to a buffer it needs to be (re)established per the Ordinance.

### Access

Access by equipment into buffer areas is allowed to the extent necessary to provide maintenance to the buffer and/or maintenance and monitoring activities associated with wetlands within buffers.

Buffer areas that are on private property will typically continue to not be accessible to the general public.

### Free from Development Once Established:

Once established, buffers should be maintained free from Development.

### *Exceptions*

A few exceptions are included in the Ordinance. An example relating to 9-177.H.1.a, accessory Structures (i.e., toolshed) and impervious surfaces may occupy a maximum of fifteen percent (15%) of the portion of the required Buffer that extends onto or is part of a Site, is on the following page:

## Example T9-177.A

### Existing Conditions:

- Residential Property
- A Wetland is off-site within 100' of the property
- The Wetland has a 100' Buffer as the Stream is Biologically Significant and the FQI is >16
- The Buffer is vegetated with native plantings. The square footage of buffer on the property is 4,000 sq. ft.

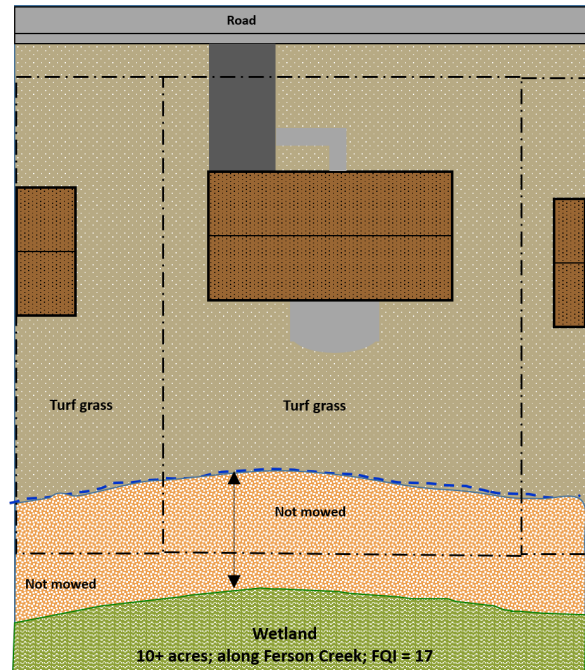

### Proposed Conditions:

- Owner wants to install a 1,600 sq. ft. pool & patio.
- 550 sq. ft. of the pool will encroach into the Buffer.

### Wetland Permitting Requirements:

- No wetland impacts (no excavation/fill is proposed in the wetland and Property Tributary area is less than 10% of the tributary area to the wetland)
- Buffer impact is less than 15% of the Buffer area on the Site.
- No Buffer re-establishment is required.

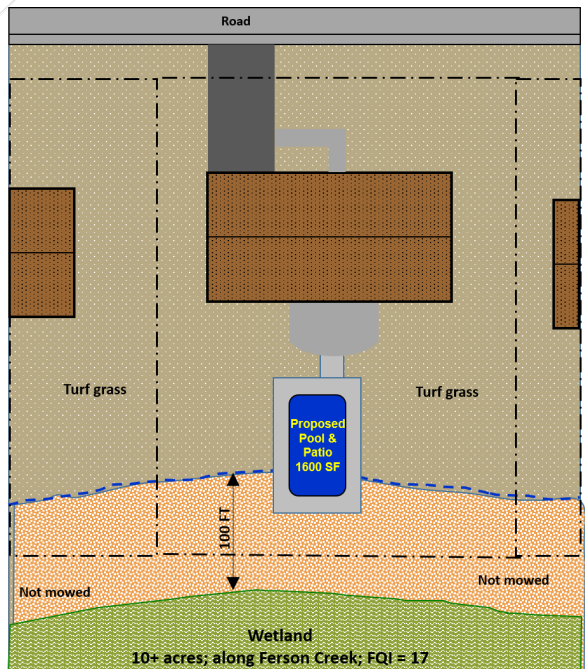

### *Easements and Declarations of Restriction and Covenant*

Easements are required over Linear Watercourses, Nonlinear Waterbodies, Wetlands and their associated Buffers. Additionally, the Stormwater Management Permit number, and any associated maintenance requirements shall be noted on the plat or included as a covenant running with the land in any deed which conveys any portion of a Buffer area.

If a Detention Storage Facility is not required, and the project does not include a Wetland Mitigation Facility, an easement over Linear Watercourses, Nonlinear Waterbodies, Wetlands and Buffers on-site is not required. However, a Declaration of Restriction and Covenant that acknowledges the presence of these features, the Stormwater Management Permit number, and any associated maintenance requirements should be recorded. Note that, an easement may be required at the discretion of the Administrator. An example of a Declaration of Restriction and Covenant is provided in Appendix A.

#### § T9-179 Fee-in-Lieu of Wetland Mitigation

If a wetland mitigation is required under this ordinance, the applicant may choose to satisfy the mitigation requirement by paying a fee-in-lieu of mitigation. To satisfy the requirements the applicant will provide a cost estimate to mitigate the wetlands in a Wetland Mitigation Facility and Wetland Mitigation Bank (if Credits are available), as if they had chosen to satisfy the mitigation requirement either manner. Each estimate requires the approval of the Director (or Administrator in a Community certified to administer this Article) and the fee-in-lieu of wetland mitigation will be the greater of the two estimates.

#### § T9-180 Wetland Submittal

Per Section 9-168 a permit is required for any Wetland Impact, modification to a Linear Watercourse, Nonlinear Waterbody, or Buffer disturbance shall be obtained from the Director (or Administrator in a Community certified to administer this Article). A thorough list of the wetland submittal requirements is in the Ordinance. Examples of several Submittal requirements are provided below for clarification.

#### Wetland Delineation Report

A thorough wetland delineation report typically includes:

- All field data and inventories shall be provided on current USACE data forms or approved equivalent;
- Floristic Quality Assessment for each wetland;
- Narrative description of the Linear Watercourses, Non-linear Waterbodies and wetlands and their associated buffers;
- Project Location map;

- Kane County ADID Wetland Map;
- Kane County Soil Map;
- FIRM;
- Wetland Delineation Map on an aerial photograph of the Site showing: approximate locations of data sampling points, wetlands boundaries with the name/number labeled (i.e. Wetland 1, Waters of the U.S. A, etc.), acreage of each wetland, and approximate location and quality of off-site wetlands within 100' of the property;
- Other mapping products may include: historic aerial photos, previous permitted plans; and as-built drawings to document if an area was excavated out of upland;
- Consultation with the Illinois Department of Natural Resources to determine if the Site is inhabited by a state listed threatened or endangered species and obtain a consultation termination letter or other instrument of approval;
- An evaluation of the Site in accordance with current USFWS review procedure for threatened and endangered species; and
- Site photos as necessary to describe wetland and other regulated areas including representative, current growing season photographs of each wetland plant community.

### Wetland Impacts and Mitigation Narrative

This is a narrative description of the proposed plan that includes the description of the wetlands (i.e. total acreage, impact acreage, FQI, buffer width, etc.) to be impacted and the means of mitigation (on or off-site Wetland Mitigation Facility, Wetland Mitigation Bank, or Fee-in-lieu of Wetland Mitigation).

### Indirect Impact Analysis

A table is provided above to assist with these calculations. A link to the Excel file for this Table may be found **HERE**. In order to fill in the table the following information for the Site is needed.

- An exhibit illustrating the following: all wetlands on-site and within 100 ft of the site, each wetlands acreage both on and off-site, all wetlands to be directly impacted and the acreage of that impact for each Wetland; the existing and proposed on-site tributary Drainage Area to each Wetland; and the off-site Tributary Areas to each wetland;
- Existing and proposed condition land use documentation and soil type; Existing condition and proposed Runoff volume calculations using the 2-year, 24-hour storm event. A link to TR-55 is located here:  
[https://www.nrcs.usda.gov/Internet/FSE\\_DOCUMENTS/stelprdb1044171.pdf](https://www.nrcs.usda.gov/Internet/FSE_DOCUMENTS/stelprdb1044171.pdf)

Where practical, the stormwater management system should be designed to maintain or replicates the existing hydrologic condition of the Wetland.

Essentially the hydrology shouldn't be routed away from the wetland to a detention basin if it is feasible for the detention basin to be located so that it outlets to the wend. unless changes are proposed to enhance the Wetland function

#### Wetland Mitigation Facility Plan Narrative

This is a narrative description of the hydrology to be created, the soils that will be utilized and local geomorphologic conditions that impact the construction of the wetland. This should include a description of both surface and groundwater conditions, relating to the construction and maintenance of the Wetland Mitigation Facility. Specifications for construction, monitoring and maintenance should include specifications for rough and final grading, type and depth of soils to be used, plant materials to be used and how and where they will be procured and from. Specifications should also include water control structures, specifications related to the planting plan including scientific and common names, rates of seeding or spacing, as appropriate, and any special planting provisions necessary for a successful wetland mitigation.

#### Stream Restoration Plan Narrative & Calculations

This is a narrative description of the stream to be restored including: the existing and proposed length, width, slope, sinuosity of the stream; local geomorphologic conditions that impact the construction or stabilization of the stream; expected velocities in the stream; etc. Specifications for construction, monitoring and maintenance should also be included with the stream restoration plan. These include: rough and final grading of the stream; in-stream features such as pools, riffles, rock vanes, toe wood, stream bed material, etc.; and specifications for their construction including: type, size, and methods for installation of bed and bank stabilization materials to be used. Vegetation to be planted on the overbank areas, along the toe or in the stream bed. This should include: scientific and common names, rates of seeding or spacing, as appropriate; how they will be procured; and from what sources.

#### Wetland Mitigation Facility Plan Drawing:

Each wetland mitigation plan needs to have a drawing that depicts the limits of the wetland mitigation facility as well as wetlands that are impacted on the on-site wetlands. The summary table on this drawing should include the acreage to be disturbed, the acreage to be mitigated, the mitigation ratio and the total mitigation acreage.

ARTICLE VIII – PERFORMANCE SECURITY



ARTICLE IX – LONG-TERM MAINTENANCE

§ T9-233 Incorporation of Long-Term Maintenance of Stormwater Facilities

Stormwater infrastructure requires long-term maintenance like any other utility (e.g. street lighting, road resurfacing, etc.). It is expected that Stormwater Management Measures, Major and Minor Stormwater Systems, off-site Outfalls and Special Management Areas be maintained in their permitted condition in perpetuity. In order to document what the ongoing maintenance of these features includes the Applicant needs to develop a long-term management plan and this plan needs to be included in the plat of easement or recorded as a Declaration of Restriction and Covenants. This informs the Homeowners Association and property Owners of their maintenance obligations.

The long-term management plan needs to identify the Person or responsible party for maintaining these features. This can be the job title of the person responsible, as this may change as individuals over time. The long-term management plan needs to also list of the features to be maintained and their associated maintenance tasks.

The long-term maintenance Plan needs to include:

1. Maintenance tasks for these areas and all supporting infrastructure (e.g. restrictor, emergency overflow, etc.) to be inspected and maintained. An example inspection form for these areas has been provided in Part 2. Example Long-Term Performance Criteria for Further details for each aspect of the areas to be inspected and maintained is below.
2. A schedule for inspection and maintenance of these areas. An example schedule has been provided below:

Table T9-233.A  
Example Annual Inspection & Maintenance Schedule:

SCHEDULE	TASK DESCRIPTION
Early Spring	Prescribed burn of native vegetated areas (if fall burn is not scheduled or previous fall burn was not achieved)
Late Spring/Early Summer	Site inspection of all Stormwater Management Measures, Major and Minor Stormwater Systems, off-site Outfalls and Special Management Areas
	Herbicide application or mowing to target early emerging invasive species within native vegetated areas
	Removal of debris
	Repair of infrastructure
Summer	Stabilization of an eroded areas
	Herbicide application to target warm season invasive species

	Proprietary feature maintenance
	Removal of accumulated silt
Fall	Follow up inspection of deficient or repaired areas
	Prescribed burn (if no spring burn was conducted)

An annual report documenting the completion of inspection and management tasks based on the above should be submitted to the Administrator at the frequency required by the Administrator. Note that an annual report is not required for Category I BMPs, however these areas must still be inspected and maintained in accordance with their long term Maintenance Plan. Reporting is necessary for the Community to meet the terms and conditions of the Certified Community. If any area is deficient, the responsible entity should provide a detailed explanation and propose corrective measures. It is the applicant’s responsibility to rectify any deficiencies. If necessary, the Administrator may levy the SSA to fund and perform the corrective measures.

Long-Term Performance Criteria

Native vegetated areas that are required by the Stormwater Management Permit need to meet a set of minimum performance standards that were developed in order for the Certified Community to conclude if the plantings were “successful” enough to warrant a finding of compliance and release of the security. The long term success of these areas beyond the short term maintenance and monitoring period is important for preserving their functional and aesthetic value. If they are allowed to degrade the public will associate these areas with neglected waste spaces. Achieving the desired effect is dependent upon periodic management with a minimum criterion for which these areas should not fall below. The following is an example management plan that includes a schedule describing minimum management requirements for continued success of the native vegetated areas contained within a project site.

*Example Long-Term Naturalized Area Management Plan Language:*

Yearly maintenance tasks are the key to ensuring continued success of native vegetated areas. These tasks should be preceded by a site inspection to determine if remedial measures are required and to recommend procedures to correct any deficiencies. The site inspection should be conducted by an individual knowledgeable in native plants and management of native plantings or restorations. Areas of observation during the site inspection should include, but are not limited to: dominant species within distinct planting communities (wetlands, buffers, basin bottoms, side slopes, upland areas, etc.); erosion or herbivory concerns that develop over time; changes in hydrology that may require additional planting to adjust for higher or lower water levels; or the appearance of invasive species in the managed area that require management. Vegetation sampling procures are as follows:

- A. Sampling must occur during the growing season.



- B. Sampling may consist of a time meander search to record species presence.
- C. A visual estimate of species dominance should be made.
- D. A Floristic Quality Assessment should be performed.
- E. Representative photographs should be taken at the time of sampling.
- F. A standardized form should also be used that covers all of the aspects of the planting area that may require attention. An example form is provided in Part 2. An annual native vegetated area inspection form should contain the following information:
  - Cover, determined by visual estimate, to ensure no bare earth is exposed leaving the area open to erosion. If the coverage is deficient then corrective measures should be taken in these areas.
  - Dominant species within each plant community (i.e. detention basin bottom, side slopes, buffer, etc.) shall be identified. If one of the three most dominant plant species in any of the native vegetated areas is non-native or invasive species, then corrective measures should be taken in these areas.
  - Plant Community Quality – Calculate the native mean C values, FQI and native mean wetness coefficient for all of the areas. If the native mean C value or the FQI decreases, then corrective measures should be taken in these areas.
  - Representative photographs of each vegetation area by general community zone shall be submitted to the entity responsible for maintenance and the certified community.

Performance criteria for which native vegetated areas may not fall below is as follows:

- A. No individual area over the entire native vegetated area greater than 0.25 square meter shall be devoid of vegetation, as measured by aerial coverage.
- B. None of the three most dominant plant species in any of the native vegetated areas may be non-native or invasive species, unless otherwise indicated on the approved long-term maintenance plan.
- C. The FQI of the Native Vegetated Area shall not fall below 3 points lower than permitted FQI in the performance criteria.

The following management activities should be completed annually unless otherwise specified in the management plan:

1. Debris Removal: All debris shall be removed, via non-invasive methods, from within the special management area. Debris may consist of organic material like trees that have fallen into a stream and is creating a snag, or inorganic material like a shopping cart or grocery bags.
2. Herbicide Application: Selective herbicide to control invasive species should be completed twice yearly. A certified and licensed pesticide applicator shall select herbicide, appropriate for the area of use (such as wetlands or other special management area), and shall apply the herbicide by the appropriate method, to prevent killing of desirable native species. Invasive and non-native species, and woody plant species not specified as part of the planting plan, shall be controlled by appropriate management practices of the approved plan.
3. Prescribed Burning: If possible, a prescribed burn is suggested every other late fall/early spring. Controlled burns are essential for even germination, establishment of deep root systems, and maintenance of non-native invasive species. Water should be sprayed around young woody plantings prior to controlled burns to ensure they are not damaged by fire before they grow large enough to establish. These burns should only be performed by a qualified burn contractor.
4. Mowing: Mowing to a height of no less than 8" with a specialty flail-type mower or weed whipper may be substituted for prescribed burns in instances where a burn is not permissible, or weather does not allow for a safe burn.
5. Erosion Control & Stabilization: When conducting the annual monitoring report, it is important to observe and note areas of bare soil and other early warning signs of erosion. If caught early, they may be easily stabilized with seed and erosion control blanket. If the signs of erosion are not observed early enough, the situation may require deep rills or gullies to be filled in and stabilized with rock or other means.
6. Brush Clearing: Management of woody species is not likely necessary if prescribed burns and herbicide applications are successful. If invasive shrubs become a problem they should be cut and all remaining stumps should be treated with an appropriate herbicide to prevent resprout, either through a basal oil treatment, hand wick applicator, or other approved method. In the instances where brush removal using machinery is required due to accumulation of woody plants too large to cut by hand and treat with herbicide, it should be conducted in the winter

while the ground is frozen to avoid soil disturbance caused by heavy machinery and by crews hauling cut branches and trunks out of the management area.

Table T9-233.B  
Example Annual Maintenance Schedule:

SCHEDULE	TASK DESCRIPTION
Early Spring	Prescribed burn (if fall burn is not scheduled or previous fall burn was not achieved)
Late Spring/Early Summer	Site inspection Herbicide application or mowing to target early emerging invasive species
Summer	Herbicide application to target warm season invasive species
Fall	Prescribed burn (if no spring burn was conducted)

## ARTICLE XI – ENFORCEMENT AND PENALTIES

### § T9-286 Required Inspections

The Administrator needs to inspect or have inspected projects which are permitted under this Ordinance from time to time. Inspection should be performed during construction to insure compliance with the permitted plans, but should also be performed occasionally after the permitted project is completed so that such things as required maintenance can be monitored and so that no changes to facilities are made without a permit. The Administrator has the authority to develop his own inspection program. As an aid to Administrators, the Long Term Stormwater Facility Maintenance - Certified Community Inspection Form in Part 2 of this Manual may be used in their inspection program.

**PART 2 – FORMS AND REFERENCE DOCUMENTS**



## FORMS AND REFERENCE DOCUMENTS

The following sheets contain forms and reference documents that are meant to be copied and used by either the developer/applicant, community official or review engineer. The forms and documents contained in this section are listed below.

1. Kane County Stormwater Management Permit Worksheet
2. Kane County Wetland Submittal Worksheet
3. Erosion and Sediment Control Inspection Report
4. Kane County Stormwater Maintenance Guidelines for HOAs
5. Long Term Stormwater Facility Maintenance - Certified Community Inspection Form
6. Kane County Requirements for Steep Slope Zones
7. Substantial Improvement, Substantial Damage and Maintenance Form
8. Developers Right to Draw on Security Form
9. Declaration of Restriction and Covenant for Linear Watercourse, Non-Linear Waterbody, Wetland and Wetland Buffer Areas
10. Declaration of Restriction and Covenant for Category I Stormwater Mitigation/Best Management Practices (BMPs)



# KANE COUNTY STORMWATER MANAGEMENT PERMIT WORKSHEET

Please refer to Kane County and Certified Community Stormwater Management Ordinances for definitions of technical terms in bold and referenced Ordinance sections for additional information.

## Step 1:

### Is a Stormwater Management Permit Required (Section 9-28 A):

- A. Does the project disturb more than 5,000 sq ft of ground or involve 250 CY of material or more?
- B. Is the project in a **Floodplain** or is there **Floodplain** on the **Site** (including renovations or repairs to existing structures in the **Floodplain**)?
- C. Does the project impact a **Wetland**?
- D. Does the site have an existing **Detention Storage Facility** and new **Impervious Area** is being added that is not accounted for in the **Detention Storage Facility**?

**If you answered YES to any of the above questions, PROCEED TO STEP 2**

If you answered NO to all of the above questions, a **Stormwater Management Permit** is NOT required, however, **Erosion and Sedimentation Control Practices** (Article III) are required for all projects regardless of whether a permit is required or not.

## Step 2:

### Calculate Stormwater Management Measure Triggers (Table 9-81):

- A. **Hydrologically Disturbed Area** (proposed as part of this application) \_\_\_\_\_ acre(s)
- B. **New Impervious Area** since Jan 1, 2002 (existing) \_\_\_\_\_ sq ft
- C. **New Impervious Area** (proposed as part of this application) \_\_\_\_\_ sq ft
- D. CALCULATE total **New Impervious Area** (SUM B+C=D) \_\_\_\_\_ sq ft

### Redevelopment Only:

- E. Existing **Impervious Area** to be removed (as part of this application) \_\_\_\_\_ sq ft
- F. CALCULATE **Net New Impervious Area** (SUBTRACT D-E = F) \_\_\_\_\_ sq ft

**PROCEED TO STEP 3**

## Step 3:

### Stormwater Mitigation/BMP Submittal (Article V):

- A. Is there an existing flooding or drainage issue in the immediate vicinity of the project?
- B. Is the **New** or **Net New Impervious Area** (proposed as part of this application - Step 2 C or Step 2 F) greater than 5,000 sq ft?
- C. Linear projects: is the **New** or **Net New Impervious Area** (proposed as part of this application- Step 2 C or Step 2 F) > 43,560 sq ft?
- D. Is the **Hydrologically Disturbed Area** greater than 3 acres?
- E. Is the Total **Impervious Area** on the **Site** greater than 50% (for a **Site** <1 acre)

**If you answered YES to any of the above questions, a Stormwater Mitigation/BMP may be required**

**PROCEED TO STEP 4**

Stormwater  
Mitigation/BMP  
Submittal

Yes

No

## Step 4:

### Stormwater Submittal (Article IV):

- A. Is the **New** or **Net New Impervious** (Step 2 D or Step 2 F) greater than 25,000 sq ft?
- B. Linear projects: is the **New** or **Net New Impervious** (Step 2 D or Step 2 F) > 43,560 sq ft and width >AASHTO?
- D. Is the **Hydrologically Disturbed Area** greater than 3 acres?

If you answered YES to any of the above questions, a **Stormwater Submittal and Detention Storage Facility** may be required

**PROCEED TO STEP 5**

Stormwater Submittal
<input type="checkbox"/> Yes
<input type="checkbox"/> No

## Step 5:

### Wetland and Floodplain Submittal (Article VII and Article VI):

- A. Does the **Site** contain or is adjacent to a **Linear Watercourse, Nonlinear Waterbody** or **Wetlands**?
- B. Does the **Site** contain **Floodplain**?

If a **Qualified Review Specialist** has answered YES to either question above, a **Wetland and/or Floodplain Submittal** may be required

**PROCEED TO STEP 6**

Wetland Submittal
<input type="checkbox"/> Yes
<input type="checkbox"/> No

Floodplain Submittal
<input type="checkbox"/> Yes
<input type="checkbox"/> No

## Step 6:

### What's Next?:

- A. Use the Kane County Stormwater Ordinance for additional information on required submittals. Contact the **Permitting Authority** to address questions or confirm submittal requirements
- B. Complete the **Stormwater Management Permit** application for the **Certified Community**
- C. Complete the submittals required for the project including the Plan Set Submittal (Article II), Soil Erosion and Sedimentation Control, Performance Security (Article VIII) and Maintenance Schedule (Article IX) in addition to submittals required above.

### Disclaimer:

This worksheet provides general guidelines for determining potential requirements for a project. The worksheet includes requirements for conventional projects, however it does not address special conditions or exemptions contained within the Ordinance language or address complex project such as redevelopment with an existing detention facility. It is recommended that Applicants communicate with the **Permitting Authority** to confirm permit requirements. The **Permit Authority**, upon review of the project, may require additional submittals or **Stormwater Management Measures**.





## KANE COUNTY WETLAND SUBMITTAL WORKSHEET

Please refer to Kane County and Certified Community Stormwater Management Ordinances for definitions of technical terms in bold and referenced Ordinance sections for additional information.

### Step 1:

#### **Wetland Delineation (Section 9-169):**

A. Are there **Wetlands** identified on the **Site**?

**If YES - PROCEED TO STEP 2**

B. Are there **Wetlands** identified within 100' of the **Site** but no **Wetlands** on the **Site**?

**If YES - PROCEED TO STEP 3**

If you answered NO to both questions above, a **Wetland Submittal** is NOT required.

### Step 2:

#### **USACE Wetland Jurisdiction Determination (Section 9-180):**

A. Obtain one of the following forms of documentation from **USACE**: A Jurisdictional Determination or a Letter of No Objection (where no impacts to Waters of the US are proposed)

**If Wetlands are USACE Jurisdictional and direct impacts are proposed, submit a Joint Permit Application to USACE and obtain permit. If Wetlands are not USACE Jurisdictional or indirect impacts are proposed PROCEED TO STEP 3**

If a Letter of No Objection is received and NO indirect impacts are proposed PROCEED TO STEP 4

### Step 3:

#### **County/Community Jurisdictional Wetlands:**

A. Are there Direct (**County/Community** Jurisdiction) or Indirect (either **County/Community** or **USACE** Jurisdiction) Impacts to a **Wetland** proposed by the **Development**?

**If YES, prepare a Wetland Mitigation Plan in accordance with Article VII then PROCEED TO STEP 4**

If NO **Wetland Impacts** are proposed, PROCEED TO STEP 4

### Step 4:

#### **Buffer Requirements (Section 9-177):**

A. Determine **Buffer** widths for all on-site **Wetlands** and **Wetlands** within 100' of the site per Section 9-177 and document any existing conservation easements established previously for protecting a **Buffer**.

B. Document all areas within the delineated **Buffer** width that meet the definition of a **Buffer** per the **Ordinance**.

C. Verify that no **Buffer** violations exist within existing conservation easements on the site.

D. Determine if the Development impacts an area within the delineated **Buffer** width that meets the definition of a **Buffer** or within an existing conservation easement?

**If YES - Verify the requirements in Section 9-177.B are met for Buffer Impacts and prepare a Buffer Impact Plan**

E. Determine if a **Detention Storage Facility** (Table 9-107) is required for the **Development**?

**If YES - Buffer (Re)establishment is required in accordance with Section 9-177.C. Prepare a Buffer (Re)Establishment Plan then PROCEED TO STEP 5**

If NO Buffer (Re)establishment is required, PROCEED TO STEP 5

---

## Step 5:

### Review Wetland Submittal Requirements (Section 9-180) - Check if Required:

- Wetland Delineation Report and USFWS
- Jurisdictional Determination, Letter of No Objection or USACE Permit
- Wetland Mitigation Plan
- Buffer Impact Plan
- Buffer Re(Establishment) Plan

## Step 6:

### What's Next?:

- A. Use the Kane County Stormwater Ordinance for additional information on required submittals. Contact the **County/Community** to address questions or confirm submittal requirements
- B. Complete the **Permit** application

### Worksheet Terms and Definitions (refer to the Ordinance for full, official definitions):

**Buffer:** Predominantly vegetated **Upland** areas within a defined width adjacent to **Wetlands** or **Waters of the US** that provide a function that eliminate or minimizes adverse impacts to those areas. Areas that do not provide **Buffer** functions include: impervious non-vegetated surfaces, permanent **Structures** or **Buildings**, land in agricultural production within the past five years and maintained turf or landscape areas

**County/Community:** For brevity, in this worksheet only, this term shall mean "Director (or Administrator in a Community certified to administer Article VII of the Ordinance)"

**Wetland:** For brevity, in this worksheet only, the term "Wetland" may encompass Wetlands, Linear Watercourses and Non Linear Waterbodies.

**Wetland Impact:** Conversion of a Wetland to a non-Wetland via a direct impact caused by the dredging or filling of any Wetland; or Indirect Wetland Impact caused by a Development activity that would result in the Wetland Hydrology falling below 80 percent or exceeding 150 percent of the existing condition storm event Runoff volume to a Wetland for the 2-year, 24-hour storm event

### Disclaimer:

This worksheet provides general guidelines for determining potential **Wetland Submittal** requirements for a project. It is recommended that **Applicants** communicate with the **County/Community** to confirm permit requirements.

## EROSION AND SEDIMENT CONTROL INSPECTION REPORT

Project Name: \_\_\_\_\_ File No.: \_\_\_\_\_  
Inspection Date: \_\_\_\_\_ Time: \_\_\_\_\_ Inspected By: \_\_\_\_\_

### Stage of Construction

Pre-Construction Mtg.     Rough Grading     Finish Grading  
 Clearing & Grubbing     Building Construction     Final Stabilization

### YES NO N/A    Inspection Checklist

- |             |   |
|-------------|---|
| ___ ___ ___ | 1. Have all disturbed areas requiring temporary or permanent stabilization been stabilized? Seeded? Mulched? Graveled?  |
| ___ ___ ___ | 2. Are soil stockpiles adequately stabilized with seeding and/or sediment trapping measures?  |
| ___ ___ ___ | 3. Does permanent vegetation provide adequate stabilization?  |
| ___ ___ ___ | 4. Have sediment trapping facilities been constructed as a first step in disturbance activity?  |
| ___ ___ ___ | 5. For perimeter sediment trapping measures, are earthen structures stabilized?   |
| ___ ___ ___ | 6. Are sediment basins installed where needed?  |
| ___ ___ ___ | 7. Are finished cut and fill slopes adequately stabilized?  |
| ___ ___ ___ | 8. Are on-site channels and outlets adequately stabilized?  |
| ___ ___ ___ | 9. Do all operational storm sewer inlets have adequate inlet protection?  |
| ___ ___ ___ | 10. Are stormwater conveyance channels adequately stabilized with channel lining and/or outlet protection?  |
| ___ ___ ___ | 11. Is in-stream construction conducted using measures to minimize channel damage?  |
| ___ ___ ___ | 12. Are temporary stream crossings of non-erodible material installed where applicable?   |
| ___ ___ ___ | 13. Is necessary restabilization of in-stream construction complete?  |
| ___ ___ ___ | 14. Are utility trenches stabilized properly?   |
| ___ ___ ___ | 15. Are soil and mud kept off public roadways at intersections with site access roads?  |
| ___ ___ ___ | 16. Have all temporary control structures that are no longer needed been removed? Have all control structure repairs and sediment removal been performed?               |
| ___ ___ ___ | 17. Are properties and waterways downstream from development adequately protected from soil erosion and sediment deposition due to increases in peak stormwater runoff? |



# Kane County Stormwater Maintenance Guidelines for HOA's

## Table of Contents – Drainage Infrastructure Maintenance Plan

- A. Emergency Procedure and Contact List
  - Emergency Procedure
  - Call List & protocol
  
- B. Subdivision Information
  - Subdivision Plat & Easements
  - Engineering Plans (Record Drawings)
  - Covenants and By Laws
  - HOA Official Contact List
  
- C. Drainage Mapping & Inventory Documentation
  - Drawing format (size, CAD platform, etc)
  - Line styles symbols and call out standards
  - Infrastructure attributes
  
- D. Inspections & Record Keeping
  - Routine Inspections
  - Post Rainfall Inspection
  - Incident Inspection
  - Annual reporting format
  - Inspector qualifications
  - Inspection checklists
  
- E. Annual Maintenance Guidelines & Schedule
  1. Flushing, cleaning and sediment removal
  2. Vegetation management
  3. Stormwater Management Basin
  4. Televising, lamping
  5. Operations budget
  
- F. Appendix
  - Applicability
  - Definitions
  
- G. Capital Budget Development (Future)

## **A. Emergency Procedure and Contact List**

- **Emergency Procedure**

An emergency condition is considered any condition where there is a threat to public or individual health, safety or welfare. This guide pertains to drainage infrastructure and therefore is directed towards drainage emergencies. ALL emergencies where there is an IMMEDIATE THREAT to individual health, safety or welfare should be initiated with a call to 911.

Immediately subsequent to observing or becoming aware of an emergency the following procedure is suggested as a guideline.

1. Imminent Threat - CALL 911
2. Contact HOA President / Vice-president  
*If president is notified allow President / Vice-president to continue contact procedure.*
3. Contact HOA Engineer
4. Contact Emergency Response Contractor

- **Call List**

**HOA President**

Name :  
Address :  
Business :  
Home :  
Cell :  
Work :

**HOA Vice - President**

Name :  
Address :  
Business :  
Home :  
Cell :  
Work :

**HOA Engineer**

Name :  
Address :  
Business :  
Home :  
Cell :  
Work :

**HOA Emergency Response Contractor 1**

Business :  
Name :  
Address :  
Work :  
Cell :  
24 Hour Phone :

**HOA Emergency Response Contractor 2**

Business :  
Name :  
Address :  
Work :  
Cell :  
24 Hour Phone :

## **B. Subdivision Information**

- **Subdivision Plat & Easements**  
The recorded subdivision plat shall be obtained from the County (Recorders Office) and a paper copy placed in this binder. The plat sets forth property boundaries and the legal rights of access for maintenance and replacement of the drainage infrastructure. Additional easements recorded before or after the original subdivision plat should be placed here as well. The easements shall have the documents number and recording date and time stamp legible.
- **Engineering Plans (Record Drawings)**  
Original construction documents (engineering plans where available) shall be obtained and a paper copy placed in the binder. It is preferred to have record information but any form of final engineering is valuable in determining the design intent of the drainage improvements contemplated for the subdivision.
- **Covenants and By Laws**  
Recorded covenants and bylaws should be printed and placed in the binder. As the covenants or bylaws are changed, the current active version should be kept.
- **HOA Official Contact List**  
A list of current board members noting position, address, phone and e-mail contact information shall be provided. This list shall be kept current upon replacement of board members or changes in responsibilities. (See Emergency Contact Information)

### **C. Drainage Mapping & Inventory Documentation**

Mapping the subdivision drainage infrastructure is essential to create an inventory, facilitate emergency response and manage the operation of the drainage infrastructure.

This mapping would be provided in two formats.

**Master Plan** - The first is a 24 inch by 36 inch master drawing of the entire subdivision. This could be provided in a larger format (36 inch by 42 inch or 36 inch by 48 inch) if warranted. The master plan includes an aerial photo from the County, parcel information, two foot contours, floodplain and ADID wetland areas. The title block shall follow the format established herein. All elements of the drainage infrastructure (noted below) shall be depicted.

**Field Plan** - The second format is 8 ½ by 11 (or 11 by 17) detail sheets for ease of field use. The scale and level of detail may be the same or may vary from the master drawing pending the size of the subdivision and the complexity of the drainage infrastructure.

- **Drawing size**  
Preferred drawing size is 24 inch by 36 inch for the master drawing and 8 ½ by 11 for the field sheets.
- **Data Formats** - In addition to the hard copy format a digital data file of the drainage infrastructure mapping shall be provided in PDF format; stored on a thumb drive and kept with this binder.
- **Line styles symbols and call out standards**  
The following elements shall be identified on the infrastructure maps. Some elements noted below may not be shown on existing engineering plans and shall be field verified and depicted on the infrastructure map.
  - Storm Sewer gravity
  - Storm Sewer force main
  - Manhole
  - Catch basin
  - Inlet
  - Subdivision Outfall
  - Flared End Sections
  - Perforated drainage pipe
  - Pre-development or off-site drainage tile
  - Drainage swales
  - Detention basins
  - Emergency Overflow Routes
  - Floodplain
  - Floodway
  - Base Flood Elevation
  - Wetlands
  - Fencing
  - Walls
  - Restrictor Structures



- Infrastructure attributes  
The following attributes are desired to be collected for drainage infrastructure elements. It is recognized that elevation information requires a field survey to obtain.

#### Simple field verification

- Drainage Structure size, material and Type
- Grate type (open / closed)
- Pipe, size, material, type
- Fencing, walls, guard rails, type and general height
- Emergency overflow routes width and direction of flow
- Flow Restrictor details, size & type

#### Survey field verification

- Structure rim elevations
- Pipe invert and direction (i.e. N, S, NW, etc.)
- Flow Restrictor elevation
- Emergency overflow route elevation

#### Engineering Plan verification

- Detention basin numbered (HWL, NWL, Type)
- Outfall locations numbered
- Ditch / swale drainage routes
- Special Management Area labeled
- Flow Restrictor details, size, type, elevation

- Certification – Drainage Infrastructure mapping shall be reviewed and certified by a Registered Professional Engineer.

## **D. Inspection Record Keeping**

Inspections shall be performed on a routine basis as well in response to resident concerns or incidents. These inspections shall follow a standard format to provide uniformity in nomenclature and to facilitate response and management. Community staff may be available to assist during inspections and can provide continuing technical assistance along with the HOA engineer.

### **1. Routine Inspections**

- Routine Inspection format and reporting - The inspection checklist shall be utilized for routine inspection of drainage infrastructure. In addition to the checklist, the inspection / report log shall be completed and the inspection checklist sent (fax / e-mail) to the Community staff.
- Routine Inspection intervals – It is recommended that inspections every 6 months be performed on the drainage infrastructure. It is recommended that the first inspection occur in March prior to the spring rains to verify inlets, pipes and drainage-ways are open and functional. This also provides an entire construction season to investigate, evaluate and construct improvements should major concerns be observed. The second inspection would occur in September before seasonal rains to verify the functionality of the drainage system. This allows time for an emergency repair prior to winter.
- Routine Inspection Procedure – The inspection shall begin with a review of infrastructure elements and common defects noted in the checklist. Also, the Master Map shall be reviewed to identify all outfalls and drainage systems / basins. The inspection shall commence from each outfall and the system walked to the end of each branch until all elements have been evaluated. Field Maps can be utilized to assist in identifying the location of defects. An action item list shall be developed as part of the field inspection. Where no action items are required an acknowledgement of inspection is required at the end of the inspection. All parties present shall be noted and sign and date the inspection report.

### **2. Post Rainfall Inspections**

- Post Rainfall Inspections – It is recommended post rainfall inspections occur after any rainfall event with a total depth of 4.5 (approximately 10 year recurrence frequency) or greater or any event where incidents of flooding are reported. The inspection checklist shall be used with the addition of a Post Rainfall Report cover sheet. A post rainfall inspection should be completed within 3-5 days of the rainfall event. The rainfall amount shall be recorded from the nearest public rain gauge to the subdivision noting location of gauge, depth and distribution if available. The same gauge shall be utilized for any subsequent event. The procedure for the inspection and reporting shall be the same as for the Routine inspection.

### **3. Incident Inspection**

- Incident Inspection format & reporting - The inspection checklist shall be utilized for incident inspection of drainage infrastructure with the addition of an Incident Inspection cover sheet. An incident is a drainage complaint filed in writing, e-mail or personally with any HOA Board member. Any rainfall that causes surface overflows shall be followed with an incident inspection. The reporting shall be the same as for the Routine inspection.
- Incident Inspection response interval – Incident inspections shall have an inspection performed, a written response and disposition noted within 10 business days. Emergencies will require an immediate response but shall be documented through an incident report as well.
- Incident Inspection Procedure –An incident inspection is a limited inspection of the area where the incident is reported to have occurred. The inspection may continue upstream and downstream of the incident location to establish the condition of the system adjacent to the incident. An action item list shall be developed as part of the field inspection. Where no action items are required an acknowledgement of inspection is required at the end of the inspection. All parties present shall be noted and sign and date the inspection report.

**4. Annual Reporting** format – An annual report shall be prepared that quantifies and describes all inspections performed and actions necessary in response to the inspections. The primary purpose of the annual report is to identify budget needs. As a history is developed, trends for replacement of infrastructure or reduction in operation costs may become apparent. The annual report as well as the inspection / report log shall be sent (fax / e-mail) to Community staff.

**5. Inspector qualifications** –It is preferred to have an inspector with some construction / inspection experience even if it did not involve drainage infrastructure. It is also preferred that the HOA Engineer be involved during the initial inspections or on a bi-annual basis to audit inspection records and field conditions.

# Inspection Checklist

Subdivision Name \_\_\_\_\_ Date \_\_\_\_\_

By (all parties present) \_\_\_\_\_

Subdivision Outfalls \_\_\_\_\_ Stormwater Management Basins \_\_\_\_\_

Inspection Type  Routine  Post Rain  Incident

Special Management Areas  None  Wetland  Floodplain

## **Inspection Criteria**

### **Structures (S) - Inlets, Catch Basins, and Manholes**

1. Are all structures visible and accessible?
2. Are lids / grates missing / damaged / covered with debris
3. Is there surface ponding or settlement adjacent to the structures (in pavement)?
4. Is debris or roots present in structures (sediment / trash)
5. Is water surcharged (standing) above the outlet pipe elevation (invert)
6. Are structures "structurally" sound (cracks / holes / frame to structure condition)

### **Pipes (P) - Storm Sewer, Culverts and End Sections**

1. Are easements accessible for maintenance
2. Are trees / shrubs planted over the drainage pipes
3. Is there any settlement over pipes or culverts
4. Are driveway / roadway culverts "functional" free of trash / sediment / not crushed
5. Are safety grates in place where approved or required
6. Are culverts free draining (no standing water)
7. Are culverts in good condition (as best as can be seen)
8. Is erosion noted adjacent to end sections (rip-rap adequacy)

### **Flood Routes (F) - Swales, Ditches and Flood Routes**

1. Do swales and ditches have ponding water / settlement / obstructions (trees, debris, sediment)
2. Is there any erosion in the bottom or sides of the swales / ditches
3. Are swales / ditches adequately vegetated (70%)

### **Stormwater Facilities (D) and Special Management Areas**

1. Identify the type / function of the stormwater facility (dry, wetland, open water) and predominant vegetation (native, mowed) for each facility
2. Is there standing water and what is the "condition" (algae, oil, fish)
3. Is vegetation coverage > 70%. Note areas where this does not occur (location, size, native / non-native)
4. Is debris visible (trash, dead vegetation, sediment)
5. Is erosion visible (sideslopes, bottom). Note location and extent
6. What is the condition of the emergency overflow weir / route? Defined / per plan (materials, width, elevation), clear of debris / vegetation, adjacent settlement
7. What is the condition of the flow restrictor? Installed per plan (type, size, location, debris / sediment, access to restrictor for maintenance.
8. Does the stormwater facility contain an impoundment berm? If so check for trees on berm, animal burrows, seeps, erosion.
9. Note location and condition of fencing (does it restrict flows)?
10. Note location size and type of retaining walls. Is it leaning, cracking (where & width, & length), settlement / erosion.
11. Is the basin freely flowing from the outlet
12. Identify type of SMA (wetland, floodplain)
13. Identify observed encroachments into SMA (structure, trees, shrubs, debris (trash, grass clippings))

\* Note Field Plan number, structure or pipe number for reference

**Structures (S)** - Inlets, Catch Basins, and Manholes

1. Structures not visible or accessible

---

---

2. Structure lids / grates missing or damaged (note which)

---

---

Structure lids covered with debris

---

---

3. Surface ponding adjacent to the structures (note if in pavement)

---

---

Settlement adjacent to the structures

---

---

4. Debris or roots present in structures (note type i.e. sediment / trash)

---

---

5. Water surcharged (standing) above the outlet pipe elevation (invert)

---

---

6. Structural defects (cracks / holes / joint condition)

---

---

\* Note Field Plan number, structure or pipe number for reference

**Pipes (P) - Storm Sewer, Culverts and End Sections**

1. Easements not accessible for maintenance

---

---

2. Trees / shrubs planted over the drainage pipes (note which)

---

---

3. Settlement over pipes or culverts

---

---

4. Driveway / roadway culverts not free draining (standing water). Note trash, sediment, crushed

---

---

5. Safety grates missing where required

---

---

6. Structural defects in culverts (cracks, rust, etc.)

---

---

7. Erosion adjacent to end sections (rip-rap adequacy)

---

---

\* Note Field Plan number, structure or pipe number for reference

**Flood Routes (F) - Swales, Ditches and Flood Routes**

1. Ponding water / settlement / obstructions (trees, debris, sediment)

---

---

---

---

---

---

---

---

2. Erosion in the bottom or sides of the swales / ditches

---

---

---

---

---

---

---

---

3. Swales / ditches adequately vegetated (70%)

---

---

---

---

---

---

---

---

\* Note Field Plan number, structure or pipe number for reference

**Stormwater Facilities (D)**

1. Identify the number / location, type / function of the stormwater facility (dry, wetland, open water) and predominant vegetation (native, mowed) for each facility

---

---

2. Standing water and the “condition” (algae, oil, fish)

---

---

3. Is vegetation coverage > 70%. Note areas where this does not occur (location, size, native / non-native)

---

---

4. Debris (trash, dead vegetation, sediment). Note location and extent

---

---

5. Erosion (sideslopes, bottom). Note location and extent

---

---

6. Condition of the emergency overflow weir / route? Defined / per plan (materials, width, elevation), clear of debris / vegetation, adjacent settlement

---

---



\* Note Field Plan number, structure or pipe number for reference

7. Condition of the flow restrictor? Installed per plan (type, size, location, debris / sediment, access to restrictor for maintenance.

---

---

8. Does the stormwater facility contain an impoundment berm? Note trees on berm, animal burrows, seeps or erosion.

---

---

9. Note location and condition of fencing (does it restrict flows)?

---

10. Note location size and type of retaining walls. Is it leaning, cracking (where & width, & length), settlement / erosion.

---

---

---

---

11. Is the basin freely flowing from the outlet

---

---

\* Note Field Plan number, structure or pipe number for reference

**Special Management Areas (D)**

1. Identify location and type of SMA (wetland, floodplain)

---

---

2. Identify observed encroachments into SMA (structure, trees, shrubs, debris  
(trash, grass clippings)

---

---

\* Note Field Plan number, structure or pipe number for reference

## Incident Inspection Report

Subdivision Name \_\_\_\_\_ Date \_\_\_\_\_

Description of Incident

---

---

---

---

---

---

---

Reported by (name, address)

---

---

Reported to \_\_\_\_\_

Action Items (who, when, what is needed)

---

---

---

---

---

---

---

Inspection Performed By (all parties present) \_\_\_\_\_

---

---

Attach Inspection Checklist

## Post Rainfall Report

Subdivision Name \_\_\_\_\_ Date \_\_\_\_\_

By (all parties present) \_\_\_\_\_

Subdivision Outfalls \_\_\_\_\_ Stormwater Management Basins \_\_\_\_\_

Special Management Areas Present  None  Wetland  Floodplain

Date of rainfall (or range of dates) \_\_\_\_\_

Total rainfall depth (in.) for dates noted \_\_\_\_\_

Rainfall gauge location and source \_\_\_\_\_

Rainfall distribution available  Yes  No      Attached  Yes  No

Attach Inspection Checklist

## **E. Annual Maintenance Guidelines & Schedule**

### **1. Flushing, root cutting, cleaning and sediment removal**

Based on inspections it can be anticipated that cleaning of debris and sediment will be required to adequately maintain the capacity of the drainage system. This should be budgeted as an operating expense and will vary greatly depending on the type, extent and age of the drainage infrastructure. It may also be required to flush and / or root cut the storm pipe system to removed sediment accumulation. Records of work activities will assist with the budget and allow effective monitoring and inspection activities.

All cleaning and sediment removal activities shall be recorded by noting:

- Date of completion
- General description of work
- Specific pipe segment, structure, detention facility or drainage swale number
- Cost
- Contractor Name
- Comments on effectiveness and recommended recurrence

### **2. Vegetation management**

Management of vegetation is very important to maintain the capacity and design intent of the drainage system. There are two primary areas involving vegetation management.

HOA Maintenance responsibility - This is land owned by the HOA and/or which the HOA is responsible to maintain. These areas shall be identified on the Drainage Master Plan and Field Plans noted in section C. A written maintenance plan shall be developed identifying the following:

- Location of maintenance and type of vegetation (natural, turf grass, etc.)
- Description of Maintenance Activities
- Frequency of Maintenance Activities
- Cost
- Contractor

It should also be noted that maintenance may include supplemental planting of vegetation and erosion restoration. Record of these activities will assist in developing operating budget line items.

Non-HOA Maintenance responsibility - This is land not owned or maintained by the HOA and typically consists of overland flow swales and roadway ditches. Because the drainage system capacity is dependent on all elements of the system regardless of who has maintenance jurisdiction, the HOA should take a leadership role in identifying deficiencies and maintenance tasks to be performed by others. This includes, mowing, removal of scrub vegetation and debris, culvert repair and regulating new planting on or in the drainage system. The Community or Township Road District (in unincorporated areas) may have a role in maintaining roadway drainage and roadside ditches. Contact should be made by the HOA president (or other representative) advising him / her of the inspection activities and potential request for work activities. Tree roots can be a significant cause of drainage

system failure or flow reduction. Maintenance activities may be able to mitigate some of the root growth problems but ultimately tree removal may be necessary.

Formal contact with residents, the Community or Townships (in unincorporated areas) should be documented noting name of contact, date, concern, type of contact (phone, e-mail, etc.) and response or follow up action.

### **3. Stormwater Management Basin Maintenance**

A maintenance plan of regular and scheduled activities is important to keep the stormwater basins fully functional. An example chart of activities as well as an example maintenance plan is attached for reference and use.

### **4. Televising, lamping**

Lamping is a process where light is provided at one end of a pipe and observed at the other end. This process is simple and only determines that a pipe is open. In some situations this may be adequate to resolve a concern about the general function of the system; for example, as a response to an incident report. However lamping has limitations and where a more detailed inspection is required televising may be appropriate. Televising involves running a camera through the pipe to determine defects in the pipe system. Defects include pipe condition, joint condition, root intrusion, improper connections and pipe settlement. Televising also provides a good sense of the condition of the pipe and can assist in predicting pipe life and replacement requirements. Pending budget limitations it is recommended that systems that are 25 years or older have a representative sample (10%) of the system televised to provide a condition assessment and assist in capital replacement budgeting. If inspections or regular maintenance activities indicate there is a pipe or culvert problem that may require repair or replacement televising the pipe / culvert may also be necessary.

### **5. Operations budget**

An operations budget should be developed that includes the following considerations. It is recognized that drainage infrastructure maintenance is not a commonly recognized or understood activity or budget item. The intent is to determine budget needs/ line items or assign HOA Board responsibility.

- Drainage Infrastructure Maintenance Plan development
- Vegetation Maintenance
- Sediment Removal
- Televising
- Mapping & Plan Updates
- Routine Inspection
- Annual Report
- Emergency Repair Retainer
- Engineering Review

## F. Appendix

- **Applicability**

These guidelines are intended for use by Homeowners Associations of Kane County. These guidelines are intended to be resource for HOA's in maintaining and planning to maintain drainage infrastructure. It is not comprehensive in providing maintenance guidance and should not be the sole source of information for HOA's in their decision making process. These guides do not replace or represent in any manner or form engineering standards, practices or judgments. This document is intended to be revised and improved through use by HOA's, their engineer and the Community.
  
- **Definitions**
  1. **Base Flood Elevation:** The highest water surface elevation that can be expected during a flood having a 1% probability of being equaled or exceeded in a given calendar year.
  
  2. **Catch Basin:** A type of drainage structure (manhole) designed to retain debris that would not readily pass through the storm sewer system (i.e. a receptacle for street debris including leaves, dirt, garbage, street matter, etc.). Typically has an open grate / lid.
  
  3. **Community:** The Certified Community/Municipality who issued the Stormwater Management Permit for the development of the subdivision. In the case of unincorporated subdivisions, or subdivisions in non-certified Communities, the Community would be the Kane County Department of Environmental and Water Resources.
  
  4. **Culvert:** A drainage pipe extending across and beneath a traveled way and having a circular or box type cross section and allowing water to pass through the area without obstructing the roadway, sidewalk, etc. Typically the ends of the pipe are open and visible.
  
  5. **Detention Basin:** A storm water drainage facility, resembling a reservoir that acts as a rainfall runoff storage site which delays the flow of water downstream. Typically does not have a permanent pool of standing water.
  
  6. **Ditch:** A long, sometimes narrow, excavation, trench, or open passage way constructed to drain or channel rainfall runoff across land. Sometimes referred to as a swale.

7. Easement: A right held by an entity (property owner, person or agency/organization) to make use of another entity's property for a limited purpose, such as utilities, drainage ways, etc.
8. Field Tile: An underground pipe line installed for removing excess subsurface water from the soil typically intended for agriculture. Also referred to as drain tile or farm tile.
9. Floodplain: A nearly flat plain along the course of a stream, river or drainage way that is naturally subject to flooding (i.e. 1% annual chance or greater).
10. Floodway: The channel of a stream, river, or other watercourse and the adjacent land areas that must be reserved in order to pass the base flood elevation without increasing the water surface elevation more than a designated height (i.e. 0.1' for Kane County).
11. Jetting / Rodding: A means of pipe maintenance where high pressure water is used to clear a blockage or debris and sediment in a pipe. Often times accompanied by a flexible, mechanical cutting head to break up debris and root intrusions into a pipe drainage system.
12. Lamping: A means of inspection by shining a light at one end of a pipe and observing the same at the other end.
13. Inlet: A type of drainage structure (manhole), usually found at the beginning of a storm sewer system which collects water and directs it directly into the storm sewer pipe system. This type of structure has an open grate / lid.
14. Manhole: A type of drainage structure, usually with a closed cover, which acts as a junction or turning point in storm, sanitary, water, or electrical systems through which a person may enter to access the system for maintenance and inspection.
15. Outfall: The point of discharge for a storm sewer, detention basin, stream, river or other watercourse.
16. Overflow Route: A design feature of the drainage system which carries rainfall runoff which exceeds the capacity of the pipe system in an open channel or swale. These features are usually designed to withstand erosive forces.
17. Recurrence Frequency: The statistical likelihood of a rainfall event occurring within a one year time period. The "100 Year" event has a recurrence frequency of 100 years. This can be misleading because it really means that amount of rainfall has a chance of 1 in 100 (or 1%) of occurring annually. A "50 Year" event has a chance of 1 in 50 (or 2%) of occurring annually.



18. Retention Basin: A storm water drainage facility, resembling a reservoir that acts as a rainfall runoff storage site which delays the flow of water downstream. Typically has a permanent pool of standing water.
19. Rip Rap: Stone or broken concrete placed irregularly to act as protective bedding to prevent erosion.
20. Root Cutting: A means of pipe maintenance where a mechanical cutting head is utilized to cut and remove root intrusions into a pipe drainage system. Often times accompanied by high pressure water.
21. Storm Sewer: A series of underground pipes, manholes, inlets and catch basins for carrying rainfall runoff from paved surfaces, roofs, large ground space, etc. to a stormwater management basin or defined drainage way (swale, ditch, river, stream).
22. Surcharge: When the amount of rainfall runoff exceeds the capacity of the storm sewer system or culvert and begins to back up into the system /culvert. Water may flow out of storm structures normally intended to drain a particular area.
23. Swale: A long, sometimes narrow, excavation, trench, or open passage way constructed to drain or channel rainfall runoff across land. Sometimes referred to as a ditch.
24. Televising: A technique used to evaluate the condition of storm sewer pipes and culverts through the use of a small camera and lighting system to visually record conditions.
25. Tributary Area: An area of land that drains to a given point in the drainage system (a storm structure such as a inlet, catch basin, etc.) or a stormwater basin.
26. Underdrain: A shallow perforated underground pipe which drains subsurface water and can aid drainage of surface water on very flat land areas through the soil.
27. Wetland: A lowland area that can have regulatory restrictions and requirements from Kane County and / or the United States Army Corps of Engineers. These low areas provide water quality and quantity benefits through natural biological processes. Generally wetlands are considered present if three factors are favorable; soils, hydrology (water) and plant species.



# LONG TERM STORMWATER FACILITY MAINTENANCE

## CERTIFIED COMMUNITY INSPECTION FORM

Subdivision Name \_\_\_\_\_

Date of Inspection \_\_\_\_\_

Name of Responsible HOA Representative \_\_\_\_\_

Contact Number for HOA \_\_\_\_\_

Stormwater Permit Number \_\_\_\_\_ Date Issued \_\_\_\_\_

Weather Conditions During Inspection \_\_\_\_\_

Inspector to note locations where issues exist on the plan sheet that accompanies this report. The plan sheet shall be scanned as a digital record for the subdivision.

### Minor Stormwater System (storm sewers, inlets, catchbasins, manholes)

1. Are the easements for the minor stormwater system accessible for maintenance?

100%       75%       50%       25%       <25%       N/A

2. Are there trees planted over the stormwater lines in the easements?

100%       75%       50%       25%       <25%       N/A

3. Are the inlets, catchbasins and manholes accessible (indicate percentage)?

100%       75%       50%       25%       <25%       N/A

4. Are any lids or grates missing or damaged? (indicate location on plan sheet)

5. Are the inlet and catchbasin grates free of debris (indicate percentage)?

100%       75%       50%       25%       <25%       N/A

6. Are the sumps and bottoms of the manholes, inlets and catchbasins clean?

100%       75%       50%       25%       <25%       N/A

7. Is the water (if any) free flowing (indicate surcharged manholes on plan)?

100%       75%       50%       25%       <25%       N/A

8. Is there root intrusion into the manholes?

100%       75%       50%       25%       <25%       N/A

9. Are the manholes structurally sound?

100%       75%       50%       25%       <25%       N/A

10. Note location of any surface ponding around manholes or over storm sewer pipes or sinkholes on the drawing.

**Major Stormwater System (culverts, swales, flood routes)**

1. Are culverts free of debris?

100%       75%       50%       25%       <25%       N/A

2. Are debris guards in place where indicated on the plan?

100%       75%       50%       25%       <25%       N/A

3. Are Flared End Sections/Headwalls in place where indicated on the plan?

100%       75%       50%       25%       <25%       N/A

4. Are the Flared End Sections/Headwalls in good condition?

100%       75%       50%       25%       <25%       N/A

5. Are the culverts structurally sound?

100%       75%       50%       25%       <25%       N/A

6. Are swales and ditches located where shown on the plan?

100%       75%       50%       25%       <25%       N/A

7. Are swales and ditches properly vegetated?

8.  
 100%       75%       50%       25%       <25%       N/A

9. Is any erosion noted on swales and ditches?

100%       75%       50%       25%       <25%       N/A

10. Are swales and ditches properly draining water?

100%       75%       50%       25%       <25%       N/A

11. Are there any obstructions in the swales and ditches?

100%       75%       50%       25%       <25%       N/A

12. Are flood routes where indicated on the plans?

100%       75%       50%       25%       <25%       N/A

13. Are there any obstructions within the flood routes?

100%       75%       50%       25%       <25%       N/A

### **Detention Facilities**

1. What type of detention facility does this subdivision have?

Dry bottom with sod     Dry bottom native plantings     Wetland Bottom sod slopes

Wetland Bottom w/ native slopes     Open water w/ sod slopes

Open water with native slopes

2. Is the detention facility approximately the size and location shown on the approved plans?

Yes     No

3. Are there retaining walls?  Yes     No      If YES indicate the condition of the wall (look for areas behind the wall of failures, misaligned block, etc)

Good       Fair       Poor

4. Is the basin sufficiently vegetated?  Yes     No

5. Does the type and species of vegetation match the planting plan?  Yes     No

6. In the case of wetland and natural plantings is there diversity?  Yes     No

7. Is there a buildup of dead vegetation?  Yes       No

8. Is there erosion on the side slopes?  Yes     No

9. What is the amount of sediment buildup in the retention area?

100%       75%       50%       25%       <25%       N/A

10. Is the overflow weir as shown on the plans and free of debris or blocked by vegetation?

Yes     No

11. Are inlet and outlet pipes clean and free of debris?

Yes     No

12. Is the restrictor the size and shape as approved on the plans?

Yes     No

13. Is the restrictor and manhole clean and free of debris?

Yes     No

14. Is the detention basin discharge freely flowing?

Yes     No

**Special Management Areas**

1. Are there any wetland or floodplain areas within the subdivision (includes creeks)?

Wetland     Floodplain     Both

2. Are the areas on open space parcels maintained by the HOA?

Yes     No

3. Are there any encroachments into the special management areas?

Yes     No     N/A

4. Are the special management areas being maintained

Yes     No     N/A

**Record Keeping**

1. Does the HOA have a record of the maintenance performed on the stormwater systems on a yearly basis?

Yes     No     N/A

2. Does the HOA have a copy of the maintenance and planting plan filed with the original stormwater permit?

Yes     No     N/A

3. Who has the HOA contracted with to perform the maintenance duties?

---

---

---

**Acknowledgement**

I, \_\_\_\_\_, being a designated representative of the Homeowner's Association for \_\_\_\_\_ Subdivision witnessed on this day \_\_\_\_\_ the inspection of the stormwater facilities in our subdivision by \_\_\_\_\_. I understand that \_\_\_\_\_ will complete a final report on the inspection and will send the report to the Homeowner's Association at the following address:

\_\_\_\_\_

It is understood that the Homeowner's Association will be provided, in the report, a reasonable time frame for compliance given the time of year and severity of the issues. If this timeframe is not met, \_\_\_\_\_, at its sole discretion will activate the backup SSA to complete such maintenance as necessary to ensure the proper operation of the stormwater facilities.

\_\_\_\_\_  
Signature HOA Representative

\_\_\_\_\_  
Signature Inspector

# KANE COUNTY REQUIREMENTS FOR STEEP SLOPE ZONES

## CONSTRUCTION ON AND MAINTENANCE OF STEEP SLOPE ZONES

### 1. Definitions.

**For purposes of this chapter, the following definitions shall apply:**

*Aggregate diameter.* The combined diameter of a multiple trunk tree measured at diameter breast height.

*Bottom, or toe, of slope.* The line formed by the base of a steep slope.

*Construction Activities.* Any activity that involves the construction or demolition of any structure of any nature whatsoever or the disturbance, excavation or placement of soil in sufficient quantities to change soil contour at any location by a depth of more than six inches, or removal of any desirable or protected tree.

*Desirable Species.* Any species of tree belonging to any of the following genera:

<u>Genus</u>	<u>Common Name</u>
<i>Juglans</i>	Walnut
<i>Carya</i>	Hickory
<i>Celtis</i>	Hackberry
<i>Tilia</i>	Basswood
<i>Quercus</i>	Oak
<i>Gymnocladus</i>	Kentucky Coffeetree

*Diameter breast height or "DBH".* The diameter of a tree measured at four and one-half feet (4-1/2') above the highest point of the existing grade at the base of the tree.

*Drainage line.* A pipe, tile, ditch or other similar manmade means of accomplishing the removal of surface and/or subsurface water.

*Erosion.* The process whereby soils are transferred from place to place by the movement of wind or water.

*Protected tree.* Any living tree of a desirable species having a diameter of eight inches (8") DBH or larger or having an aggregate diameter of fifteen inches (15") DBH or larger.

*Ravine.* A gully or gorge worn by the flow of water in a regularly or intermittently flowing waterway.

*Remove or removal.* The actual physical removal of a tree, or the effective removal through intentional damaging, poisoning, or other direct or indirect intentional action resulting in, or likely to result in, the death of a tree.

*Restoration.* The re-establishment of the grade, slope, stability, vegetation, or drainage systems of disturbed property in a steep slope zone by bringing the property back to substantially the same condition as existed prior to disturbance.

*Steep slope.* Land with a slope which equals or exceeds a vertical rise of one foot for a horizontal run of three feet for a vertical height of 10 feet or more.

*Steep slope zone.* All land which lies between the bottom of a steep slope and a line twenty (20) feet beyond the top of a steep slope into the adjoining tableland.

*Tableland.* An elevated region with a low relief surface and with at least one border defined by more or more steep slopes.

*Top of steep slope.* The line formed by the top of a steep slope.

*Tree.* A self-supporting, woody plant, together with its root system, having a well defined stem or trunk or a multi-stemmed trunk system, a more or less well defined crown, and a mature height of at least fifteen feet. "Tree" shall not include trees in containers or nursery stock trees maintained for resale.

*Undesirable species.* Are those species of tree considered by arborists to be invasive, nonnative, and/or shallow-rooted, including, but not limited to, buckthorn, Norway maple, raspberry, honeysuckle, mulberry, box elder, black locust, Chinese elm, Siberian elm, tree of heaven and willow.

## **2. Limitation on construction in and development of steep slope zones.**

Except as authorized in this Chapter, no construction activities may be undertaken or continue in a steep slope zone. Steep slope zones shall remain vegetated in the natural state. Any steep slope zone disturbed for any reason including the commencement of any authorized or unauthorized construction activities shall be restored by planting appropriate native vegetation. Whenever construction activities occur upon property abutting a steep slope zone, erosion control measures prescribed in this document shall be placed along the limit of the steep slope zone and maintained during any construction activities.

## **3. Maintenance of property in a steep slope zone.**

Owners of real estate within or adjacent to a steep slope zone shall properly maintain drainage lines that convey storm water generated by manmade structures on such property either to a public storm sewer or to the base of the steep slope. Private drainage lines shall not leak water onto the surface of a steep slope zone. Lawn waste or other debris shall not be placed in a steep slope zone and if placed shall be removed.

## **4. Development of property which includes steep slopes.**

An easement shall be recorded over any steep slope zones identified through permitting process for the construction of new single family homes to ensure the protection of the steep slope zone, long-term maintenance of drainage lines and other measures designed to reduce erosion.

## **5. Structures and activities authorized within a steep slope zone.**

The following construction activities are permitted within a steep slope zone subject to prior issuance of a building permit and subject to conformance with the standards established in this document and the bylaws:

(a) Legal non-conforming structures may be maintained or rebuilt subject to the provisions of the Permit Authority's Codes.

(b) Bridges, walkways, steps, landings, and/or fences which do not obstruct the flow of light or water, and utility service lines. Stairs constructed in the steep slope zone shall be no greater than five feet in width. Landings constructed in the steep slope zone shall be no larger than five feet by ten feet. A joint permit must be obtained from the Army Corp of Engineers if the construction falls within an area of their jurisdiction.



(c) Emergency action to remediate an unstable or insecure slope which poses an imminent threat to the health, safety, or welfare of the public, provided further that the remedial action involves the least possible disruption of the natural features of the site and conforms as nearly as possible with the standards and policies of this document.

(d) Normal landscape maintenance or routine arboreal activities, including small scale planting of ornamental flowers or shrubs, and/or the removal of diseased, dead or damaged trees of any species, and/or the removal of undesirable trees provided such activities include revegetation in conformance with the standards contained in this chapter. Prior to removal of stumps and fallen trees, consideration should be given to whether the woody materials are acting in a manner that is providing slope stability and toe of slope protection. These natural systems may be acting as a ditch check dam that is preventing further undercutting of the ravine or stabilizing the side slope. If in doubt, a property owner should contact the Permit Authority or a professional in woodland management for advice prior to removal of fallen trees or stumps.

(e) Extensions of structures such as balconies or decks provided that such extension is not supported by any structure or foundation located within the steep slope zone. However, no part of any such structure may extend more than one foot into the steep slope zone for each three (3) feet of height.

(f) Public improvements and infrastructure constructed by the utility company or other units of federal, state or local government.

(g) Other accessory structures having a total ground cover area not exceeding 100 square feet.

(h) Small scale erosion control structures such as check dams not exceeding a height of three feet and riprap or other structural erosion control methods. Note that a joint permit from the Army Corp of Engineers may be required.

(i) Every application to undertake construction activities within a steep slope zone shall include the submission of a report prepared by a licensed professional civil/structural engineer trained and experienced in the practice of geotechnical engineering. The report shall cover affected portions of the steep slope zone where construction is proposed together with all adjoining areas in the tableland located beyond the top of the steep slope zone but within 30 feet thereof. The report shall include the following:

1. Soil Types and Subsurface Materials Investigation. This Investigation shall at a minimum consist of: a thorough subsurface investigation using techniques such as borings, test pits, *in situ* tests, laboratory tests or other procedures performed to a depth sufficient to determine foundation conditions for the proposed construction; and a description of the soil and subsurface materials found on the subject site to a depth extending below any proposed excavation as well as the engineering properties of the subsurface soil materials.

2. A written description of the proposed means and methods of accomplishing such work, which means and methods shall be carefully selected to minimize slope damage. In the case of any proposed structure, the means and methods shall include plans and specifications for construction including, without limitation, a foundation plan which takes into account the conditions identified through the soil types and subsurface materials investigation. Upon approval of a building permit for the structure, such written description shall be the enforceable means and method of construction.
3. Geotechnical Characteristics. A discussion of geotechnical characteristics which shall at a minimum include the following: consideration in the design of all proposed structures shall be given to the effect of undercutting at the base of Steep Slopes, storm water flow, and erosion and/or channel changes; a description of the stability of surface patterns of water flow as well as indication of the presence or absence of permeable zones in underlying soils and susceptibility of slope instability due to changes in the water table; an opinion that the soil types, soil stability, subsurface hydrology, and external influences affecting the site will not cause any significant hazards for the proposed use; or if they may cause such hazards, an opinion that such hazards can be overcome, together with a reasonably detailed description of how it is proposed to overcome them.
4. Earth Moving Plan. An earth moving plan which complies with the provisions of section 6(c) of this chapter which plan shall at a minimum include the following: a topographic survey, showing property contours at one foot intervals for tableland and five (5) foot intervals for Steep Slopes, including special notes and details of the existing terrain; Proposed earth moving details, including the dimensions, elevations, and contours of any proposed earth moving and the placement of excavated materials; A description of the methods to be employed in disposing of soil and other material removed, including the location of the disposal site; A time-table for commencement and completion of each stage of the project; and a provision requiring where appropriate the placement of a temporary construction perimeter fence on the tableland at the top edge of Steep Slope Zone until construction is completed.
5. Hydrological Control Plan. A plan for intercepting and containing drainage at the site and from any structure which plan complies with section 6(a) of this chapter.
6. Vegetation Plan. A vegetation plan which complies with the provisions of 6(b) of this chapter prepared or approved by a landscape professional, which plan shall at a minimum include the following: An inventory describing the existing floral and tree cover of the site, including identification of undesirable species and protected trees showing those areas where the vegetation will be removed as part of the proposed development; a description of proposed revegetation of disturbed areas, specifying the materials to be used; a written description detailing methods of slope stabilization and revegetation; planting techniques proposed to be used; and a maintenance guideline, instructing owners of the site of necessary actions to maintain plantings.

## **6. Development standards.**

Construction and/or earth moving within a steep slope zone and within the watershed of a steep slope zone shall occur in accordance with the following standards:

### **(a) Hydrological Controls.**

1. **Natural Channels.** Natural drainage ways shall be preserved to the maximum extent possible.
2. **Controlled Run-Off.** Concentrated run-off from impervious surfaces shall be conveyed away from a steep slope to a storm sewer system if available, or through grassed swales, infiltration trenches or other sound engineering practices designed to infiltrate stormwater runoff and minimize erosion. If infiltration is not deemed appropriate, concentrated runoff from impervious surfaces shall be collected and transported in drainage lines. Stormwater pipes conveying concentrated runoff to the bottom of a steep slope shall generally be located above ground, but may be located below ground with the approval of the Permit Authority. Sump pump drain lines shall be connected to a storm sewer system if located within 250 feet thereof. If no storm sewer is available, sump pumps shall discharge into a rain barrel or rain garden.
3. **Interceptor Ditches.** When sound engineering practice dictates, interceptor ditches shall be established outside of Steep Slope Zones in order that soil shall not become saturated and the intercepted water shall be conveyed in a pipe or other approved manner to a storm sewer system, if available, or to the bottom of a slope in a manner designed to minimize erosion.
4. **Discharge Point Stabilization in Steep Slopes.** Natural drainage ways shall be stabilized by landscape integration, rip-rap, rolled erosion control products or other means consistent with sound professional engineering practice, to a distance below drainage and culvert discharge points sufficient to convey the discharge while minimizing channel erosion and in such a manner as to dissipate the energy of the discharge.
5. **Early Completion.** The overall drainage system shall be completed and made operational at the earliest possible time during construction.
6. **Impact on Adjacent Property.** The natural or usual flow of surface or subsurface water shall not be altered or obstructed by grade changes in any way that may adversely affect the property of another by either contributing to pooling or collection of waters or to the concentration or intensification of surface water discharge. However, construction which might otherwise be prohibited hereinabove may be allowed if such waters are properly drained by a pipe or other approved manner to a municipal storm sewer system, if available, or to the bottom of the steep slope.

### **(b) Vegetation and Revegetation.**

1. **Natural Vegetation.** Every effort shall be made to maintain natural vegetation in a steep slope zone.
2. **Smallest Area.** When construction activities are authorized in a steep slope zone, the smallest practical area of raw soil shall be exposed for as short a duration of time as practical. When sound engineering practice dictates or

- when required by the HOA, temporary vegetation, or other acceptable cover shall be used to protect areas of raw soil exposed during construction.
3. Revegetation. A mixed planting of perennial and woody species (preferably native species with adequate deep root systems) shall be used to landscape disturbed areas in a steep slope zone.
  4. Tree removal. It shall be unlawful to remove any protected tree from a steep slope zone without the approval of the Permit Authority.
  5. Long term management. The Permit Authority shall encourage the owners of property containing Steep Slope Zones including, in particular, those who apply for permits to undertake construction activities as authorized under the provisions of this chapter, to learn and implement the most current techniques for the management of the forested areas of the Steep Slope Zones in accordance with the best available scientific information.

(c) Earth Moving.

1. Minimum Alterations. Earth moving shall be limited to the minimum required for building foundations, driveways, drainage control structures, and immediate yard areas.
2. Erosion Control. All earth moving shall be accomplished in a manner which will create the lowest possible potential for erosion.
3. Soil Fill on Steep Sloped Land. All fill in a steep slope zone is prohibited, other than back-fill to be necessary for slope stabilization.
4. Prompt Completion. All earth moving shall be accomplished in the shortest practical period of time. All excess excavated material shall be removed from the steep slope zone and no temporary or permanent storage of material shall be permitted within the steep slope zone. No existing natural vegetation shall be destroyed, removed or disturbed prior to the initiation of earth moving activities.



# KANE COUNTY 50% RULE

## SUBSTANTIAL IMPROVEMENT, SUBSTANTIAL DAMAGE AND MAINTENANCE

---

### NOTICE TO PROPERTY OWNERS

*Adding on, renovating, remodeling, repairing or rebuilding your home?  
Here's information **YOU** need to know about the "50% Rule".*

If your structure has experienced substantial damage, there are regulations that may affect the reconstruction or use. If your structure is below the 100-year flood elevation, there are flood damage prevention regulations that may affect how you remodel, renovate, or add on to your building. This is required by Kane County and the National Flood Insurance Program to protect lives and investment from future flood damages. The County must adopt and enforce these laws in order for federally-backed flood insurance to be made available to residents and property owners.

### SAVE YOURSELF TIME AND MONEY!

#### PLEASE READ THE FOLLOWING INFORMATION:

**SUBSTANTIAL DAMAGES OR SUBSTANTIALLY DAMAGED:** Damage caused by one or more events to a Building located in the Floodplain or Floodway from any cause (examples include, but are not limited to, fire, Flood, earthquake) on or after January 1, 2010, whereby the cumulative cost to date plus the cost of restoring the Building to its original condition from the event or events occurring after January 1, 2010, is fifty percent (50%) or more of its Market Value, regardless of the actual repair work performed. The Market Value of volunteer labor and materials must be included in this determination. The cumulative total of Substantial Damages shall be tied to the property.

**SUBSTANTIAL IMPROVEMENTS OR SUBSTANTIALLY IMPROVED:** Any reconstruction, rehabilitation, addition, or other improvement of a Structure, the cumulative cost to date plus the cost of which equals or exceeds 50 percent of the Market Value of the Structure before the "start of construction" of the improvement. This term includes Structures which have incurred "Substantial Damage," regardless of the actual repair work performed, and as otherwise determined by the Certified Community in accordance with NFIP standards.

**MAINTENANCE OF EXISTING BUILDINGS:** Maintenance tasks that do not result in any increases in the outside dimensions of a Building or changes to the dimensions of a Structure. Maintenance tasks include any work completed to correct existing violations of state or local health, sanitary or safety codes identified and determined by the local code enforcement official to be the minimum necessary to assure safe living conditions. Additionally, these tasks shall include, but are not limited to, re-roofing, the replacement of windows, water heaters, and furnaces, the repair of existing plumbing, and the re-wiring of an existing electric service.

**BUILDING MARKET VALUE:** The market value or replacement cost will be estimated by using three (3) times the current tax assessed value of the subject structure (excluding the land and exterior

construction). A certified appraisal prepared by a state licensed appraiser, completed within the last two years, and based on the comparable sales method may be used to determine the value of the structure prior to any construction or damages. The building value must be fairly depreciated to reflect the age of the building and the deterioration of building components. Replacement costs may only be used if properly depreciated.

**APPLICABILITY:**

Our community, following Kane County regulations and the National Flood Insurance Program requirements, has the responsibility to determine "substantial damage" and "substantial improvement", and has implemented the procedures on the following pages to do so. Items that are to be included in the substantial damage/improvement calculation are as follow:

- A. Any improvement or a series of improvements or addition (less than 20% of floor area\*) made to a Structure located in the Floodplain or Floodway on or after January 1, 2010;
- B. Reconstruction or repair of a Structure located in the Floodplain or Floodway due to Damage on or after January 1, 2010;
- C. Maintenance to Existing Buildings located in the Floodplain or Floodway within the last ten (10) year period beginning on January 1, 2010;

The cumulative percentage of improvements is tied to the property beginning on January 1, 2010, and the cumulative percentage of tasks required to perform Maintenance of Existing Buildings shall be recorded over a rolling, ten (10) year period, beginning on January 1, 2010. The following costs should **NOT** be included in the cumulative percentage calculation: a) any work done to a Structure to correct existing violations of state or local health, sanitary or safety codes identified and determined by the local code enforcement official to be the minimum necessary to assure safe living conditions; or b) any work done to a Structure listed on the state or federal historic register provided that alteration will not preclude the Structure's continued designation as a historic Structure.

\*additions over 20% of floor area are considered a Substantial Improvement regardless of cost

**PROCESS:**

Obtain and submit a detailed cost estimate and complete the Estimated Cost Form for the addition, remodeling, reconstruction, repair or maintenance of your structure. The Estimated Cost Form should be submitted with your Building Permit Application.

We will evaluate the cost of construction or repairs based on recognized cost estimating manuals and determine if they are complete and accurate and reflect current construction market cost for labor and supplies. For damage repairs, pre-damage prices and rates will be utilized. The cost of construction or repairs does not include items not considered a permanent part of the structure. (i.e., plans, surveys, permits, see list of "Items to be Excluded" on the following page).

The Building Market Value will be determined using the current tax assessed value of the structure and a determination form will be filled out based on the information explained above. This form will need to be signed and notarized with confirmation of your acceptance of the determination.

If you do not accept the determination you then have the option of submitting a certified appraisal prepared by a state licensed appraiser, completed within the last two years, and based on the comparable sales method may be used to determine the value of the structure prior to any construction or damages.

If the determination shows that the proposed damages or construction are greater than 50% of the market value of the structure it may impact your ability to complete the work to the structure as originally proposed (more detail on the following page).

**FOR STRUCTURES WITHIN THE FLOODPLAIN:**

If a building is determined to be "substantially damaged" or "substantially improved", it must be brought into compliance with the Building Protection Standards of the Kane County Stormwater Management Ordinance (SMO).

**IMPORTANT NOTE ON DONATED MATERIALS AND VOLUNTEER LABOR:**

The value placed on materials should be equal to the actual or estimated fair market cost of all materials to be used. Where materials or servicing equipment are donated or discounted below normal market values, the value should be adjusted to an amount equivalent to that estimated through normal market transaction.

Self or Volunteer Labor: The value placed on labor should be equal to the actual or estimated labor charge for repairs of all damages sustained the structure. Where non-reimbursed (volunteer) labor is involved, the value of the labor should be estimated based on applicable published hourly wage scales, for example using prevailing wages for the type of construction work to be completed.

**ITEMS TO BE EXCLUDED**

- Plans and specifications
- Survey costs
- Permit fees
- Driveways
- Demolition
- Debris removal (e.g., removal of debris from building or lot, dumpster rental, transport fees to landfill and landfill tipping fees), and clean-up (e.g., dirt and mud removal, building dry out, etc.)
- Fences
- Landscaping
- Sidewalks
- Yard lights
- Landscape irrigation systems
- Items not considered real property such as: throw rugs (carpeting over finished floors), furniture, refrigerators, appliances which are not built-in, etc.

**REQUIRED TO EVALUATE YOUR BUILDING PERMIT APPLICATION:**

**Estimated Cost Form** of reconstruction/improvement form (included in package) and all required backup. Include subcontractor's bids and itemized cost lists. One (1) Estimated Cost Form shall be submitted for each impacted structure.

**REQUIRED BEFORE OCCUPANCY OR FINAL INSPECTION:**

**Determination Form** signed, notarized and dated (to be provided by staff once review is complete)

ESTIMATED COST FORM			
STRUCTURAL ELEMENTS	LABOR	MATERIAL	TOTAL COST
<b>EXCAVATION</b> (Ex: prep work, gravel base)			
<b>FOUNDATION</b> (Ex: monolithic slabs, piers, spread footing, CMU, ICF, wood)			
<b>DAMPROOFING, WEATHERPROOFING, TILE, FOUNDATION INSULATION</b>			
<b>FLOOR SYSTEMS</b> (Ex: trusses, lumber, steel, concrete, in-floor heat, vapor barrier)			
<b>BEAMS</b> (Ex: steel, wood, pre-engineered, columns)			
<b>WALLS, FRAMING (EXTERIOR &amp; INTERIOR)</b> (Ex: wood, metal, sheathing)			
<b>CEILING, RAFTERS, TRUSSES</b>			
<b>ROOFING SYSTEM</b> (Ex: sheathing, felt, ice & water shield, asphalt, wood shake, tile, clay, metal, shingling, venting)			
<b>EXTERIOR WALL COVERING</b> (Ex: lap siding, vinyl, aluminum, brick, stucco, house wrap shutters)			
<b>WINDOWS</b> (Ex: escape window, double-hung, casement, slider, awning)			
<b>WOOD DECKS (EXTERIOR &amp; INTERIOR)</b>			
<b>INSULATION</b> (Ex: walls, floors, roof)			
<b>HARDWARE</b> (Ex: door hardware, nails, screws, brackets, handrails)			
INTERIOR FINISH ELEMENTS	LABOR	MATERIAL	TOTAL COST
<b>FLOORING</b> (Ex: tile, linoleum, stone, laminate, wood, carpet, sub-flooring)			
<b>WALL FINISHES</b> (Ex: drywall, plaster, stucco, paneling, stone, paint, tape, mud)			
<b>BUILT-INS, CABINETRY</b> (Ex: bookcases, entertainment centers, kitchen cabinets, countertops, built-in stove, vanities, furniture)			
<b>DOORS (EXTERIOR &amp; INTERIOR)</b> (Ex: side-hinged, sliding, pocket, bi-fold)			
<b>HARDWARE</b> (Ex: interior door hardware, screws, nails, handrails)			
UTILITY & SERVICE EQUIPMENT	LABOR	MATERIAL	TOTAL COST
<b>HVAC</b> (Ex: furnace, a/c unit, baseboard heat, radiant heat, duct-work venting, registers, material associated with system)			
<b>PLUMBING</b> (Ex: fixtures, faucets, tubs, showers, toilets, sinks, material, venting, water heater, sump & ejector pumps)			
<b>ELECTRICAL</b> (Ex: panel, wiring, boxes/outlets, switches, light fixtures, fans, raceway, etc.)			
<b>CENTRAL VACUUM SYSTEM</b>			
<b>WATER FILTRATION CONDITIONING OR RECIRCULATING SYSTEM</b>			
<b>FIREPLACE</b> (Ex: hearth, stone, brick, chimney, vent, mantel)			
OTHER	LABOR	MATERIAL	TOTAL COST
<b>TOTALS</b>			

\_\_\_\_\_  
Property Owner or Contractor's Signature



# SUBSTANTIAL IMPROVEMENT OR SUBSTANTIAL DAMAGE

---

## Determination

Permit Number: \_\_\_\_\_

Permit Type (check):    Repair     Improvement     Maintenance

Owner or Contractor's Cost Estimate: \_\_\_\_\_

Certified Community Review of Cost Estimate:                      Reviewed by: \_\_\_\_\_

- Cost provided by Owner/Contractor is a reasonable estimate for work performed
- Cost provided by Owner/Contractor is not a reasonable estimate for work performed and should be adjusted as follows: \_\_\_\_\_  
\_\_\_\_\_

Building Market Value: \_\_\_\_\_

Percentage of repair, improvement or maintenance for above Permit: \_\_\_\_\_

Base Flood Elevation: \_\_\_\_\_      Flood Zone \_\_\_\_\_

### Cumulative Percentage Calculation:

Percentage of repair, improvement or maintenance for above Permit \_\_\_\_\_

Cumulative percentage of repair and/or improvements (since January 1, 2010 excluding permit above) \_\_\_\_\_

Cumulative percentage of maintenance occurring in the last 10 years (excluding permit above) \_\_\_\_\_

**TOTAL CUMULATIVE PERCENTAGE** \_\_\_\_\_

- I accept the estimated cost of construction as a fair cost of the repair/improvement of my home.
- I accept the estimated market value from the tax assessment
- I do not accept the estimated market value from the tax assessment and will submit an appraisal report of my property from a licensed appraiser.

\_\_\_\_\_  
Property Owner's Signature

Sworn to and subscribed before me this \_\_\_\_\_ day of \_\_\_\_\_, 20\_\_\_\_.

\_\_\_\_\_  
NOTARY PUBLIC

**DEVELOPER'S STATEMENT**

Right to Draw on Securities  
Section 1201.1 (c & d) & 1202.1.b

I, \_\_\_\_\_, do hereby grant to the Administrator of \_\_\_\_\_  
Developers Name County/Municipality

The right to draw on performance security posted in accordance with the Storm  
Water Permit \_\_\_\_\_ for the purpose of completing any and all  
(Number/Description)  
Stormwater Facilities and completing or maintaining Sediment and Erosion Control  
Measures included in the referenced permit. The decision to draw on the security  
shall be at the discretion of the Administrator. I further grant the right to enter the  
property for the purpose of performing the work to whoever the Administrator  
designates and agree to identify \_\_\_\_\_ against any increased costs  
County/Community  
attributable to concurrent activities or conflicts between the Administrators design's  
and any other contractors on site. I further warrant that I am a duly authorized  
representative of the developer with the authority to make this statement, and that  
this statement shall remain binding until final inspection and acceptance of all  
permitted Stormwater Facilities.

STATEMENT FOR: \_\_\_\_\_  
Developer

BY: \_\_\_\_\_  
Name and Signature

TITLE: \_\_\_\_\_

**RELEASED BY FINAL ACCEPTANCE**

FOR: \_\_\_\_\_  
County/Community

BY: \_\_\_\_\_  
Administrator

DATE: \_\_\_\_\_

Declaration of Restriction and Covenant for Linear Watercourse, Non-Linear Waterbody, Wetland and Wetland Buffer Areas

STATE OF ILLINOIS )

) SS:

COUNTY OF KANE )

**LINEAR WATERCOURSE, NON-LINEAR WATERBODY, WETLAND AND WETLAND BUFFER AREAS RESTRICTIVE COVENANT BY PLAT**

\_\_\_\_\_, fee owner of the following described real property located in the \_\_\_\_\_, County of Kane, State of Illinois, such property being the real property now duly platted as \_\_\_\_\_, as such plat is now recorded as Document No. \_\_\_\_\_, in the office of the Recorder of Deeds of the County of Kane, State of Illinois, makes the following declarations as to limitations, restrictions and uses to which those areas designated as LINEAR WATERCOURSE, NON-LINEAR WATERBODY, WETLAND AND WETLAND BUFFER AREAS in said parcel/subdivision may be put, and specifies that such declarations shall constitute covenants to run with all the land, as provided by law, and shall be binding on all parties and their successors, and all persons claiming under them, and for the benefit of and limitations on all future owners in such parcel/subdivision and the surrounding and downstream and upstream areas, this declaration being in compliance with applicable stormwater and drainage rules, regulations, and ordinances as specified herein:

1. **Purpose:** The purpose of this restrictive covenant is to perpetually preserve the linear watercourses, non-linear waterbodies, wetlands and their associated buffers in their natural condition. The obligations established by USACE Permit #: \_\_\_\_\_ and Stormwater Management Permit # \_\_\_\_\_ shall run with the land and remain in effect in perpetuity, or until said permit is modified, altered or terminated by a subsequently issued permit for the Subject Property.
2. **Prohibited Actions.** Any activity on, or use of, the linear watercourses, non-linear waterbodies, wetlands and their associated buffers which is inconsistent with the purpose of this covenant is expressly prohibited. By way of example, but not by way of limitation, the following activities and uses are explicitly prohibited:
  - i. Division. Any division or subdivision of the linear watercourses, non-linear waterbodies, wetlands and their associated buffers areas is prohibited.
  - ii. Commercial Activities. . Any commercial activity on the linear watercourses, non-linear waterbodies, wetlands and their associated buffers

areas is prohibited. De minimis commercial recreational activity is, however, permitted.

- iii. Industrial Activities. Any industrial activity on the linear watercourses, non-linear waterbodies, wetlands and their associated buffers is prohibited.
- iv. Construction. The placement or construction of any human-made modification such as, but not limited to, buildings, fences, roads, and parking lots is prohibited unless a permit has been obtained.
- v. Cutting Vegetation. Any cutting of trees or vegetation, including pruning or trimming, is prohibited, except for the cutting or removal of trees or vegetation which pose a threat to human life or property or is part of the permitted long-term management plan.
- vi. Land Surface Alteration. Any mining or alteration of the surface of the land is prohibited, including any substance that must be quarried or removed by methods that will consume or deplete the surface estate, including, but not limited to, the removal of topsoil, sand, gravel, rock, and peat. In addition, exploring for, developing, and extracting oil, gas, hydrocarbons, or petroleum products are all prohibited activities.
- vii. Dumping. Waste and unsightly or offensive material is not allowed and may not be accumulated in linear watercourses, non-linear waterbodies, wetlands and their associated buffers.
- viii. Water Courses. Linear watercourses, lakes, wetlands, or other bodies of water may not be altered unless the above permit is modified, altered or terminated by a subsequently issued permit for the Subject Property.
- ix. Off-Road Recreational Vehicles. Motorized off-road vehicles such as, but not limited to, snowmobiles, dune buggies, all-terrain vehicles, and motorcycles may not be operated off of designated roads on the linear watercourses, non-linear waterbodies, wetlands and their associated buffers.
- x. Signs and Billboards. Billboards are prohibited. Signs are prohibited, except the following signs may be displayed to state: The name and address of the property or the owner's name. The area is protected. Prohibition of any unauthorized entry or use. An advertisement for the sale or rent of the Property.

2. **Term.** This covenant is to run with the land and shall be binding on all parties and their successors and all persons claiming under them, and all public agencies, for a perpetual period from the date these covenants are recorded.

3. **Enforcement.** Enforcement shall be by proceedings at law or in equity against any person violating or threatening to violate any covenant either to restrain violation or to recover damages. Enforcement may be undertaken by any grantor or grantee in the chain of title, any property owner in the subdivision, any property owner lying downstream or upstream adversely effected by any violation or threat to violate this covenant, or the host community or Kane County Stormwater Management Planning Committee.
4. **Reference.** This restrictive covenant shall be referenced on all deeds or other instruments of conveyance for all lots or parcels in said \_\_\_\_\_ subdivision.

In Witness Whereof \_\_\_\_\_, the fee owner, has caused these presents to be signed and acknowledged, this \_\_\_\_\_ day of \_\_\_\_\_, 2\_\_\_\_.

\_\_\_\_\_  
By: \_\_\_\_\_

Declaration of Restriction and Covenant for Category I Stormwater Mitigation/Best Management Practices (BMPs)

STATE OF ILLINOIS )

) SS:

COUNTY OF KANE )

**STORMWATER MITIGATION/BEST MANAGEMENT PRACTICES (BMPS)  
RESTRICTIVE COVENANT BY PLAT**

\_\_\_\_\_, fee owner of the following described real property located in the \_\_\_\_\_, County of Kane, State of Illinois, such property being the real property now duly platted as \_\_\_\_\_, as such plat is now recorded as Document No. \_\_\_\_\_, in the office of the Recorder of Deeds of the County of Kane, State of Illinois, makes the following declarations as to limitations, restrictions and uses to which those areas designated as STORMWATER MITIGATION/BEST MANAGEMENT PRACTICES (BMPS) in said parcel/subdivision may be put, and specifies that such declarations shall constitute covenants to run with all the land, as provided by law, and shall be binding on all parties and their successors, and all persons claiming under them, and for the benefit of and limitations on all future owners in such parcel/subdivision and the surrounding and downstream and upstream areas, this declaration being in compliance with applicable stormwater and drainage rules, regulations, and ordinances as specified herein:

1. **Purpose:** The purpose of this restrictive covenant is to perpetually preserve the Volume reduction and Water Quality Treatment of permitted Stormwater Mitigation/Best Management Practices (BMPs). The obligations established by Stormwater Management Permit # \_\_\_\_\_ shall run with the land and remain in effect in perpetuity, or until said permit is modified, altered or terminated by a subsequently issued permit for the Subject Property.
2. **Prohibited Actions.** Any activity on, or use of, the Stormwater Mitigation/Best Management Practices (BMPs) which is inconsistent with the purpose of this covenant is expressly prohibited. By way of example, but not by way of limitation, the following activities and uses are explicitly prohibited:
  - i. **Construction.** The placement or construction of any human-made modification such as, but not limited to, buildings, fences, roads, and parking lots is prohibited unless a permit has been obtained.
  - ii. **Cutting Vegetation.** Any cutting of trees or vegetation, is prohibited, except for the cutting or removal of trees or vegetation which pose a threat to

human life or property or is part of the permitted long-term management plan.

- iii. Land Surface Alteration. Any alteration of the surface of the land is prohibited, including, but not limited to, the removal of topsoil, sand, gravel, and rock, except as necessary to maintain the design storage and function of the Stormwater Mitigation/Best Management Practice (BMP).
- iv. Dumping. Waste and unsightly or offensive material is not allowed and may not be accumulated in Stormwater Mitigation/Best Management Practices (BMPs).
- v. Off-Road Recreational Vehicles. Motorized off-road vehicles such as, but not limited to, snowmobiles, dune buggies, all-terrain vehicles, and motorcycles may not be operated off of designated roads on the linear watercourses, non-linear waterbodies, wetlands and their associated buffers.
- vi. Signs and Billboards. Billboards are prohibited. Signs are prohibited, except the following signs may be displayed to state: The name and address of the property or the owner's name. Prohibition of any unauthorized entry or use. An advertisement for the sale or rent of the Property.

2. **Term** This covenant is to run with the land and shall be binding on all parties and their successors and all persons claiming under them, and all public agencies, for a perpetual period from the date these covenants are recorded.

3. **Enforcement.** Enforcement shall be by proceedings at law or in equity against any person violating or threatening to violate any covenant either to restrain violation or to recover damages. Enforcement may be undertaken by any grantor or grantee in the chain of title, any property owner in the subdivision, any property owner lying downstream or upstream adversely effected by any violation or threat to violate this covenant, or the host community or Kane County Stormwater Management Planning Committee.

4. **Reference.** This restrictive covenant shall be referenced on all deeds or other instruments of conveyance for all lots or parcels in said \_\_\_\_\_ subdivision.

In Witness Whereof \_\_\_\_\_, the fee owner, has caused these presents to be signed and acknowledged, this \_\_\_\_\_ day of \_\_\_\_\_, 2\_\_\_\_.

\_\_\_\_\_  
By: \_\_\_\_\_

- 
- <sup>1</sup> Smith (2001); Smith (2003)
  - <sup>2</sup> JEGEL (2000)
  - <sup>3</sup> Smith (2001); Smith (2003)
  - <sup>4</sup> EPA (1999)
  - <sup>5</sup> Smith (2001); Smith (2003)
  - <sup>6</sup> Rollings *et al.* (1993)
  - <sup>7</sup> Schueler (1987); Horner *et al.* (1994); EPA (1998)
  - <sup>8</sup> Rollings *et al.* (1992)
  - <sup>9</sup> Borgwardt *et al.* (2000); Rollings *et al.* (1992); Yoder *et al.* (1975)
  - <sup>10</sup> Rollings *et al.* (1993)
  - <sup>11</sup> Smith (2001)
  - <sup>12</sup> Borgwardt *et al.* (2000)
  - <sup>13</sup> Dorman *et al.* (1964)
  - <sup>14</sup> Smith (2001)
  - <sup>15</sup> Borgwardt *et al.* (2000)
  - <sup>16</sup> Rollings *et al.* (1993)
  - <sup>17</sup> Smith (2001)
  - <sup>18</sup> Smith (2001)
  - <sup>19</sup> Smith (2001)
  - <sup>20</sup> Smith (2001)
  - <sup>21</sup> Dunn *et al.* (1980); Rollings *et al.* (1992); Borgwardt *et al.* (2000)
  - <sup>22</sup> Smith (2001)
  - <sup>23</sup> Smith (2001)
  - <sup>24</sup> Bean *et al.* (2004)
  - <sup>25</sup> Smith (2003); Borgwardt *et al.* (2000)
  - <sup>26</sup> Backstrom (2000)
  - <sup>27</sup> Hansen *et al.* (1997)
  - <sup>28</sup> EPA (1999)
  - <sup>29</sup> Mahabadi (2001)
  - <sup>30</sup> Cahill *et al.* (2004)
  - <sup>31</sup> Rollings *et al.* (1992)
  - <sup>32</sup> Borgwardt(1994); Bean *et al.* (2004)
  - <sup>33</sup> Bean *et al.* (2004)
  - <sup>1</sup> Barr Engineering Company (2001)
  - <sup>2</sup> Mahabadi (2001)
  - <sup>3</sup> Northern Virginia Planning Commission and Engineers and Surveyors Institute (1992); MA Department of Environmental Protection (1997); Lowndes, M.A. (2000); Los Angeles County Department of Public Works (2002)
  - <sup>1</sup> Schueler (1987); Northern Virginia Planning Commission and Engineers and Surveyors Institute (1992); Schueler *et al.* (1992)
  - <sup>2</sup> Schueler (1987)
  - <sup>3</sup> Schueler (1987); Lowndes (2000)
  - <sup>4</sup> WDNR (2004b)
  - <sup>5</sup> MA Department of Environmental Protection (1997); Lowndes (2000)
  - <sup>6</sup> Lowndes, M.A. (2000)
  - <sup>7</sup> WDNR (2004a)
  - <sup>8</sup> MA Department of Environmental Protection (1997)
  - <sup>9</sup> Schueler (1987); Horner *et al.* (1994); EPA (1998); Barr Engineering Company (2001)
  - <sup>10</sup> WDNR (2004b)



- 
- <sup>11</sup> Mahabadi (2001)  
<sup>12</sup> Schueler (1987); Lowndes (2000)  
<sup>13</sup> Mahabadi (2001)  
<sup>14</sup> Schueler (1987); Horner et al. (1994); EPA (1998); Barr Engineering Company (2001)  
<sup>15</sup> Schueler (1987); Northern Virginia Planning Commission and Engineers and Surveyors Institute (1992); Lowndes (2000)  
<sup>16</sup> Northern Virginia Planning Commission and Engineers and Surveyors Institute (1992)  
<sup>17</sup> Mahabadi (2001)  
<sup>18</sup> Mahabadi (2001)  
<sup>19</sup> Northern Virginia Planning Commission and Engineers and Surveyors Institute (1992); MA Department of Environmental Protection (1997); Los Angeles County Department of Public Works (2002); WDNR (2004b)  
<sup>20</sup> WDNR (2004b)  
<sup>21</sup> Mahabadi (2001)  
<sup>22</sup> MA Department of Environmental Protection (1997)  
<sup>23</sup> MA Department of Environmental Protection (1997)  
<sup>24</sup> Northern Virginia Planning Commission and Engineers and Surveyors Institute (1992)  
<sup>25</sup> Lowndes (2000)  
<sup>26</sup> Northern Virginia Planning Commission and Engineers and Surveyors Institute (1992)  
<sup>27</sup> Northern Virginia Planning Commission and Engineers and Surveyors Institute (1992); MA Department of Environmental Protection (1997); Los Angeles County Department of Public Works (2002)  
<sup>28</sup> Lowndes (2000)  
<sup>29</sup> Mahabadi (2001)
- <sup>1</sup> Yu *et al.* (1992)  
<sup>2</sup> Schueler (1987); Northern Virginia Planning Commission and Engineers and Surveyors Institute (1992); Lowndes (2000)  
<sup>3</sup> Lowndes (2000)  
<sup>4</sup> Price *et al.* (1998)  
<sup>5</sup> Horner (1993); NRCS-II (2001); Los Angeles County Department of Public Works (2002)  
<sup>6</sup> Price *et al.* (1998); NRCS-II (2001)  
<sup>7</sup> Price *et al.* (1998)  
<sup>8</sup> USDA (1994)  
<sup>9</sup> Schueler *et al.* (1992); Price *et al.* (1998)  
<sup>10</sup> Price *et al.* (1998); Lowndes (2000)  
<sup>11</sup> Schueler (1987); NRCS-II (2001)  
<sup>12</sup> Price *et al.* (1998)  
<sup>13</sup> Price *et al.* (1994)  
<sup>14</sup> Price *et al.* (1998)  
<sup>15</sup> Price *et al.* (1998)  
<sup>16</sup> Northern Virginia Planning Commission and Engineers and Surveyors Institute (1992); NRCS-II (2001)  
<sup>17</sup> USDA (1994)  
<sup>18</sup> Schueler (1987)  
<sup>19</sup> Northern Virginia Planning Commission and Engineers and Surveyors Institute (1992)  
<sup>20</sup> Lowndes (2000)  
<sup>21</sup> NRCS-II (2001)  
<sup>22</sup> Minton (2005)  
<sup>23</sup> Price *et al.* (1998)  
<sup>24</sup> Price *et al.* (1998)  
<sup>25</sup> Md DNR ((1984)

- 
- 26 Price *et al.* (1998)
  - 27 Price *et al.* (1998)
  - 28 NRCS-II (2001)
  - 29 NRCS-II (2001)
  - 30 NRCS-II (2001)
  - 31 Price *et al.* (1998)
  - 32 Price *et al.* (1998)
  - 33 Price *et al.* (1998)
  - 34 Price *et al.* (1998)
  - c Barr Engineering Company (2001)
  - ci MA Department of Environmental Protection (1997); Barr Engineering Company (2001); Schueler (1992)
  - cii NIPC (2000)
  - ciii MA Department of Environmental Protection (1997); Barr Engineering Company (2001); Schueler (1992)
  - civ EPA (1999)
  - cv EPA (1999)
  - cvi MA Department of Environmental Protection (1997); NIPC (2000)
  - cvii NIPC (2000)
  - cviii MA Department of Environmental Protection (1997); Barr Engineering Company (2001)
  - cix NIPC (2000)
  - cx Barr Engineering Company (2001)
  - cxii EPA (1999)
  - cxiii NIPC (2000)
  - cxiv NIPC (2000)
  - cxv Schueler (1992)
  - 19 Schueler (1992)

## AASHTO MAXIMUM WIDTH FOR LINEAR PROJECTS REFERENCES

The references below are provided as reference to TABLE 9-81 for Linear Projects. The roadway chart is derived from the AASHTO 2004 manual. The latest edition AASHTO Policy on Geometric Design of Highways & Streets, Seventh Edition, 2018 does not contain the chart below, however the maximum lane width is unchanged so for the purpose of determining the maximum width, the 2004 chart is provided below.

### Ranges for Lane Width

Type of Roadway	Rural		Urban	
	US (feet)	Metric (meters)	US (feet)	Metric (meters)
Freeway	12	3.6	12	3.6
Ramps (1-lane)	12-30	3.6-9.2	12-30	3.6-9.2
Arterial	11-12	3.3-3.6	10-12	3.0-3.6
Collector	10-12	3.0-3.6	10-12	3.0-3.6
Local	9-12	2.7-3.6	9-12	2.7-3.6

(Source: A Policy on Geometric Design of Highways and Streets, AASHTO)

The AASHTO Guide for the Development of Bicycle Facilities 2012, 4<sup>th</sup> Edition diagrams are provided on the following page for on street and shared use paths as reference for the maximum AASHTO widths for trails.

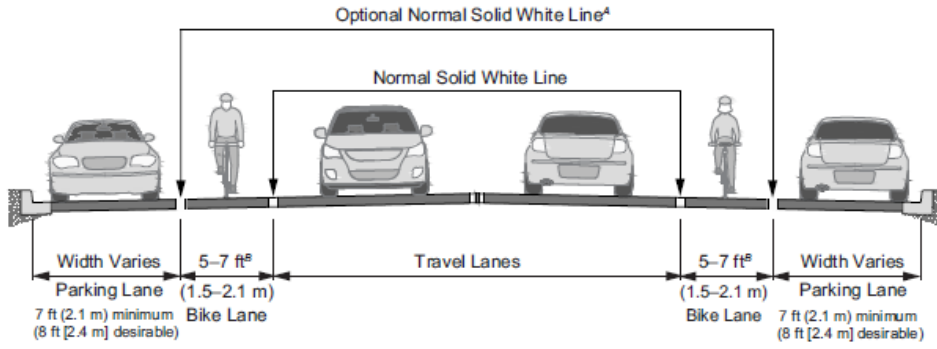

**On Street Parking**

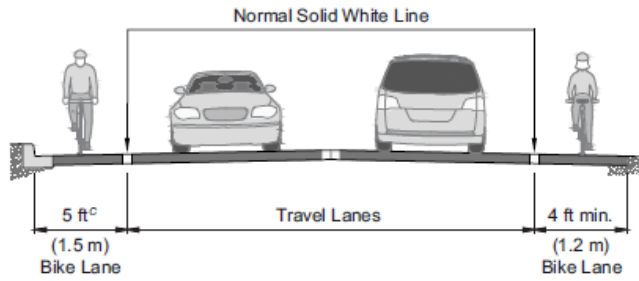

**Parking Prohibited**

- On steep grades to provide additional passing area; or
- Through curves to provide more operating space.

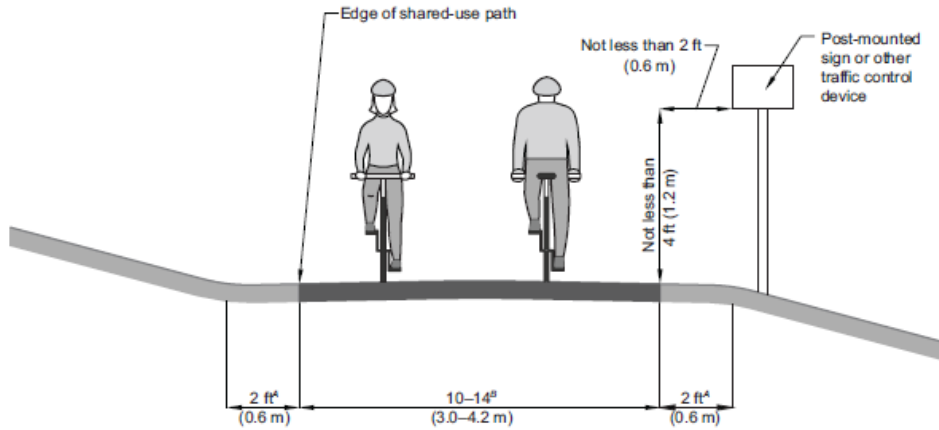

**Notes:**

<sup>A</sup> (1V:6H) Maximum slope (typ.)

<sup>B</sup> More if necessary to meet anticipated volumes and mix of users, per the *Shared Use Path Level of Service Calculator* (9)

**Figure 5-1. Typical Cross Section of Two-Way, Shared Use Path on Independent Right-of-Way**

## **Falling Head Percolation Test Procedure<sup>1</sup>**

### **Number and Location of Tests**

Commonly a minimum of three percolation tests are performed within the area proposed for an absorption system. They are spaced uniformly throughout the area. If soil conditions are highly variable, more tests may be required.

### **Preparation of Test Hole**

The diameter of each test hole is 6-inches, dug or bored to the proposed depths at the infiltration systems or to the most limiting soil horizon. To expose a natural soil surface, the sides of the hole are scratched with a sharp pointed instrument and the loose material is removed from the bottom of the test hole. Two-inches of  $\frac{1}{2}$ - to  $\frac{3}{4}$ -inch gravel are placed in the hole to protect the bottom for scouring action when the water is added.

### **Soaking Period**

The hole is carefully filled with at least 12-inches of clear water. This depth of water should be maintained for at least 4-hours and preferably overnight if clay soils are present. A funnel with an attached hose or similar device may be used to prevent water from washing down the sides of the hole. Automatic siphons or float valves may be employed to automatically maintain the water level during the soaking period. It is extremely important that the soil be allowed to soak for a sufficiently long period of time to allow the soil to swell if accurate results are to be obtained.

In sandy soils with little or no clay, soaking is not necessary. If, after filling the hole twice with 12-inches of water, the water seeps completely away in less than 10-minutes, the test can proceed immediately.

### **Measurement of the Percolation Rate**

Except for sandy soils, percolation rate measurements are made 15-hours but not more than 30-hours after the soaking period began. Any soil that sloughed into the hole during the soaking period is removed and the water level is adjusted to 6-inches above the gravel (or 8-inches above the bottom of the hole). At no time during the test is the water level allowed to rise more than 6-inches above the gravel.

After each measurement, the water level is readjusted to the 6-inches level. The last water level drop is used to calculate the percolation rate.

In sandy soils or soils in which the first 6-inches of water added after the soaking period seep away in less than 30-minutes, water level measurements are made at 10-minute intervals for a 1-hour period. The last water level drop is used to calculate the percolation rate.

### Calculation of the Percolation Rate

The percolation rate is calculated for each test hole by dividing the time interval used between measurements by the magnitude of the last water level drop. This calculation results in a percolation rate in terms of minutes/inch. To determine the percolation rate for the area, the rates obtained from each hole are averaged. (if tests in the area vary by more than 20-minutes/inch variations in soil type are indicated. Under these circumstances, percolation rates should not be averaged.)

Example: if the last measurement drop in water level after 30-minutes is 5/8-inch the percolation rate = (30-minutes)/(5/8-inch)= 48-minutes/inch.

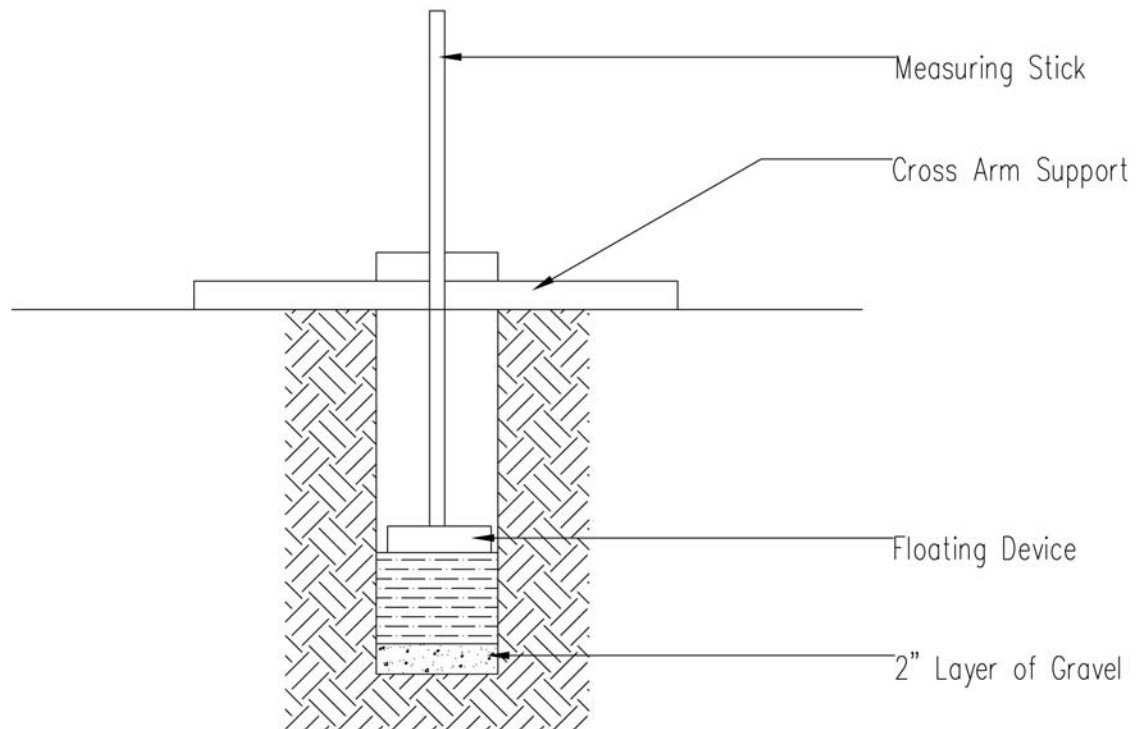

---

<sup>1</sup> Design Manual – Onsite Wastewater Treatment and Disposal System, EPA, 1980

### Percolation Test Data Form

Location:	
Test hole #:	

Depth to bottom of hole:		Diameter of hole:	
--------------------------	--	-------------------	--

Depth, inches	Soil texture

Percolation test by:	
Date of test:	

Time	Time intervals, minutes	Measurement, inches	Drop in water level, inches	Percolation rate, minutes per inch	Remarks

Percolation rate =		minutes per inch
--------------------	--	------------------